

INDUSTRIAL WIRE ROPE SUPPLY COMPANY, INC.





Industrial Wire Rope Supply Company, Inc.

All Your Industrial Needs Worldwide

Call Toll Free - Cincinnati, Ohio (888) 345-0919

St. Charles, Missouri (866) 852-9714

Valued Customer,

Industrial Rope Supply Company, Inc. has undergone many changes since the start of 2016. Industrial Rope was purchased by Barry Stroube and John Korn to supplement their existing company, American Scaffolding, Inc. Barry and John are committed to maintaining a family owned business and providing customers with the same exceptional service they have come to expect. The staff has remained the same at both locations, Industrial Wire Rope Supply Company, Inc. is now located at 7390 Harrison Avenue, Cincinnati, Ohio 45247.

Our product line continues to expand to meet the demands of our customer. A wire rope press was added to offer our customers a complete line of fabricated wire rope products. In addition to the products shown in our catalog, we offer a full line of safety products, fiber rope, small cordage, galvanized air cord, import wire rope, import fittings, bulk chain, chain slings, and all related chain products. We pride ourselves in providing our customers with the best service in the industry.

If you are a customer who has used our service, we thank you for your continued support. If you are new to our company please take a moment to browse through our catalog. We will be happy to answer any questions that may arise.

Thank you.

Cincinnati Division

7390 Harrison Avenue
Cincinnati, Ohio 45247
Phone: (513) 941-2443
Fax: (513) 941-2445
Toll Free: (888) 345-0919

St. Charles Division

2086 Exchange Drive
St. Charles, Missouri 63303
Phone: (636) 255-0600
Fax: (636) 255-0602
Toll Free: (866) 852-9714



Large Inventory Covering A Full Line of Products

Industrial Wire Rope Supply Co., Inc., maintains a large inventory of wire rope in all diameters and constructions to meet the needs and expectations of the market.

In addition, Industrial Wire Rope Supply Co., Inc. offers a complete range of wire rope slings, nylon slings, chain, shackles, thimbles, sockets, and other related hardware.

As a distributor for all manufacturers of wire rope and most manufacturers of rigging and hoisting equipment, we are able to provide prompt delivery of all products by utilizing their stocks from all around the country.

Full Range of Equipment and Services

- Proof testing on hardware and wire rope beyond 2,000,000 pounds
- Destruction test performed beyond 1,000,000 pounds 2-1/4" diameter wire rope
- Direct distribution with our own modern truck fleet
- Field inspections and consulting

Quality and Service – Our Number One Priority

We have the opportunity to deal with a wide variety of successful companies in multiple industries, our key to growth has been to provide the products they need with the quality they demand and the service we know they deserve. This includes technical support that comes from a knowledgeable sales staff totalling over 200 years experience in wire rope.

Our ability to provide “one-stop shopping” means our customers can rely on Industrial Wire Rope Supply Co., Inc. for all their demands and prompt reliable service.



Wire Rope



Wire Rope Fittings

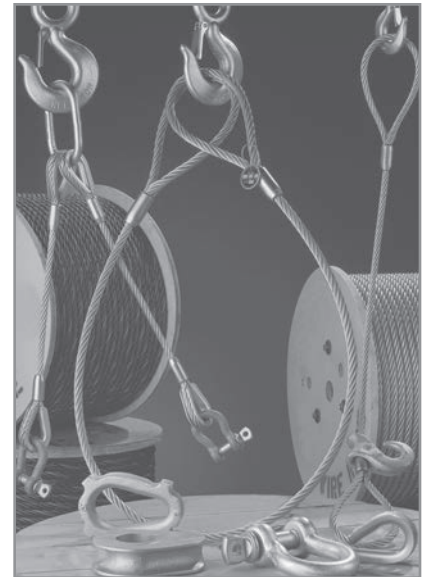

Wire Rope Slings

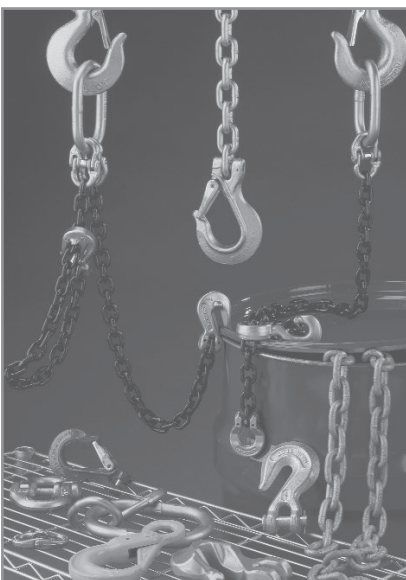

Chain



Synthetic Web Slings



Miscellaneous Equipment



ST. CHARLES, MO • CINCINNATI, OH

***WE CAN SUPPLY ALL THE RIGGING
YOU NEED FOR LIFTING,
LOADING AND LASHING!***

BLOCKS

CHAIN

Alloy - G80 & G100
Anchor
Boomer - G70
Hi-Test - G43
Hoist
Proof Coil - G30
Tail Chains

CLIPS

Drop Forged
Fist Grip
Malleable

COLD SHUTS

CORDAGE

Manila
Nylon
Poly
HMPE

FENCING

Orange Plastic
Wire Rope
SILT Barriers

HOOKS

LINKS

LOAD BINDERS

PENDANTS

SHACKLES

Alloy
Carbon
Lifting
Round Pin Anchor
Round Pin Chain
Safety Anchor
Safety Chain
Screw Pin Anchor
Screw Pin Chain
Stainless Steel
Towing
Trawling
Wide Body

SHEAVES

SLINGS

Chain
Fiber Rope
Nylon web
Polyester Round
Steel Mesh
Synthetic Web
Wire Rope

SOCKETS

Bridge
Spelter
Strand
Swage
Wedge

SWIVELS

Ball Bearing
Chain
Jaw End

THIMBLES

Bronze
Crescent
Equalizing
Fiber Rope
Hawser
Heavy Duty
Regular
Slip-On
Slip-Thru
Solid
Stainless
Towing

TURNBUCKLES

Stainless Steel
Galvanized

WIRE ROPE

Aircraft Cable
Cable-Laid
Drill Line
Galvanized
Mooring Line
Rotation Resistant
Sandline
Stainless Steel
Trawl Cable
Domestic
Import

CONTENTS

- 1 Wire Rope** 4
 - Specifications & Capacities5-23
 - Nominal Strengths of Wire Rope24-27
 - Compacted Strand Wire Rope28
 - Metric Crane Ropes.....29
 - Aircraft Cables30
 - Strand31
 - Vinyl Coated32
- 2 Wire Rope Fittings** 33
 - Wire Rope Clips34-35
 - Sockets.....36-38
 - Shackles39-48
 - Wire Rope Thimbles49-50
 - Wire Rope Swaged Sockets.....51
 - Wire Rope Spelter Sockets52-53
 - Turnbuckles54-55
 - Eyebolts56-57
 - Hooks & Latches58-67
 - Steel Links68-69
 - Swivels.....70-71
- 3 Wire Rope Slings**..... 72
 - Type 11 Slings73-75
 - Type 21 Slings76
 - Type 31 Slings77
 - Type 41 Slings78
 - Type 12 Slings79
 - Type 16 Slings80
 - Type 18 Slings81-82
 - Type 19 Slings83
 - Choker Slings84-85
 - Grommet Slings.....86-87
- 4 Chain** 88
 - Alloy Chain Slings.....89-90
 - Chain Sling Configurations91-94
 - Grade 100 Working Load Limit 95
 - Eliminator96-97
 - Grade 100 Chain Hardware 98-107
 - Connecting Links 108-110
 - Chain Hooks 111-112
 - Load Binders..... 113-116
 - Grade 80 Sling Configuration 117-118
 - Other Chain 119
- 5 Synthetic Web Slings**120
 - Specifications & Capacities.....121-124
 - Capacities.....125-130
 - Tiedowns 131
 - Fall Protection..... 132

All specifications included herein are subject to change without notice.

CONTENTS

- 6 Miscellaneous Equipment**.....133
 - Hoists & Come-a-longs 134
 - Overhaul Balls.....135-136
 - Snatch Blocks137-144
 - Vertical Clamps.....145-146
 - Pipe Grabs & Beam Clamps.....147-151
 - Spreader Bar 152
 - Custom Orders153-158
- 7 Cordage & Pull Tape**159
 - 3-Strand.....160
 - Double Braid Polyester..... 161
 - Double Braid Nylon 162
 - Amsteel® Blue 163
 - Herculine® Pull Tape..... 164



**INDUSTRIAL WIRE ROPE
SUPPLY COMPANY INC.**

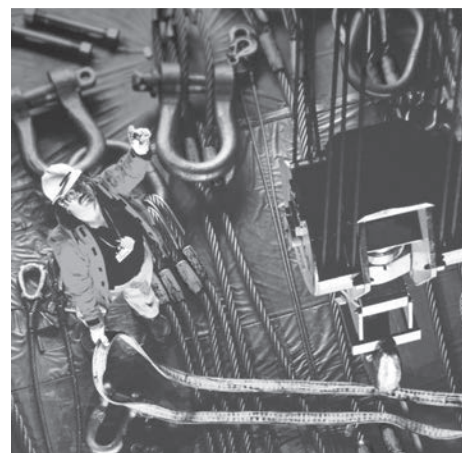

1

2

3

4

5

6

7

3

Wire Rope

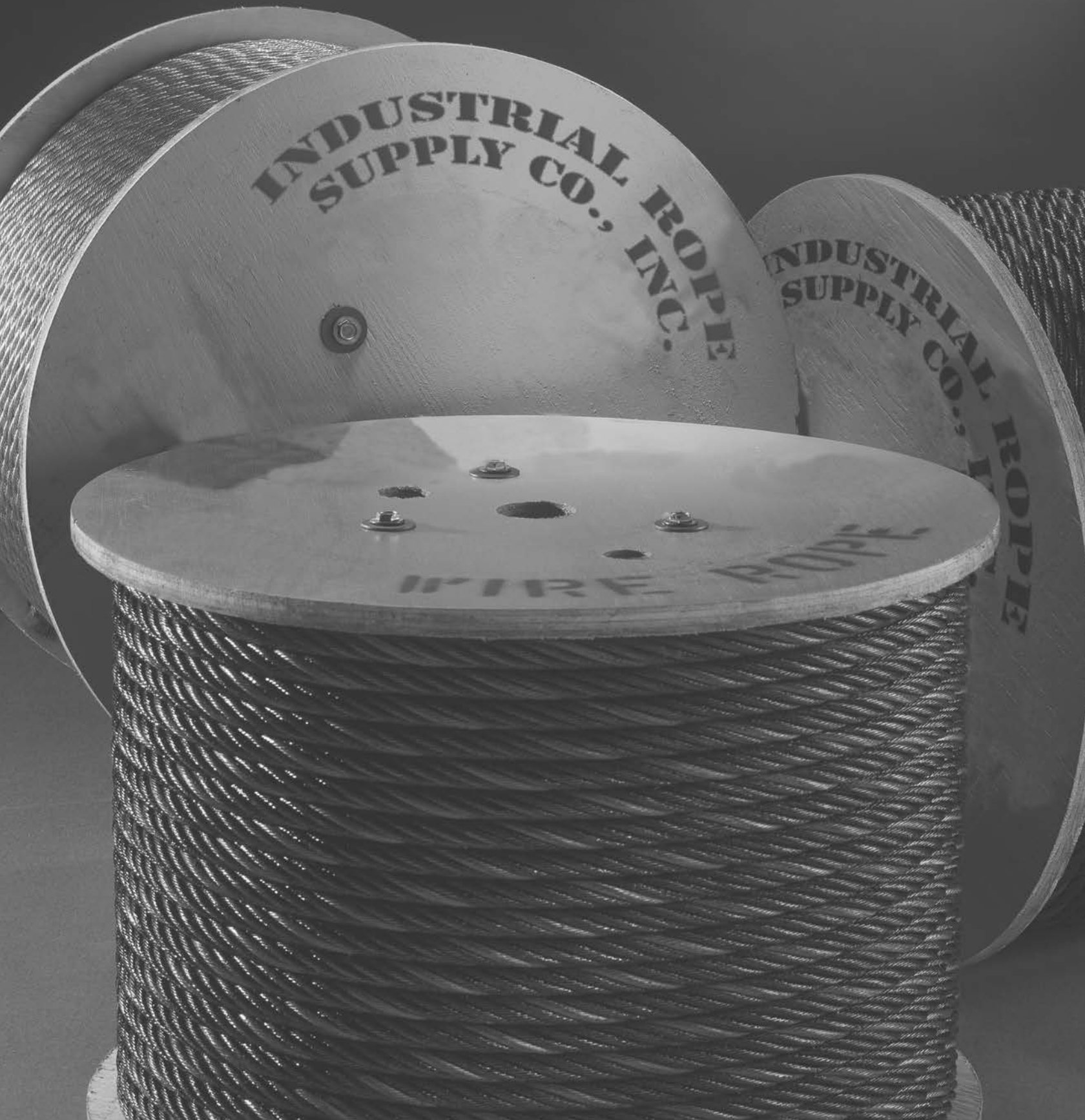



Wire Rope: Popular Classifications



Left Lay REGULAR LAY

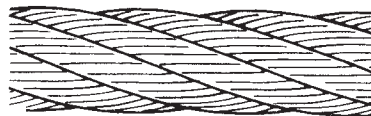

Right Lay REGULAR LAY

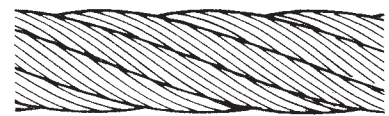

Right Lay LANG LAY

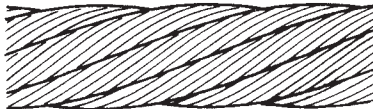

Left Lay LANG LAY

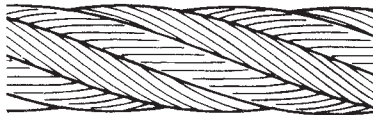

Alternate Lay

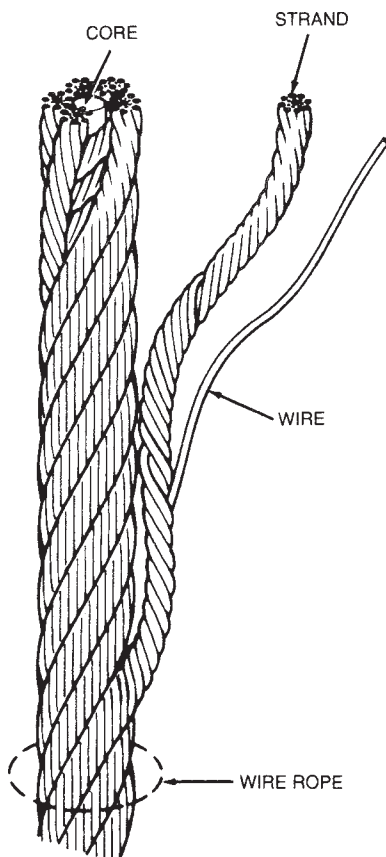

BASED ON THE NOMINAL NUMBER OF WIRES IN EACH STRAND

Classification	Description
6 × 7	Containing 6 strands that are made up of 3 through 14 wires, of which no more than 9 are outside wires.
6 × 19	Containing 6 stands that are made up of 15 through 26 wires, of which no more than 12 are outside wires.
6 × 37	Containing 6 strands that are made up of 27 through 49 wires, of which no more than 18 are outside wires.
6 × 61	Containing 6 strands that are made up of 50 through 74 wires, of which no more than 24 are outside wires.
6 × 91	Containing 6 strands that are made up of 75 through 109 wires, of which no more that 30 are outside wires.
6 × 127	Containing 6 strands that are made up of 110 or more wires, of which no more than 36 are outside wires.
8 × 19	Containing 8 strands that are made up of 15 through 26 wires, of which no more than 12 are outside wires.
19 × 7 and 18 × 7	Containing 19 strands, each strand is made up of 7 wires. It is manufactured by covering an inner rope of 7 × 7 left lang lay construction with 12 strands in right regular lay. (The rotation-resistant property that characterizes this highly specialized construction is a result of the counter torques developed by the two layers.) When the steel wire core strand is replaced by a fiber core, the decription becomes 18 × 7.

When a center wire is replaced by a strand, it is considered as a single wire, and the rope classification remains unchanged.

There are, of course, many other types of wire rope, but they are useful only in a limited number of applications and, as such, are sold as specialties.



Wire Rope Specifications

TYPES OF CENTERS

An important point to consider is the selection of the proper type center to be needed in the rope. Wire Ropes are made with either fiber core or steel wire core.

1) Fiber Center (FC)

This center is made of either natural fibers or polypropylene and offers greater elasticity than the Independent Wire Rope Core.

2) Independent Wire Rope Core (IWRC)

This center is usually composed of a separate 7×7 wire rope designated as IWRC. The steel core increases the strength by 7% and the weight by 10%. These steel cores provide more substantial support than fiber cores to the outer strands during the rope's operating life. Steel centers resist crushing, are more resistant to heat and increase the strength of the rope.

SAFETY FACTOR

The Safety Factor being the ratio between the minimum Breaking load of the rope and the safe working load (SWL) tells at what percentage of its ultimate strength a wire rope is operating. The Safety Factor takes into consideration both normal rope wear and potential stresses in various applications. The best practice in determining an adequate safety factor is to analyze the specific conditions involved in each individual installation. The following example shows how to determine the Safety Factor: If a rope is working under a max. operating load of 10,000 lbs and is having an ultimate strength of 50,000 lbs the factor is 5 which means it is operating at 20% of its ultimate strength.

FLEET ANGLE

The fleet angle is the angle formed between the rope running to or from the extreme left or right of the drum and a line drawn from the center of the sheave normal to the axis of the drum. For optimum efficiency, the angle here should not exceed $1\frac{1}{2}^\circ$ for a smooth drum, or 2° for a grooved drum. If the fleet angle is larger than the recommended limits it can cause bad winding on smooth drums and rubbing against the flanges of the sheave grooves. Too small a fleet angle should also be avoided since it will cause the rope to pile up against the flange head.

Before installing any wire rope that winds onto a drum, the fleet angle should be checked and if found improper, conditions should be corrected.

SHEAVE ALIGNMENT

Proper alignment of sheaves is essential. The main sheave should line up with the center of the hoisting drum, otherwise both the rope and sheave flanges will be subjected to severe wear and rapid deterioration will occur. If rope speeds are high sheaves should also be balanced.

NOTE:

Wire rope products will break if abused, misused or overused.
Regular inspection and maintenance are necessary.
Consult industry recommendations and OSHA standards before using.



Wire Rope

SUGGESTED WIRE ROPE FOR PARTICULAR USES

Preformed or Form-Set construction is used for all ropes shown.

USE	SIZE (IN.)	CONSTRUCTION	LAY	CORE	GRADE
Clamshell					
Holding & Closing Lines	1/2—1 1/4	6 x 25 FW or 6 x 36 WS	RRL	IWRC	EIPS
Boom Hoist Line	1/2 & Up	6 x 25 FW	RRL	IWRC	EIPS
Tag Line	1/4 & 5/16	6 x 36 WS	RRL	FIBER	EIPS
	3/8 & Up	6 x 41 WS	RRL	FIBER	EIPS
Crawler & Truck Cranes					
Hoist Line	1/2—1 1/4	6 x 25 FW or 19 x 7 RR	RRL	IWRC	EIPS
Boom Hoist Line	All	6 x 25 FW	RRL	IWRC	EIPS
Whip Line	3/8—1 1/4	19 x 7 RR	RRL	IWRC	EIPS
Cranes & Hoists					
Overhead	1/4—7/16	6 x 19 S or 6 x 36 WS	RRL	IWRC	EIPS
	1/2—1	6 x 36 WS	RRL	IWRC	EIPS
	1 1/8 & Up	6 x 41 WS	RRL	IWRC	EIPS
Ladle Crane	1/2—1	6 x 36 WS	RRL	IWRC	EIPS
	1 1/8 & Up	6 x 41 WS	RRL	IWRC	EIPS
Dragline					
Hoist Line	Up To 1 1/4	6 x 25 FW or 8 x 25	RLL	IWRC	EIPS
	1 3/8 & Up	6 x 41 WS or 8 x 25, 8 x 36	RLL	IWRC	EIPS
Drag Line	3/4—1 1/2	6 x 21 FW or 8 x 25	RLL	IWRC	EIPS
	1 5/8—3	6 x 25 FW or 8 x 36	RLL	IWRC	EIPS
	3 & Up	6 x 41 WS or 8 x 36	RLL	IWRC	EIPS
Boom Hoist	1/2 & Up	6 x 25 FW or 8 x 25	RRL	IWRC	EIPS
Shovels					
Hoist Line	Up To 1 1/8	6 x 25 FW or 8 x 25	RLL	IWRC	EIPS
	1 1/4 & Up	6 x 41 WS or 8 x 25	RLL	IWRC	EIPS
Crowd & Retract Boom Hoist	3/4 & Up	6 x 41 WS or 8 x 25	RLL	IWRC	EIPS
	1/2—1 1/4	6 x 25 FW or 8 x 25	RRL	IWRC	EIPS
Trip Rope	1 3/8 & Up	6 x 41 WS or 8 x 25	RRL	IWRC	EIPS
	3/8—1 1" & Up	6 x 36 WS or 8 x 25 6 x 41 WS or 8 x 25	RRL RRL	FIBER FIBER	IPS IPS
Logging Ropes					
Chokers	All	6 x 26 WS or 6 x 25 FW	RRL	IWRC	EIPS
Winch Lines	All	6 x 26 WS or 6 X 25 FW	RRL	IWRC	EIPS
Mining					
Slope Rope	All	6 x 19 S or 6 x 21 FW	RLL	FIBER	IPS
Shaft Hoist Ropes	All	6 x 19 S or 6 x 25 FW	RLL or RRL	FIBER	IPS
Slusher Rope	All	3 x 19 S or 6 x 19 S	RRL	IWRC	IPS
Mining Machine Rope	All	6 x 36 WS or 6 x 41 WS	RRL	IWRC	EIPS



SUGGESTED WIRE ROPE FOR PARTICULAR USES

Preformed or Form-Set construction is used for all ropes shown.

USE	SIZE (IN.)	CONSTRUCTION	LAY	CORE	GRADE
Marine Ropes					
Towing Hawser	All	6 x 41 WS	RRL	F.C. or IWRC	EIPS
Mooring Lines	All	6 x 24 S or 6 x 41 WS	RRL	F.C. or IWRC	EIPS
Cargo Falls	All	6 x 36 WS	RRL	IWRC	EIPS
Oil Field					
Rotary Drill Lines	3/4-1 1/2	6 x 19 S or 6 x 21 S	RRL	IWRC	EIPS
Sand Lines	All	6 x 7	RRL	POLY	IPS
Tubing Line	All	6 x 26 WS or 19 x 7 RR	RRL or LRL	IWRC	EIPS
Cable Tool Line	All	6 x 21 S	LRL	POLY	IPS
Offshore					
Rotary Drill Lines	1-1 3/4	6 x 19 S	RRL	IWRC	EIPS
Riser Tensioner Lines	1 1/4-2	6 x 41 WS	RLL	IWRC	IPS
Guide Lines	1/2-1	6 x 25FW	RRL	IWRC	IPS
Sand Lines	1/2-5/8	6 x 7	RRL	FIBER	IPS
Pendant Lines	1 1/2-3	6 x 25 FW or 6 x 37 WS	RRL	IWRC	EIPS
Crane-Main Hoist	3/8-2	6 x 25 FW or 6 x 37 WS	RRL	F.C. or IWRC	IPS or EIPS
Crane-Auxiliary Hoist	3/8-2 1/4	19 x 7 RR or 36 x 7 RR	RRL	IWRC	EIPS
Anchor Lines	1 3/8-6	6 x 37 WS through 6 x 91	RRL	IWRC	EIPS
Heavy Lift Slings	1 1/2-4	6 x 37 WS	RRL	IWRC	EIPS
Cable Laid Heavy Lift Slings	3 1/2-10	7 x 6 x 41	RLL or LLL	IWRC	EIPS

Definition of Abbreviations

Grade	Construction	Lay	Core
IPS - Improved Plow Steel	FW - Filler Wire	RRL - Right Regular Lay	IWRC - Wire Rope Core
EIPS - Extra Improved Plow Steel	WS - Warrington Seale	RLL - Right Lang Lay	FC - Fiber Core
GIPS - Galvanized Improved Plow Steel	SFW - Seale Filler Wire	LRL - Left Regular Lay	Fiber - Hemp or Poly Core
	RR - Rotation Resistant	LLL - Left Lang Lay	Poly - Polypropylene Core
	W - Warrington		
	S - Seale		



DIAGNOSTIC GUIDE TO COMMON WIRE ROPE DEGRADATION

Mode	Symptoms	Possible Causes
Fatigue	Wire break is transverse—either straight across or Z shape. Broken ends will appear grainy.	Check for rope bent around too small a radius; vibration or whipping; wobbly sheaves; rollers too small; reverse bends; bent shafts; tight grooves; corrosion; small drums & sheaves; incorrect rope construction; improper installation; poor end terminations. (In the absence of other modes of degradation, all rope will eventually fail in fatigue.)
Tension	Wire break reveals a mixture of cup and cone fracture and shear breaks.	Check for overloads; sticky, grabby clutches; jerky conditions; loose bearing on drum; fast starts, fast stops, broken sheave flange; wrong rope size & grade; poor end terminations. Check for too great a strain on rope after factors of degradation have weakened it.
Abrasion	Wire break mainly displays outer wires worn smooth to knife edge thinness. Wire broken by abrasion in combination with another factor will show a combination break.	Check for change in rope or sheave size; change in load; overburden change; frozen or stuck sheaves; soft rollers, sheaves or drums; excessive fleet angle; misalignment of sheaves; kinks; improperly attached fittings; grit & sand; objects imbedded in rope; improper grooving.
Abrasion plus Fatigue	Reduced cross-section is broken off square thereby producing a chisel shape.	A long term condition normal to the operating process.
Abrasion plus Tension	Reduced cross-section is necked down as in a cup and cone configuration. Tensile break produces a chisel shape.	A long term condition normal to the operating process.
Cut or Gouged or Rough Wire	Wire ends are pinched down, mashed and/or cut in a rough diagonal shear-like manner.	Check on all the above conditions for mechanical abuse, or either abnormal or accidental forces during installation.
Torsion or Twisting	Wire ends show evidence of twist and/or cork-screw effect.	Check on all the above conditions for mechanical abuse, or either abnormal or accidental forces during installation.
Mashing	Wires are flattened and spread at broken ends.	Check on all the above conditions for mechanical abuse, or either abnormal or accidental forces during installation. (This is a common occurrence on the drum.)
Corrosion	Wire surfaces are pitted with break showing evidence either of fatigue tension or abrasion.	Indicates improper lubrication or storage, or a corrosive environment.



1 Figuring Reel Capacity

SHIPPING REEL CAPACITY

While it is virtually impossible to calculate the precise length of wire rope that can be spooled on a reel or drum, the following formula provides a sufficiently close approximation.

The formula* is: $L = (A+D) \cdot A \cdot B \cdot K$

- where: L = length of rope (ft)
- A = depth of rope space on drum (inches)
- B = width of drum between flanges (inches)
- D = drum barrel diameter (inches)
- K = constant for given rope diameter (see table below)
- H = diameter of reel flanges (inches)
- x = clearance

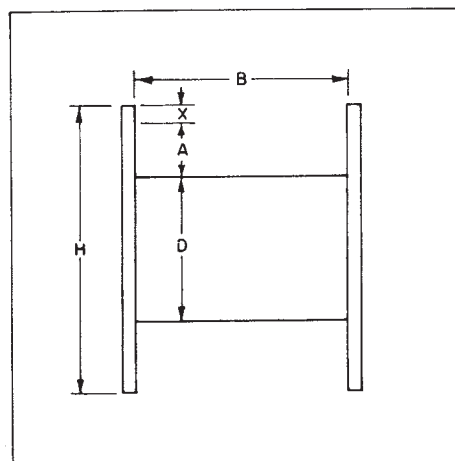

“K” FACTORS**

$(0.2618 \div \text{rope diameter}^2)$

Diam. (inches)	K	Diam. (inches)	K	Diam. (inches)	K
1/16	49.8	1/2	0.925	1 3/8	0.127
3/32	23.4	9/16	0.741	1 1/2	0.107
1/8	13.6	5/8	0.607	1 5/8	0.0886
5/32	8.72	1 1/16	0.506	1 3/4	0.0770
3/16	6.14	3/4	0.428	1 7/8	0.0675
7/32	4.59	1 3/16	0.354	2	0.0597
1/4	3.29	7/8	0.308	2 1/8	0.0532
5/16	2.21	1	0.239	2 1/4	0.0476
3/8	1.58	1 1/8	0.191	2 3/8	0.0419
7/16	1.19	1 1/4	0.152	2 1/2	0.0380

*This formula is based on uniform rope winding on the reel. It will not give correct results if the winding is non-uniform. The formula also assumes that there will be the same number of wraps of rope in each layer. While this is not strictly correct, there is no appreciable error in the result unless the traverse of the reel is quite small relative to the flange diameter (“H”).

**The values given for “K” factors take normal rope oversize into account. Clearance (“x”) should be about 2 inches unless rope-end fittings require more.



Choosing the right rope for your application

With each application, your choices of wire ropes can be many. How do you know which one works best for you? Ropes include a combination of properties that give them specific performance abilities. Before you choose, it pays to look closely at each rope's special properties.

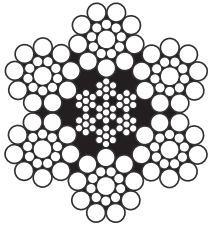

IF YOU NEED ABRASION RESISTANCE

- > Abrasion resistance increases with fewer, larger outside wires per strand.

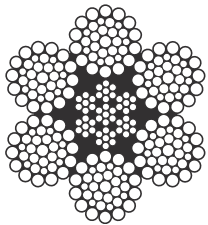

IF YOU NEED FATIGUE RESISTANCE

- > Fatigue resistance increases with more, smaller outside wires per strand.

NO SINGLE WIRE ROPE CAN DO IT ALL

All wire ropes feature design property tradeoffs. In most cases, a wire rope cannot increase both fatigue resistance and abrasion resistance. For example, when you increase fatigue resistance by selecting a rope with more wires, the rope will have less abrasion resistance because of its greater number of smaller outer wires.

When you need wire rope with greater abrasion resistance, one choice is a rope with fewer (and larger) outer wires to reduce the effects of surface wear. But that means the rope's fatigue resistance will decrease. That's why you need to choose your wire rope like you would any other machine. Very carefully. You must consider all operating conditions and rope properties.

THE BASIC PROPERTIES OF WIRE ROPE

How do you choose the wire rope that's best suited for your job? Following are the most common properties to be considered when selecting a rope for an application.

STRENGTH Wire rope strength is usually measured in tons of 2,000 lbs. In published material, wire rope strength is shown as minimum breaking force (MBF) or nominal (catalog)

strength. These refer to calculated strength figures that have been accepted by the wire rope industry.

When placed under tension on a test device, a new rope should break at a figure equal to – or higher than – the minimum breaking force shown for that rope.

The values in this handbook apply to new, unused rope. A rope should never operate at – or near – the minimum breaking force. During its useful life, a rope loses strength gradually due to natural causes such as surface wear and metal fatigue.

FATIGUE RESISTANCE Fatigue resistance involves metal fatigue of the wires that make up a rope. To have high fatigue resistance, wires must be capable of bending repeatedly under stress – for example, a rope passing over a sheave.

Increased fatigue resistance is achieved in a rope design by using a large number of wires. It involves both the basic metallurgy and the diameters of wires.

In general, a rope made of many wires will have greater fatigue resistance than a same-size rope made of fewer, larger wires because smaller wires have greater ability to bend as the rope passes over sheaves or around drums. To reduce the effects of fatigue, ropes must never bend over sheaves or drums with a diameter so small as to bend wires excessively. There are precise recommendations for sheave and drum sizes to properly accommodate all sizes and types of ropes.



Every rope is subject to metal fatigue from bending stress while in operation, and therefore the rope's strength gradually diminishes as the rope is used.

CRUSHING RESISTANCE Crushing is the effect of external pressure on a rope, which damages it by distorting the cross-section shape of the rope, its strands or core – or all three.

Crushing resistance therefore is a rope's ability to withstand or resist external forces, and is a term generally used to express comparison between ropes.

When a rope is damaged by crushing, the wires, strands and core are prevented from moving and adjusting normally during operation.

In general, IWRC ropes are more crush resistant than fiber core ropes. Regular lay ropes are more crush resistant than lang lay ropes. Six strand ropes have greater crush resistance than 8 strand ropes or 19 strand ropes. Flex-X® ropes are more crush resistant than standard round-strand ropes.

RESISTANCE TO METAL LOSS AND DEFORMATION Metal loss refers to the actual wearing away of metal from the outer wires of a rope, and metal deformation is the changing of the shape of outer wires of a rope.

In general, resistance to metal loss by abrasion (usually called "abrasion resistance") refers to a rope's ability to withstand metal being worn away along its exterior. This reduces strength of a rope.

The most common form of metal deformation is generally called "peening" – since outside wires of a peened rope appear to have been "hammered" along their exposed surface.

Peening usually occurs on drums, caused by rope-to-rope contact during spooling of the rope on the drum. It may also occur on sheaves.

Peening causes metal fatigue, which in turn may cause wire failure. The hammering – which causes the metal of the wire to flow into a new shape – realigns the grain structure of the metal, thereby affecting its fatigue resistance. The out-of-round shape also impairs wire movement when the rope bends.

RESISTANCE TO ROTATION When a load is placed on a rope, torque is created within the rope as wires and strands try to straighten out. This is normal and the rope is designed to operate with this load-induced torque. However, this torque can cause loads to rotate. Load-induced torque can be reduced by specially designed rotation resistant ropes.

In standard 6 and 8 strand ropes, the torques produced by the outer strands and the IWRC is in the same direction and add together. In rotation resistant ropes, the lay of the outer strands is in the opposite direction to the lay of the inner strands, thus the torques produced are in opposite directions and the torques subtract from each other.

Depending upon your application, other wire rope properties such as stability, bendability or reserve strength may need to be considered.

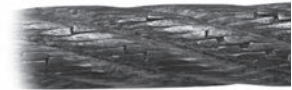

"SQUARED ENDS"

> Typical example of breaks due to fatigue.



"CRUSHING"

> Typical example of external pressure on a wire rope.

CROSS-SECTION OF A WORN WIRE

- > Original cross-section
- > Worn surface

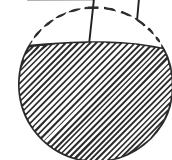

CROSS-SECTION OF A PEENED WIRE

- > Original cross-section
- > Peened surface

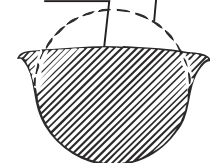



How to measure wire rope diameter

The actual diameter of a wire rope is the diameter of a circumscribed circle that will enclose all the strands. It's the largest cross-sectional measurement as shown here. You should make the measurement carefully with calipers.

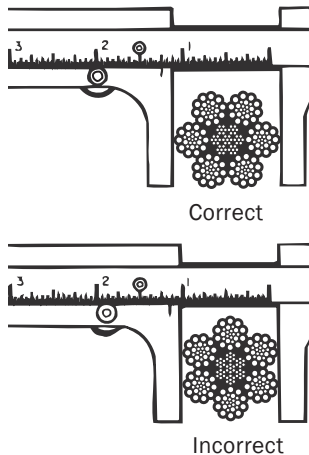
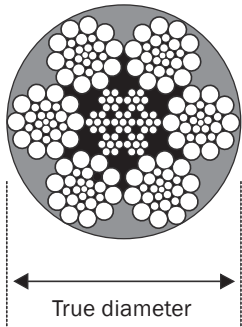

The illustrations at left show the correct and incorrect methods of measuring wire ropes with even numbers of outer strands.

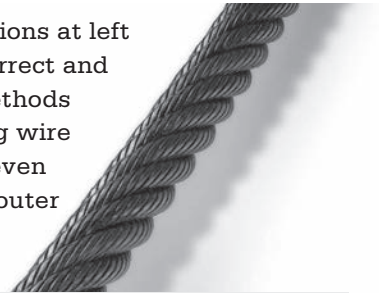

Metric conversion and equivalents

As we move toward metric measurements, it will become increasingly necessary to convert English units into SI - International System of Units - (or metrics), and vice versa. The following table and conversion factors are included in this handbook to help you.

ROPE DIAMETER

For standard, general purpose wire ropes, in measuring diameter, the industry is leaning toward a "soft" conversion to metric during the transition period. For example, a 1" diameter rope converts to 25.4 mm in metrics. Using the soft conversion, this is changed to the whole metric size that most nearly parallels the 1" size range, or 26 mm. In sizes smaller than 5/8", the rope diameter is rounded to the nearest 0.5 mm.

STRENGTHS AND WEIGHTS

The following table gives the closest equivalent metric diameters for rope sizes up through 5 inches. Again, these metric sizes are based on the industry's "soft" conversion. Your application may have tighter tolerances that require a hard conversion. Therefore, the values in the table would not apply.

Since rope minimum breaking force and weight per unit of length vary for different types and grade of ropes, the following conversion factors are given to help you convert the figures you need:

- > To convert rope weight in pounds per foot (lb/ft) to kilograms per meter (kg/m), multiply by 1.488.

Nominal wire rope diameter

Inches	Millimeters	Inches	Millimeters
1/4	6.5	2 1/8	54
5/16	8	2 1/4	58
3/8	9.5	2 3/8	60
7/16	11.5	2 1/2	64
1/2	13	2 5/8	67
9/16	14.5	2 3/4	71
5/8	16	2 7/8	74
3/4	19	3	77
7/8	22	3 1/8	80
1	26	3 1/4	83
1 1/8	29	3 3/8	87
1 1/4	32	3 1/2	90
1 3/8	35	3 3/4	96
1 1/2	38	4	103
1 5/8	42	4 1/4	109
1 3/4	45	4 1/2	115
1 7/8	48	4 3/4	122
2	52	5	128

- > To convert rope minimum breaking force in tons (T) to kilonewtons (kN), multiply by 8.897; 1 lb equals 4.448 newtons (N).
- > To convert rope minimum breaking force in tons (T) to kilograms (kg), multiply by 907.2.

Note: The newton (a unit of force) is the correct unit for measurement of minimum breaking force in the SI system of units. We have included a conversion factor from tons to kilograms because a rope's minimum breaking force is often referred to in terms of kilograms (a unit of mass).



ALLOWABLE TOLERANCE IN WIRE ROPE DIAMETER

Wire rope is normally made slightly larger than its catalog (or nominal) size. The following chart lists the size tolerances of standard wire rope.

Nominal Diameter (in)	Tolerance		Nominal Diameter (mm)
	Under	Over	
Through 1/8	-0	+ 8%	From 2 to <4
Over 1/8 through 3/16	-0	+ 7%	From 4 to <6
Over 3/16 through 5/16	-0	+ 6%	From 6 to < 8
Over 5/16 and larger	-0	+ 5%	8 and greater

Design factors

The design factor is defined as the ratio of the minimum breaking force of a wire rope to the total load it is expected to carry.

Use of design factors provides rope installations with reasonable assurance of adequate capacity for the work to be done throughout a rope's service life. Considerations in establishing design factors include the type of service, design of equipment and consequences of failure.

In most applications, the selection of a rope based on the proper design factor has been made by the equipment manufacturer. In an application where a different rope is to be used, or in a new application, check government and industry regulations for the required design factor. Different rope

types on the same application may have different design factor requirements.

HOW TO USE DESIGN FACTORS

Standards and regulations require that design factors be applied to the rope's minimum breaking force to determine the maximum working load. To determine the maximum working load for which an operating rope may be used, divide the rope's minimum breaking force by the required design factor. This is the rope's maximum working load. There may be other limiting factors in an application that make the maximum load the equipment can handle less than the rope's maximum working load.*

Remember, an installation is only at the prescribed design factor when the rope is new. As a rope is used, it loses strength and literally is "used up."



*NOTE

- > The rated capacity of a wire rope sling incorporates both a design factor and a splicing or attachment efficiency.

How to extend rope service life

How long will your rope last? There is not a simple answer but, rather, there are several factors involved, including:

- > The manner in which you install and “break in” your new rope.
- > The operating technique and work habits of the machine operators.
- > Physical maintenance of the rope throughout its service life.
- > Physical maintenance of the system in which your rope operates.



AVOID TWISTING OF NEW WIRE ROPE DURING INSTALLATION

- > Handle the rope properly from the reel or coil to your equipment and, on smooth-faced drums, spool with wraps tight and close together on the first layer.

RECOMMENDED PRACTICES

We’ve outlined several recommended practices you may use to extend your rope’s useful life. It’s also important to note that all sections of this handbook, in some respect, also review ways to help you get greater useful life from your rope, and that’s why you need to thoroughly understand all the material here.

INSTALL YOUR ROPE CORRECTLY

The primary concern when installing a new rope is to not trap any twist in the rope system. Proper handling of the rope from the reel or coil to your equipment will help avoid this situation. Another important step on smooth faced drums is to spool with tensioned wraps tight and close together on the first layer. This layer forms the foundation for succeeding layers. Finally, spool the remaining rope on the drum with tension approximating 1% to 2% of the rope’s minimum breaking force.

BREAK IN YOUR NEW ROPE PROPERLY

When you install a new operating rope, you should first run it for a brief period of time with no load. Then, for best results, run it under controlled loads and speeds to enable the wires and strands in the rope to adjust to themselves.

“CONSTRUCTIONAL” STRETCH

When first put into service, new ropes normally elongate while strands go through a process of seating with one another and with the rope core. This is called “constructional” stretch because it is inherent in the construction of the rope, and the amount of elongation may vary from one rope to another. For standard ropes, this stretch will be about 1/4% to 1% of the rope’s length.

When constructional stretch needs to be minimized, ropes may be factory prestretched. Please specify when placing your order.

Another type of stretch, “elastic” stretch, results from recoverable elongation of the metal itself.

CUT OFF ENDS TO MOVE WEAR POINTS

If you observe wear developing in a localized area, it may be beneficial to cut off short lengths of rope. This may require an original length slightly longer than you normally use. When severe abrasion or numerous fatigue breaks occur near one end or at any one concentrated area – such as drag ropes on draglines or closing lines in clamshell buckets, for example – the movement of this worn section can prolong rope life.

CLEAN AND LUBRICATE REGULARLY TO REDUCE WEAR

We lubricate our wire rope during manufacture so that the strands – as well as the individual wires in the strands – may move and adjust as the rope moves and bends. But no wire rope can be lubricated sufficiently during manufacture to last its entire life. That’s why it’s important to lubricate periodically throughout the life of the rope.

The surface of some ropes may become covered with dirt, rock dust or other material during their operation. This can prevent field-applied lubricants from properly penetrating into the rope, so it’s a good practice to clean these ropes before you lubricate them.

The lubricant you apply should be light-bodied enough to penetrate to the rope’s core. You can normally apply lubricant by using one of three methods: drip it on rope, spray it on or brush it on. In all cases, you

should apply it at a place where the rope is bending, such as around a sheave. We recommend you apply it at the top of the bend because that’s where the rope’s strands are spread by bending and more easily penetrated. In addition, there are pressure lubricators available commercially. Your rope’s service life will be directly proportional to the effectiveness of the method you use and the amount of lubricant that reaches the rope’s working parts.

A proper lubricant must reduce friction, protect against corrosion and adhere to every wire. It should also be pliable and not crack or separate when cold – yet not drip when warm. Never apply heavy grease to the rope because it can trap excessive grit, which can damage the rope. Nor should you apply used “engine oil” because it contains materials that can damage the rope. For unusual conditions, you can specify special lubricants that we can apply at the factory.

Wire breaks from vibration fatigue occur at end terminations, so short lengths cut off there with reattachment of the socket may prolong the rope’s life. When broken wires are found, you should cut off sections of rope. In the case of a socket, you should cut off at least five or six feet. In the case of clips or clamps, you should cut off the entire length covered by them.

Where there is an equalizing sheave, such as that found in many overhead cranes, fatigue is localized at rope tangency points to the equalizing sheave. Rope life may be increased if you shift this point by cutting off a short length at the end of one of the drums. Be sure to make this cutoff

before significant wear occurs at the equalizing sheave, and always do so at the same drum. You must maintain the required minimum number of dead wraps on the drum.

REVERSING ENDS

Frequently, the most severe deterioration occurs at a point too far from the end or is too long to allow the worn section to be cut off. In such cases, you may turn the rope end for end to bring a less worn section into the area where conditions are most damaging. This practice is beneficial for incline rope and draglines. The change must be made well before the wear reaches the removal criteria. When changing ends, be careful to avoid kinking or otherwise damaging the rope.



THREE METHODS OF APPLYING LUBRICATION:

> Drip

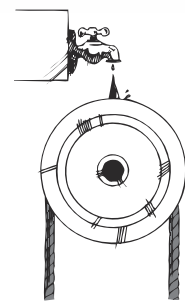

> Spray

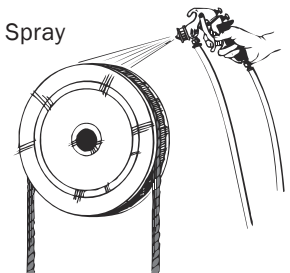

> Brush

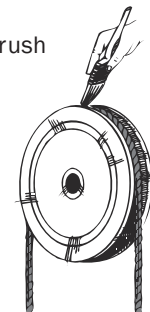

Wire rope wear, abuse - and removal criteria

1

All wire ropes will wear out eventually and gradually lose work capability throughout their service life. That's why periodic inspections are critical. Applicable industry standards such as ASME B30.2 for overhead and gantry cranes or federal regulations such as OSHA refer to specific inspection criteria for varied applications.



INSPECT YOUR WIRE ROPE REGULARLY

> Inspection should be performed by a person with special training or practical experience.

THREE PURPOSES FOR INSPECTION

Regular inspection of wire rope and equipment should be performed for three good reasons:

- > It reveals the rope's condition and indicates the need for replacement.
- > It can indicate if you're using the most suitable type of rope.
- > It makes possible the discovery and correction of faults in equipment or operation that can cause costly accelerated rope wear.

HOW OFTEN

All wire ropes should be thoroughly inspected at regular intervals. The longer it has been in service or the more severe the service, the more thoroughly and frequently it should be inspected. Be sure to maintain records of each inspection.

APPOINT A QUALIFIED PERSON TO INSPECT

Inspections should be carried out by a person who has learned through special training or practical experience what to look for and who knows how to judge the importance of any abnormal conditions they may discover. It is the inspector's responsibility to obtain and follow the proper inspection criteria for each application inspected.

For information on inspection methods and techniques, our Techreport 107: Wire Rope Inspection, is available on the unionrope.com website for download. If you need further assistance with our ropes, contact our Product Engineering Department.





Rope Wear

Deterioration and Abuse

- 1. Mechanical damage due to rope movement over sharp edge projection whilst under load.



- 2. Localised wear due to abrasion on supporting structure. Vibration of rope between drum and jib head sheave.



- 3. Narrow path of wear resulting in fatigue fractures, caused by working in a grossly oversize groove, or over small support rollers.



- 4. Two parallel paths of broken wires indicative of bending through an undersize groove in the sheave.



- 5. Severe wear, associated with high tread pressure. Protrusion of fibre main core.

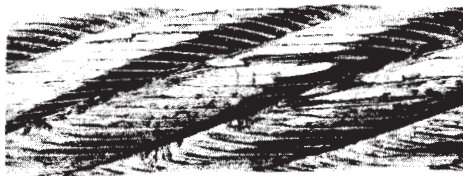

- 6. Severe wear in Lang Lay, caused by abrasion of cross-over points on multi-layer coiling application.



- 7. Corrosion of severe degree caused by immersion of rope in chemically treated water.



Rope Wear

Deterioration and Abuse

8. Typical wire fractures as a result of bend fatigue.



9. Wire fractures at the strand, or core interface, as distinct from 'crown' fractures, caused by failure of core support.



10. Break up of IWRC resulting from high stress application. Note nicking of wires in outer strands.

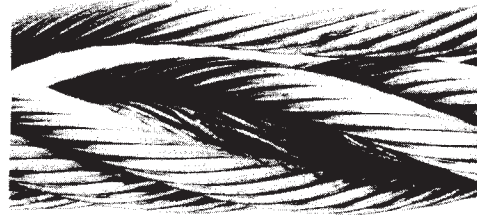

11. Strand core protusion as a result of torsional unbalance created by 'drop ball' application. (i.e. shock loading).

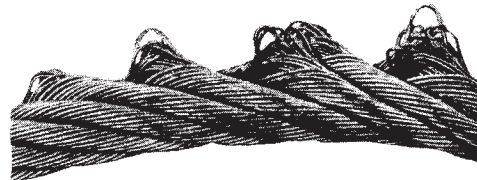

12. Typical example of localised wear and deformation created at a previously kinked portion of rope.



13. Multi strand rope 'bird-caged' due to torsional unbalance. Typical of build up seen at anchorage end of multi-fall crane application.



14. Protusion of IWRC resulting from shock loading.

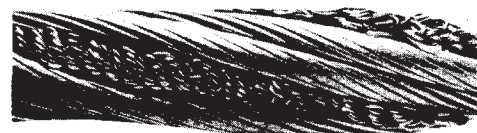



WHAT TO LOOK FOR



Here's what happens when a **wire breaks** under tensile load exceeding its strength. It's typically recognized by the "cup and cone" appearance at the point of failure. The necking down of the wire at the point of failure to form the cup and cone indicates failure has occurred while the wire retained its ductility.

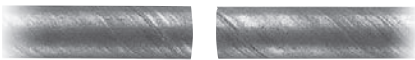

This is a wire with a distinct **fatigue break**. It's recognized by the square end perpendicular to the wire. This break was produced by a torsion machine that's used to measure the ductility. This break is similar to wire failures in the field caused by fatigue.

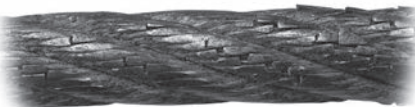

Shown here is a wire rope that has been subjected to repeated bending over sheaves under normal loads. This results in **fatigue breaks** in individual wires – these breaks are square and usually in the crown of the strands.



This is an example of **fatigue failure** of a wire rope subjected to heavy loads over small sheaves. The breaks in the valleys of the strands are caused by "strand nicking." There may be crown breaks, too.

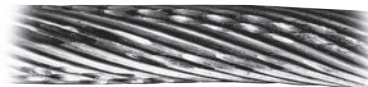

Here you see a single strand removed from a wire rope subjected to **strand nicking**. This condition is a result of adjacent strands rubbing against one another. While this is normal in a rope's operation, the nicking can be accentuated by high loads, small sheaves or loss of core support. The ultimate result will be individual wire breaks in the valleys of the strands.



Wire rope wear, abuse - and removal criteria

TYPICAL EVIDENCE OF WEAR AND ABUSE



KNOW WHEN TO REMOVE YOUR WIRE ROPE

> The chart on the facing page offers a guide for removal, based on the number of wires involved.



A “**birdcage**” is caused by sudden release of tension and the resulting rebound of rope. These strands and wires will not be returned to their original positions. The rope should be replaced immediately.

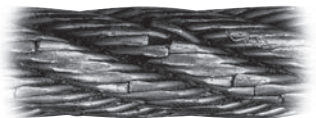

This shows a typical failure of a rotary drill line with a poor cutoff practice. These wires have been subjected to continued **peening**, causing fatigue type failures. A predetermined, regularly scheduled cutoff practice can help eliminate this type of problem.



This is **localized wear** over an equalized sheave. The danger here is that it's invisible during the rope's operation, and that's why you need to inspect this portion of an operating rope regularly. The rope should be pulled off the sheave during inspection and bent to check for broken wires.



This is a wire rope with a **high strand** – a condition in which one or more strands are worn before adjoining strands. This is caused by improper socketing or seizing, kinks or dog-legs. At top, you see a closeup of the concentration of wear. At bottom, you see how it recurs every sixth strand in a 6 strand rope.



A **kinked wire rope** is shown here. It's caused by pulling down a loop in a slack line during handling, installation or operation. Note the distortion of the strands and individual wires. This rope must be replaced.

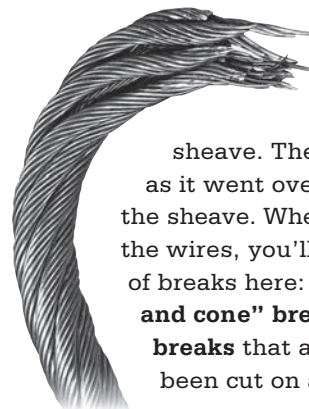

Here's a wire rope that has jumped a sheave. The rope “**curled**” as it went over the edge of the sheave. When you study the wires, you'll see two types of breaks here: **tensile “cup and cone” breaks** and **shear breaks** that appear to have been cut on an angle.



Drum crushing is caused by small drums, high loads and multiple winding conditions.



REMOVAL CRITERIA

A major portion of any wire rope inspection is the detection of broken wires. The number and type of broken wires are an indication of the rope's general condition and a benchmark for its replacement.

Frequent inspections and written records help determine the rate at which wires are breaking. Replace the rope when the values given in the table below are reached.

Valley wire breaks – where the wire fractures between strands or a broken

wire protrudes between strands – are treated differently than those that occur on the outer surface of the rope. When there is more than one valley break, replace the rope.

Broken wire removal criteria cited in many standards and specifications, like those listed below, apply to wire ropes operating on steel sheaves and drums. For wire ropes operating on sheaves and drums made with material other than steel, please contact the sheave, drum or equipment manufacturer or a qualified person for proper broken wire removal criteria.

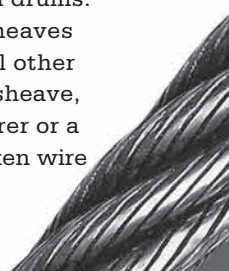

WHEN TO REPLACE WIRE ROPE – BASED ON NUMBER OF BROKEN WIRES

Standard	Equipment	Rope Type	# OF BROKEN WIRES IN RUNNING ROPES			# OF BROKEN WIRES IN STANDING ROPES	
			In one rope lay	In one strand	At end connection	In one rope lay	At end connection
ASME B30.2	Overhead and Gantry Cranes	All	12**	4	2	N/A	N/A
ASME B30.3	Construction Tower Cranes	Standard	12**	4	3	Not specified	3
		Rotation-resistant	2 randomly distributed broken wires in 6 rope diameters or 4 randomly distributed broken wires in 30 rope diameters**	N/A	3	N/A	3
ASME B30.4	Portal and Pedestal Cranes	Standard	6**	3	2	3	2
		Rotation-resistant	2 randomly distributed broken wires in 6 rope diameters or 4 randomly distributed broken wires in 30 rope diameters**	N/A	2	N/A	N/A
ASME B30.5	Mobile and Locomotive Cranes	Standard	6**	3	Not specified	3	2
		Rotation-resistant	2 randomly distributed broken wires in 6 rope diameters or 4 randomly distributed broken wires in 30 rope diameters**	N/A	Not specified	N/A	N/A
ASME B30.6	Derricks	Standard†	6**	3	Not specified	3	2
ASME B30.7	Winches	Standard	6 randomly distributed broken wires in 6 rope diameters or 3 broken wires in one strand in 6 rope diameters**	N/A	Not specified	N/A	N/A
		Rotation-resistant	2 randomly distributed broken wires in 6 rope diameters or 4 randomly distributed broken wires in 30 rope diameters**	N/A	Not specified	N/A	N/A
ASME B30.8	Floating Cranes and Floating Derricks	Standard	6 randomly distributed broken wires in 6 rope diameters or 3 broken wires in one strand in 6 rope diameters**	N/A	Not specified	3	2
		Rotation-resistant	2 randomly distributed broken wires in 6 rope diameters or 4 randomly distributed broken wires in 30 rope diameters**	N/A	Not specified	N/A	N/A
ASME B30.16	Overhead Hoists (Underhung)	Standard	6 randomly distributed broken wires in 6 rope diameters or 3 randomly distributed broken wires in 6 rope diameters**	N/A	2	N/A	N/A
		Rotation-resistant	2 randomly distributed broken wires in 6 rope diameters or 4 randomly distributed broken wires in 30 rope diameters**	N/A	2	N/A	N/A
ASME B30.29	Self-Erecting Tower Cranes	Standard	6**	3	3	3	2
		Rotation-resistant	2 randomly distributed broken wires in 6 rope diameters or 4 randomly distributed broken wires in 30 rope diameters**	N/A	3	N/A	N/A
ANSI A10.4	Personnel Hoists	All	6**	3	Not specified	Not specified	Not specified
ANSI A10.5	Material Hoists	All	6**	3		2**	1

** Also remove for 1 valley break
† Contact technical service engineering regarding rotation-resistant ropes





How to unreel, uncoil and store wire rope

CORRECT WAYS TO UNREEL AND UNCOIL WIRE ROPE

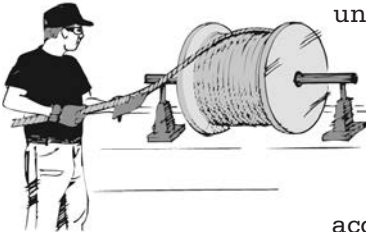

THE RIGHT WAY TO UNREEL AND UNCOIL A WIRE ROPE

There is always a danger of kinking a wire rope if you improperly unreel or uncoil it. You should mount a reel on jacks or a turntable so that it will revolve as you pull the rope off. Apply sufficient tension by means of a board acting as a brake against the reel flange to keep slack from accumulating. With a coil, stand it on edge and roll it in a straight line away from the free end. You may also place a coil on a revolving stand and pull the rope as you would from a reel on a turntable.

THE THREE STAGES OF KINKING



1. The start: A rope should never be allowed to accumulate twist as shown here because it will loop and eventually form a kink. If this loop is removed before being pulled down tight, you can normally avoid the kink.



2. The kink: By now, the damage is done, and the rope must not be used.



3. The result: Even if the wires do not appear badly damaged, the rope is still damaged and must be replaced.

HOW TO STORE WIRE ROPE PROPERLY

We recommend you store your wire rope under a roof or a weatherproof covering so that moisture cannot reach it. Similarly, you must avoid acid fumes or any other corrosive atmosphere – including ocean spray – in order to protect the rope from rust. If you're storing a reel for a lengthy period, you may want to order your rope with a protective wrap. If not, at least coat the outer layers of rope with a good rope lubricant.

If you ever take a rope out of service and want to store it for future use, you should place it on a reel after you've thoroughly cleaned and relubricated it. Give the same storage considerations to your used rope as you would your new rope.

Be sure to keep your wire rope in storage away from steam or hot water pipes, heated air ducts or any other source of heat that can thin out lubricant and cause it to drain out of your rope.

If a twist develops, remove the twist from the rope before a kink can form.





1

Wire Rope

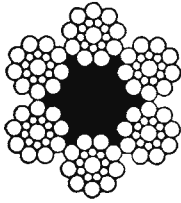

6 x 19 SEALE

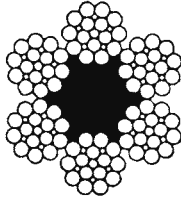

6 x 21 FILLER WIRE

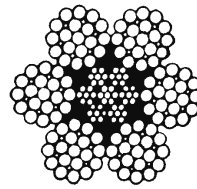

6 x 25 FILLER WIRE

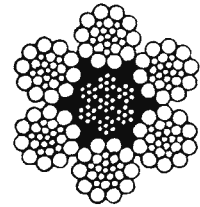

6 x 26
WARRINGTON-SEALE

NOMINAL STRENGTHS OF WIRE ROPE

6 x 19 Classification/Bright (Uncoated), or Drawn-Galvanized, Fiber Core, IPS

Nom. Diam.	Nominal Strength	Approx. Mass
	Improved Plow Steel	
inches	tons	lb/ft
¼	2.74	0.11
⅜	4.26	0.16
½	6.10	0.24
⅝	8.27	0.32
¾	10.70	0.42
⅞	13.50	0.53
1	16.70	0.66
1 ¼	23.80	0.95
1 ½	32.20	1.29
1 ¾	41.80	1.68
2	52.60	2.13
2 ¼	64.60	2.63
2 ½	77.70	3.18
2 ¾	92.00	3.78
3	107.00	4.44
3 ¼	124.00	5.15
3 ½	141.00	5.91
4	160.00	6.72

6 x 19 Classification/Bright (Uncoated), or Drawn-Galvanized, IWRC, EIPS

Nom. Diam.	Nominal Strength	Approx. Mass
	Extra Improved Plow Steel	
inches	tons	lb/ft
¼	3.40	0.12
⅜	5.27	0.18
½	7.55	0.26
⅝	10.20	0.35
¾	13.30	0.46
⅞	16.80	0.59
1	20.60	0.72
1 ¼	29.40	1.04
1 ½	39.80	1.42
1 ¾	51.70	1.85
2	65.00	2.34
2 ¼	79.90	2.89
2 ½	96.00	3.50
2 ¾	114.00	4.16
3	132.00	4.88
3 ¼	153.00	5.67
3 ½	174.00	6.50
4	198.00	7.39
4 ¼	221.00	8.35
4 ½	247.00	9.36
5	274.00	10.40
5 ½	302.00	11.60

(Meets or exceeds federal specification RR-W-410 [latest revision].)

*To convert to Kilonewtons (kN), multiply tons (nominal breaking strength) by 8.896; 1 lb = 4.448 newtons (N).

For Hot-Dipped Galvanized Strengths, Deduct 10%.



Wire Rope

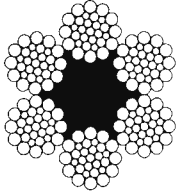

6 x 31
WARRINGTON SEALE

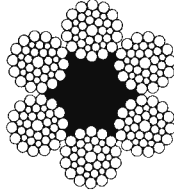

6 x 36
WARRINGTON SEALE

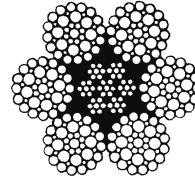

6 x 41 SFW
SEALE FILLER WIRE

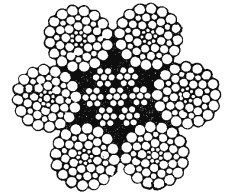

6 x 49 SWS
SEALE WARRINGTON
SEALE

NOMINAL STRENGTHS OF WIRE ROPE

6 x 37 Classification/Bright (Uncoated), or Drawn-Galvanized, Fiber Core, IPS

Nom. Diam.	Nominal Strength	Approx. Mass
	Improved Plow Steel	
inches	tons	lb/ft
1/4	2.74	0.11
5/16	4.26	0.16
3/8	6.10	0.24
7/16	8.27	0.32
1/2	10.70	0.42
5/8	13.50	0.53
3/4	16.70	0.66
7/8	23.80	0.95
1	32.20	1.29
1 1/8	41.80	1.68
1 1/4	52.60	2.13
1 3/8	64.60	2.63
1 1/2	77.70	3.18
1 5/8	92.00	3.78
1 3/4	107.00	4.44
1 7/8	124.00	5.15
2	141.00	5.91
2 1/4	160.00	6.72

6 x 37 Classification/Bright (Uncoated), or Drawn-Galvanized, IWRC, EIPS

Nom. Diam.	Nominal Strength	Approx. Mass
	Extra Improved Plow Steel	
inches	tons	lb/ft
1/4	3.40	0.12
5/16	5.27	0.18
3/8	7.55	0.26
7/16	10.20	0.35
1/2	13.30	0.46
5/8	16.80	0.59
3/4	20.60	0.72
7/8	29.40	1.04
1	39.80	1.42
1 1/8	51.70	1.85
1 1/4	65.00	2.34
1 3/8	79.90	2.89
1 1/2	96.00	3.50
1 5/8	114.00	4.16
1 3/4	132.00	4.88
1 7/8	153.00	5.67
2	174.00	6.50
2 1/4	198.00	7.39
2 1/2	221.00	8.35
2 3/4	247.00	9.36
3	274.00	10.40
3 1/4	302.00	11.60
3 1/2	331.00	12.80
3 3/4	361.00	14.00
4	392.00	15.30
4 1/4	425.00	16.60
4 1/2	458.00	18.00
4 3/4	492.00	19.50
5	529.00	21.00
5 1/4	564.00	22.70

Meets or exceeds federal specification RR-W-410 (latest revision).

*To convert to Kilonewtons (kN), multiply tons (nominal breaking strength) by 8.896; 1 lb = 4.448 newtons (N).
For Hot-Dipped Galvanized Strengths, Deduct 10%.



Wire Rope

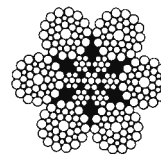

6 X 36
WARRINGTON-SEALE

Specifications per API 9A

6 x 37 Classification Wire Rope Bright (Uncoated) or Drawn-Galvanized Wire, Independent Wire Rope Core (IWRC)

Nominal Diameter	Approx. Mass	Nominal Strength					
		Improved Plow Steel (IPS)		Extra Improved Plow Steel (EIPS)		Extra Extra Improved Plow Steel (EEIPS)	
		lb	kN	lb.	kN	lb	kN
In.	lb/ft						
1/2	0.46	23,000	102	26,600	118	29,200	130
9/16	0.59	29,000	129	33,600	149	37,000	165
5/8	0.72	35,800	159	41,200	183	45,400	202
3/4	1.04	51,200	228	58,800	262	64,800	288
7/8	1.42	69,200	308	79,600	354	87,600	389
1	1.85	89,800	399	103,400	460	113,800	506
1 1/8	2.34	113,000	503	130,000	578	143,000	636
1 1/4	2.89	138,800	617	159,800	711	175,800	782
1 3/8	3.50	167,000	743	192,000	854	212,000	943
1 1/2	4.16	197,800	880	228,000	1010	250,000	1112
1 5/8	4.88	230,000	1020	264,000	1170	292,000	1300
1 3/4	5.67	266,000	1180	306,000	1360	338,000	1500
1 7/8	6.50	304,000	1350	348,000	1550	384,000	1710
2	7.39	344,000	1530	396,000	1760	434,000	1930
2 1/8	8.35	384,000	1710	442,000	1970	488,000	2170
2 1/4	9.36	430,000	1910	494,000	2200	544,000	2420
2 3/8	10.4	478,000	2130	548,000	2440	604,000	2690
2 1/2	11.6	524,000	2330	604,000	2690	664,000	2950
2 5/8	12.8	576,000	2560	658,000	2930	728,000	3240
2 3/4	14.0	628,000	2790	736,000	3270	794,000	3530
2 7/8	15.3	682,000	3030	796,000	3540	864,000	3840
3	16.6	740,000	3290	856,000	3810	936,000	4160
3 1/8	18.0	798,000	3550	920,000	4090	1,010,000	4490
3 1/4	19.5	858,000	3820	984,000	4380	1,086,000	4830
3 1/8	21.0	918,000	4080	1,074,000	4780	1,164,000	5180
3 1/2	22.7	982,000	4370	1,144,000	5090	1,242,000	5520
3 3/4	26.0	1,114,000	4960	1,290,000	5740	1,410,000	6270
4	29.6	1,254,000	5580	1,466,000	6520	1,586,000	7050

EEEEIPS & HIGHER GRADES - AVAILABLE ON SPECIAL ORDER.



Wire Rope

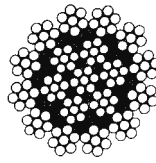

19 X 7
NON-ROTATING

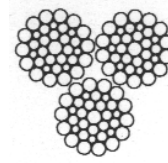

3 X 36 CLASS

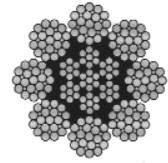

8 X 19 CLASS

ROTATION RESISTANT TYPES

SPIN RESISTANT NOMINAL STRENGTHS OF WIRE ROPE

ROTATION RESISTANT NOMINAL STRENGTHS OF WIRE ROPE

19 x 7 Classification/Bright (Uncoated) or
Drawn-Galvanized Wire Strand Core

Nominal Diameter	Nominal Strength	Approx. Mass
1/4	2.77	0.113
5/16	4.30	0.175
3/8	6.15	0.25
7/16	8.33	0.35
1/2	10.8	0.45
9/16	13.6	0.58
5/8	16.8	0.71
3/4	24.0	1.02
7/8	32.5	1.39
1	42.2	1.82
1 1/8	53.1	2.30
1 1/4	65.1	2.84

TORQUE BALANCED NOMINAL STRENGTHS OF WIRE ROPE

3 Strand Classification/Bright (Uncoated) or
Drawn-Galvanized Wire Strand Core

Size Inches	Construction	Mass Wt/Lb/Ft	Min Break Strength Lb.
1/2	3 x 41	.417	25,700
5/16	3 x 41	.517	32,500
3/8	3 x 41	.631	40,300
7/16	3 x 41	.903	57,800
1/2	3 x 46	1.27	83,200
1	3 x 46	1.64	100,000
1 1/8	3 x 46	2.07	124,000
1 1/4	3 x 46	2.60	158,000
1 3/8	3 x 46	3.10	188,000
1 1/2	3 x 46	3.69	222,000

8 x 19 Classification/Bright (Uncoated), or
Drawn-Galvanized, IWRC (EIPS)

Nominal Diam. (in.)	Nominal Strength	Approx. Mass
1/2	11.6	.47
5/16	14.7	.60
3/8	18.1	.73
3/4	25.9	1.06
7/8	35.0	1.44
1	45.5	1.88

Meets or exceeds API-9A and federal specification RR-W-410 (latest revision) where applicable.

*To convert to Kilonewtons (kN), multiply tons (nominal breaking strength) by 8.896; 1 lb = 4.448 newtons (N).
For Hot-Dipped Galvanized Strengths, Deduct 10%.

THE GIVEN STRENGTHS FOR 8 X 19 SPIN RESISTANT, 19 X 7 ROTATION RESISTANT WIRE ROPE ARE
APPLICABLE ONLY WHEN A TEST IS CONDUCTED ON A NEW ROPE FIXED AT BOTH ENDS

When the rope is in use and one end is free to rotate, the nominal strength is reduced.



Wire Rope

COMPACTED STRAND

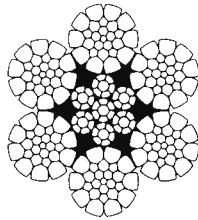

6 x 26

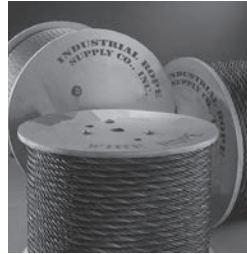

WIRE ROPE

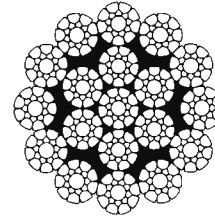

19 X 19 & 19 X 7
Rotation Resistant

- Mining, industrial, construction, logging, and oilfield applications.
- Stability, strength, fatigue resistance, and abrasion resistance.
- All popular sizes.
- Longer service life.

Extra value means different things in different applications. **CompactGold™** is one of the most versatile new rope constructions to emerge from our new products effort. In applications where increased strength, stability, and abrasion resistance are beneficial, **CompactGold™** is a natural and can result in longer service life. From boom hoist ropes and drag ropes in mining applications, to sawmill carriage ropes and mainline ropes in logging, its versatility and extra value make a difference.

- As single-part hoist lines and wherever spooling problems, drum crushing, bird caging, block twisting and fast line speeds are likely to be encountered.
- At the design and specification stage, ideal when machinery space and weight savings are important.
- Greater fatigue resistance cuts rope expense in applications where fatigue is the primary cause for removal.
- Ideally suited to rugged applications.

This rotation resistant, higher strength rope provides extra value in both original equipment designs and replacement applications. **CompactGold™** provides higher strength in a smaller diameter, and resistance to drum crushing.

Nominal Diameter In.	6 X 26 Compacted Strand Bright		**19 X 7 and 19 X 19 Compacted Strand Rotation Resistant		
	Nominal Strength Tons	Approx. Mass	Construction	Nominal Strength Tons	Approx. Mass
1/4	3.91	.131	19 x 19	3.74	.127
5/16	6.06	.218	19 x 19	5.8	.212
3/8	8.80	.32	19 x 19	8.3	.31
7/16	11.9	.41	19 x 19	11.2	.40
1/2	15.3	.55	19 x 19	14.6	.54
5/8	19.2	.70	19 x 19	18.5	.69
3/4	22.7	.86	19 x 19	22.7	.85
7/8	32.4	1.25	19 x 19	32.4	1.25
1	43.8	1.67	19 x 19	43.8	1.68
1 1/8	56.9	2.18	19 x 19	56.9	2.17
1 1/4	71.5	2.71	19 x 19	71.5	2.75
1 3/8	87.9	3.45	19 x 19	87.9	3.45
1 1/2	106	4.25	19 x 19	106	4.33
1 3/4	125	5.01	19 x 19	125	5.11

ALSO AVAILABLE
Compacted Strand
Wire Ropes from Various
Manufacturer's Overseas.

All meet the requirements as specified in API 9A and federal specification RR-W-410 (latest revision) when applicable.

* Available in U.S.A. and import.

** The given strengths for 19 strand rotation resistant wire ropes are applicable only when a test is conducted on a new rope fixed at both ends. When the rope is in use and one end is free to rotate, the nominal strength is reduced.



Metric Crane Ropes

- * Available in inches and millimeters
- * Super Rotation Resistance
- * Can be used with in-line Swivels
- * Up to 2160 Grade Tensile
- * Drawn Galvanized available, for added corrosion protection, at same strength.
- * Regular or Compacted Strand.

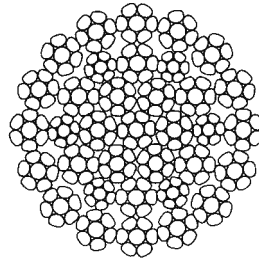

Compacted Strand
35 X 7 Class

2160 GRADE

Nominal Diameter mm-1/+4%	Mass (lbs/ft)	Estimated Break Strength (lbs)
10	0.312	31,580
12	0.450	30,570
13	0.538	36,460
14	0.622	42,260
15	0.712	49,000
16	0.800	54,400
17	0.907	61,370
18	1.011	70,140
19	1.136	78,230
20	1.297	87,450
21	1.431	96,660
22	1.556	105,210
23	1.699	114,650
24	1.848	123,950
25	2.009	134,430
1"	2.100	147,700
26	2.157	144,320
28	2.553	169,730
29	2.688	177,590
30	2.923	192,210
32	3.313	217,160
34	3.736	245,040
36	4.193	273,140

Estimated breaking strength shown. **Call for available breaking strength.**
ALL SPECIFICATIONS HEREIN ARE SUBJECT TO CHANGE WITHOUT NOTICE.

Aircraft Cables

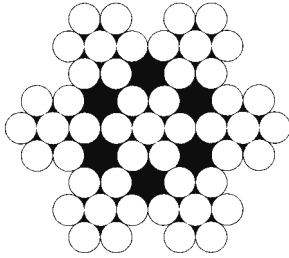
7 X 7
GALVANIZED

Diameter in Inches	Construction	Breaking Strength (lbs)	Approx. Weight per Foot (lbs)
1/16	7x7	480	.0075
3/32	7x7	920	.016
1/8	7x7	1,700	.028
1/8	7x19	2,000	.029
5/32	7x7	2,600	.043
5/32	7x19	2,800	.045
3/16	7x7	3,700	.062
3/16	7x19	4,200	.065
7/32	7x19	5,600	.086
1/4	7x7	6,100	.106
1/4	7x19	7,000	.11
5/16	7x19	9,800	.173
3/8	7x19	14,400	.243

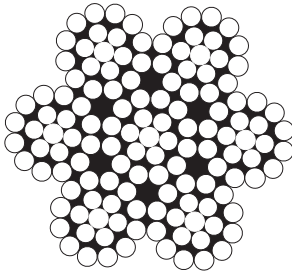
STAINLESS STEEL (T304)

7 X 19

Diameter in Inches	Construction	Breaking Strength (lbs)	Approx. Weight per Foot (lbs)
1/16	7x7	480	.007
3/32	7x7	920	.016
1/8	7x7	1,760	.028
1/8	7x19	1,760	.029
3/16	7x7	3,700	.062
3/16	7x19	3,700	.065
1/4	7x19	6,400	.11
5/16	7x19	9,000	.173
3/8	7x19	12,000	.243

STAINLESS STEEL (T316)

Diameter in Inches	Construction	Breaking Strength (lbs)	Approx. Weight per Foot (lbs)
1/16	7x7	480	.007
1/8	7x19	1670	.029
3/16	7x19	3565	.065
1/4	7x19	5875	.11
5/16	7x19	8825	.173
3/8	7x19	11,760	.243

All meet or exceed federal specification RR-W-410 (latest revision).
 Uncoated cable meets dimensional and strength requirements of MIL-W-83420E.



GALVANIZED STEEL STRAND* - 1 X 7
 ASTM A475, CLASS A COATING,
 LEFT REGULAR LAY, EXTRA HIGH STRENGTH**

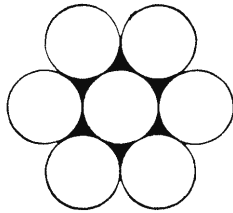

1x7 Strand

Diameter Inches	Nominal Breaking Strength (Tons)	Approx. Weight Per Foot (lbs)
$\frac{3}{16}$	1.99	.073
$\frac{1}{4}$	3.32	.12
$\frac{5}{16}$	5.6	.225
$\frac{3}{8}$	7.7	.273
$\frac{7}{16}$	10.7	.399
$\frac{1}{2}$	13.45	.517
$\frac{9}{16}$	19.5	.637
$\frac{5}{8}$	21.2	.796

MADE IN U.S.A.

**OTHER GRADES ALSO AVAILABLE

GALVANIZED STEEL STRAND* - 1 X 19
 ASTM A475, CLASS A COATING,
 LEFT REGULAR LAY, EXTRA HIGH STRENGTH

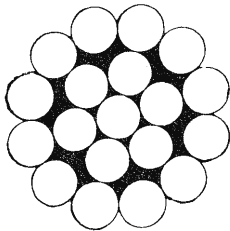

1x19 Strand

Diameter Inches	Nominal Breaking Strength (Tons)	Approx. Weight Per Foot (lbs)
$\frac{3}{4}$	29.15	1.16
$\frac{7}{8}$	39.85	1.58
1	52.25	2.07

MADE IN U.S.A.

*MEETS OR EXCEEDS FEDERAL SPECIFICATIONS RR-W-410 (latest revision)

ASTM A586 & A603 ALSO AVAILABLE
 BRIDGE AND STRAND SOCKETS ALSO AVAILABLE
 STAINLESS STEEL STRAND ALSO AVAILABLE



GALVANIZED, CLEAR VINYL COATED - 7 X 7 & 7 X 19

Diameter (In)	Coated To (In)	Weight per foot (lbs)	Breaking Strength (lbs)	Construction
1/16	3/32	.0093	480	7x7
1/16	1/8	.012	480	7x7
3/32	1/8	.018	920	7x7
3/32	3/16	.026	920	7x7
1/8	3/16	.035	1,700	7x7
3/32	1/8	.019	1,000	7x19
1/8	3/16	.036	2,000	7x19
3/16	1/4	.077	4,200	7X19
3/16	5/16	.08	4,200	7X19
1/4	5/16	.12	7,000	7X19
5/16	3/8	.20	9,800	7X19
3/8	7/16	.27	14,400	7X19

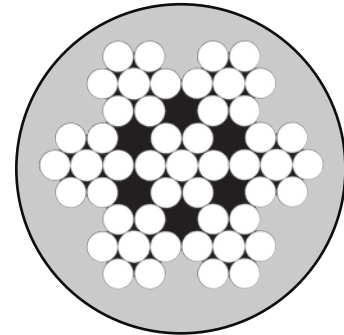

7 X 7

STAINLESS STEEL, CLEAR VINYL COATED - 7 X 19

Diameter (In)	Coated To (In)	Weight per foot (lbs)	Breaking Strength (lbs)	Construction
1/8	3/16	.036	1,760	7x19
3/16	1/4	.077	3,700	7x19
1/4	5/16	.128	6,400	7x19
5/16	3/8	.20	9,000	7x19
3/8	7/16	.27	12,000	7x19

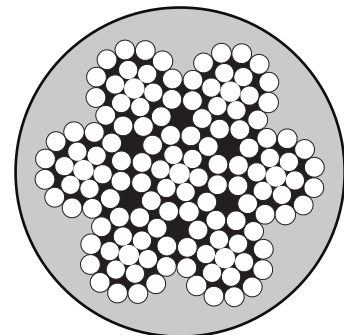

7 X 19

MEETS OR EXCEEDS FEDERAL SPECIFICATION RR-W-410 (latest revision)

Wire Rope Fittings





Forged Wire Rope Clips

G-450



2

- Each base has a Product Identification Code (PIC) for material traceability, the name CROSBY or CG, and a size forged into it.
- Based on the catalog breaking strength of wire rope, Crosby wire rope clips have an efficiency rating of 80% for 1/8" - 7/8" sizes, and 90% for sizes 1" through 3-1/2".
- Entire Clip-Galvanized to resist corrosive and rusting action.
- Sizes 1/8" through 2-1/2" and 3" have forged bases.
- All Clips are individually bagged or tagged with proper application instructions and warning information.
- Clip sizes up through 1-1/2" have rolled threads.
- Meets or exceeds all requirements of ASME B30.26 including identification, ductility, design factor, proof load and temperature requirements. Importantly, these wire rope clips meet other critical performance requirements including fatigue life, impact properties and material traceability, not addressed by ASME B30.26.
- Look for the Red-U-Bolt®, your assurance of Genuine Crosby Clips.

Crosby Clips, all sizes 1/4" and larger, meet the performance requirements of Federal Specification FF-C-450 TYPE 1 CLASS 1, except for those provisions required of the contractor.

G-450 Crosby® Clips

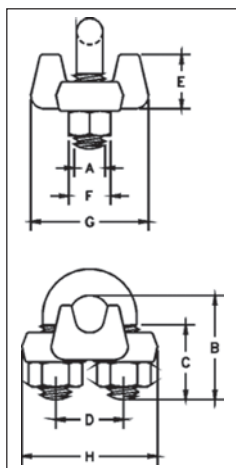

Rope Size		G-450 Stock No.	Std. Package Qty.	Weight Per 100 (lbs.)	Dimensions (in.)							
(in.)	(mm)				A	B	C	D	E	F	G	H
1/8	3-4*	1010015	100	6	.22	.72	.44	.47	.37	.38	.81	.99
3/16*	5*	1010033	100	10	.25	.97	.56	.59	.50	.44	.94	1.18
1/4	6-7	1010051	100	19	.31	1.03	.50	.75	.66	.56	1.19	1.43
5/16	8	1010079	100	28	.38	1.38	.75	.88	.73	.69	1.31	1.66
3/8	9-10	1010097	100	48	.44	1.50	.75	1.00	.91	.75	1.63	1.94
7/16	11	1010113	50	78	.50	1.88	1.00	1.19	1.13	.88	1.91	2.28
1/2	12-13	1010131	50	80	.50	1.88	1.00	1.19	1.13	.88	1.91	2.28
9/16	14-15	1010159	50	109	.56	2.25	1.25	1.31	1.34	.94	2.06	2.50
5/8	16	1010177	50	110	.56	2.25	1.25	1.31	1.34	.94	2.06	2.50
3/4	18-20	1010195	25	142	.62	2.75	1.44	1.50	1.39	1.06	2.25	2.84
7/8	22	1010211	25	212	.75	3.12	1.62	1.75	1.58	1.25	2.44	3.16
1	24-26	1010239	10	252	.75	3.50	1.81	1.88	1.77	1.25	2.63	3.47
1-1/8	28-30	1010257	10	283	.75	3.88	2.00	2.00	1.91	1.25	2.81	3.59
1-1/4	32-34	1010275	10	438	.88	4.44	2.22	2.34	2.17	1.44	3.13	4.13
1-3/8	36	1010293	10	442	.88	4.44	2.22	2.34	2.31	1.44	3.13	4.19
1-1/2	38	1010319	10	544	.88	4.94	2.38	2.59	2.44	1.44	3.41	4.44
1-5/8	41-42	1010337	Bulk	704	1.00	5.31	2.62	2.75	2.66	1.63	3.63	4.75
1-3/4	44-46	1010355	Bulk	934	1.13	5.75	2.75	3.06	2.92	1.81	3.81	5.24
2	48-52	1010373	Bulk	1300	1.25	6.44	3.00	3.38	3.03	2.00	4.44	5.88
2-1/4	56-58	1010391	Bulk	1600	1.25	7.13	3.19	3.88	3.19	2.00	4.56	6.38
2-1/2	62-65	1010417	Bulk	1900	1.25	7.69	3.44	4.13	3.69	2.00	4.69	6.63
** 2-3/4	** 68-72	1010435	Bulk	2300	1.25	8.31	3.56	4.38	4.88	2.00	5.00	6.88
3	75-78	1010453	Bulk	3100	1.50	9.19	3.88	4.75	4.44	2.38	5.31	7.61
** 3-1/2	** 85-90	1010426	Bulk	4000	1.50	10.75	4.50	5.50	6.00	2.38	6.19	8.38

* Electro-plated U-Bolt and Nuts. ** 2-3/4" and 3-1/2" base is made of cast steel.

- Each base has a Product Identification Code (PIC) for material traceability, the name CROSBY or "CG", and a size forged into it.
- Entire clip is made from 316 Stainless Steel to resist corrosive and rusting action.
- All components are Electro-Polished.
- All Clips are individually bagged or tagged with proper application instructions and warning information.

SS-450



SS-450 Stainless Steel Wire Rope Clips

Rope Size		SS-450 Stock No.	Std. Package Qty.	Weight Per 100 (lbs.)	Dimensions (in.)							
(in.)	(mm)				A	B	C	D	E	F	G	H
1/8	3-4	1011250	Bulk	6	.22	.72	.44	.47	.41	.38	.81	.94
3/16	5	1011261	Bulk	10	.25	.97	.56	.59	.50	.44	.94	1.16
1/4	6-7	1011272	Bulk	20	.31	1.03	.50	.75	.66	.56	1.19	1.44
3/8	9-10	1011283	Bulk	47	.44	1.50	.75	1.00	.91	.75	1.63	1.94
1/2	12-13	1011305	Bulk	77	.50	1.88	1.00	1.19	1.13	.88	1.91	2.28
5/8	16	1011327	Bulk	106	.56	2.38	1.25	1.31	1.34	.94	2.06	2.50



Fist Grip® Wire Rope Clips

NEW STYLE FIST GRIP® CLIPS 3/16" - 5/8"



Fist Grip® wire clips meet or exceed the performance requirements of Federal Specification FF-C-450 Type III, Class 1, except for those provisions required of the contractor.

- Entire clip is Galvanized to resist corrosive and rusting action.
- Based on the catalog breaking strength of wire rope, Crosby wire rope clips have an efficiency rating of 80% for 3/16" - 7/8" sizes, and 90% for sizes 1" through 1-1/2".
- Bolts are an integral part of the saddle. Nuts can be installed in such a way as to enable the operator to swing the wrench in a full arc for fast installation.
- All sizes have forged steel saddles.
- All Clips are individually bagged or tagged with proper application instructions and warning information.
- Meets or exceeds all requirements of ASME B30.26 including identification, ductility, design factor, proof load and temperature requirements. Importantly, these wire rope clips meet other critical performance requirements including fatigue life, impact properties and material traceability, not addressed by ASME B30.26.
- Assembled with standard heavy hex nuts.

FIST GRIP® CLIPS 3/4" - 1-1/2"



2

3/16" - 5/8"

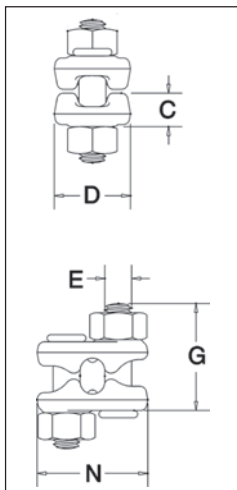

3/4" - 1-1/2"

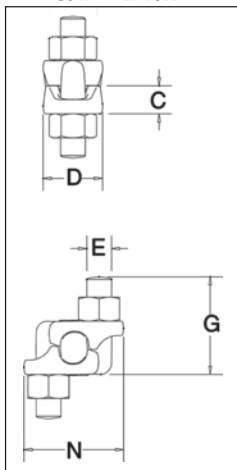

G-429 Fist Grip® Clips

Rope Size		G-429 Stock No.	Std. Package Qty.	Weight Per 100 (lbs.)	Dimensions (in.)				
(in.)*	(mm)				C	D	E	G	N
3/16 - 1/4	5-7	1010471	100	23	.40	.94	.38	1.41	1.44
5/16	8	1010499	100	28	.47	1.06	.38	1.50	1.54
3/8	10	1010514	50	40	.51	1.06	.44	1.84	1.78
7/16 - 1/2	11-13	1010532	50	62	.59	1.25	.50	2.21	2.15
9/16 - 5/8	14-16	1010550	50	103	.72	1.50	.63	2.72	2.57
3/4	18-20	1010578	25	175	.86	1.81	.75	2.94	2.67
7/8	22	1010596	25	225	.97	2.12	.75	3.31	2.86
1	24-26	1010612	10	300	1.13	2.25	.75	3.72	3.06
1-1/8	28-30	1010630	10	400	1.28	2.38	.88	4.22	3.44
1-1/4	32-34	1010658	10	400	1.34	2.50	.88	4.25	3.56
1-3/8 - 1-1/2	36-40	1010676	Bulk	700	1.56	3.00	1.00	5.56	4.12

* Sizes through 5/8" incorporate New Style Design.



S-421T Wedge Sockets



Scan this QR code with your smart device to view our Terminator video.

S-421T



Wedge sockets meet the performance requirements of Federal Specification RR-S-550E, Type C, except those provisions required of the contractor.

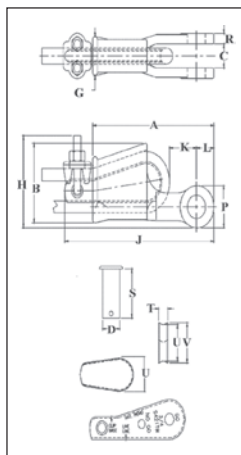

- Wedge socket terminations have an efficiency rating of 80% based on the catalog strength of XXIP wire rope.
- Meets or exceeds all requirements of ASME B30.26 including identification, ductility, design factor, proof load and temperature requirements. Importantly, these sockets meet other critical performance requirements including fatigue life, impact properties and material traceability, not addressed by ASME B30.26.
- Type Approval and certification in accordance with ABS 2007 Steel Vessel Rules.1-1-17.7, and ABS Guide for Certification of Cranes.
- Basket is cast steel and individually magnetic particle inspected.
- Pin diameter and jaw opening allows wedge and socket to be used in conjunction with closed swage and spelter sockets.
- Secures the tail or "dead end" of the wire rope to the wedge, thus eliminates loss or "Punch out" of the wedge.
- Eliminates the need for an extra piece of rope, and is easily installed.
- The TERMINATOR™ wedge eliminates the potential breaking off of the tail due to fatigue.
- The tail, which is secured by the base of the clip and the wedge, is left undeformed and available for reuse.
- Incorporates Crosby's patented QUIC-CHECK® "Go" and "No-Go" feature cast into the wedge. The proper size rope is determined when the following criteria are met:
 - 1) The wire rope should pass thru the "Go" hole in the wedge.
 - 2) The wire rope should NOT pass thru the "No-Go" hole in the wedge.
- Utilizes standard Crosby Red-U-Bolt® wire rope clip.
- The 3/8" thru 1-1/8" standard S-421 wedge socket can be retrofitted with the new style TERMINATOR™ wedge.
- Available with Bolt, Nut, and Cotter Pin.
- U.S. patent 5,553,360, Canada patent 2,217,004 and foreign equivalents.
- Meets the performance requirements of EN 13411-6: 2003.

S-421T Wedge Sockets

Assembly includes Socket, Wedge, Pin and Wire Rope Clip

Wire Rope Dia.		S-421T Stock No.	API 2C S-421T Stock No.	Weight Each (lbs.)	S-421TW Stock No. Wedge Only	API 2C S-421TW Stock No. Wedge Only	Wedge Only Weight Each (lbs.)	Optional G-4082 Bolt, Nut & Cotter	
(in.)	(mm)							G-4082 Stock No.	Weight Each (lbs.)
3/8	9-10	1035000	1035005	3.18	1035555	1092230	.50	1092227	.38
1/2	11-13	1035009	1035014	6.15	1035564	1092248	1.05	1092236	.69
5/8	14-16	1035018	1035023	9.70	1035573	1092257	1.79	1092254	1.15
3/4	18-19	1035027	1035032	14.50	1035582	1092293	2.60	1092281	1.91
7/8	20-22	1035036	1035041	21.50	1035591	1092319	4.00	1092307	3.23
1	24-26	1035045	1035050	30.75	1035600	1092337	5.37	1092325	5.40
1-1/8	28	1035054	1035059	45.30	1035609	1092364	7.30	1092343	7.50
1-1/4	30-32	1035063	1035068	64.90	1035618	1092375	10.60	1092372	10.34

Wire Rope Dia.		S-421T Stock No.	API 2C S-421T Stock No.	Dimensions (in.)														
(in.)	(mm)			A	B	C +/- .09	D	G	H	J*	K*	L	P	R	S	T	U	V
3/8	9-10	1035000	1035005	5.69	2.72	.81	.81	1.38	3.06	7.80	1.88	.88	1.56	.44	2.13	.44	1.25	1.38
1/2	11-13	1035009	1035014	6.88	3.47	1.00	1.00	1.62	3.76	8.91	1.26	1.06	1.94	.50	2.56	.53	1.75	1.88
5/8	14-16	1035018	1035023	8.25	4.30	1.25	1.19	2.12	4.47	10.75	1.99	1.22	2.25	.56	3.25	.69	2.00	2.19
3/4	18-19	1035027	1035032	9.88	5.12	1.50	1.38	2.44	5.28	12.36	2.41	1.40	2.63	.66	3.63	.78	2.34	2.56
7/8	20-22	1035036	1035041	11.25	5.85	1.75	1.63	2.69	6.16	14.37	2.48	1.67	3.13	.75	4.31	.88	2.69	2.94
1	24-26	1035045	1035050	12.81	6.32	2.00	2.00	2.94	6.96	16.29	3.04	2.00	3.75	.88	4.70	1.03	2.88	3.28
1-1/8	28	1035054	1035059	14.38	6.92	2.25	2.25	3.31	7.62	18.34	2.56	2.25	4.25	1.00	5.44	1.10	3.25	3.56
1-1/4	30-32	1035063	1035068	16.34	8.73	2.62	2.50	3.56	9.39	20.48	2.94	2.34	4.50	1.06	6.13	1.19	4.62	4.94

* Nominal NOTE: For intermediate wire rope sizes, use next larger size socket.

The S-423T Super TERMINATOR™ wedge is designed to be assembled only into the Crosby S-421T TERMINATOR™ socket body.

IMPORTANT: The S-423TW for sizes 5/8" through 1-1/8" (14mm through 28mm) will fit respective size standard Crosby S-421T basket. The 1-1/4" (30-32mm) S-423TW will only fit the Crosby S-421T 1-1/4" basket marked with "TERMINATOR™"



US-422T Utility Wedge Sockets



US-422T



Most sizes now incorporate the "TERMINATOR™" design and may vary in shape from above product shown.

- Basket is cast steel and individually magnetic particle inspected.
- Wedge socket terminations have an efficiency rating of 80% based on the catalog strength of XXIP wire rope.
- Wedges are color coded for easy identification.
 - Blue - largest wire line size for socket.
 - Black - mid size wire line for socket.
 - 7/16" on US4
 - 9/16" on US5
 - Orange - smallest wire line size for socket.
- Cast into each socket is the name "McKissick", "Crosby" or "CG", its model number and its wire line range.
- By simply changing out the wedge, each socket can be utilized for various wire line sizes (Ensure correct wedge is used for wire rope size).
- Cast into each wedge is the model number of the socket and the wire line size for which the wedge is to be used.
- Load pin is forged and headed on one end.
- US-422T wedge sockets contain a hammer pad (lip) to assist in proper securement of termination.
- Meets or exceeds all requirements of ASME B30.26 including identification, ductility, design factor, proof load and temperature requirements. Importantly, these sockets meet other critical performance requirements including fatigue life, impact properties and material traceability, not addressed by ASME B30.26.
- UWO-422T Wedges are to be used only with the US-422T Wedge Socket Assemblies.

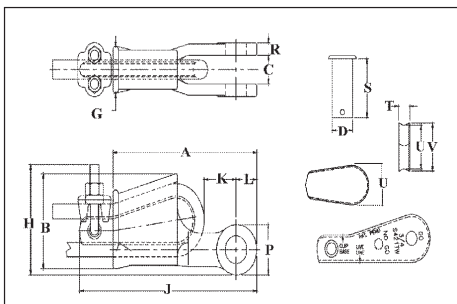

Scan this QR code with your smart device to view our Wedge and Button Sockets video.

US-422T Utility Wedge Sockets

Model No.	Wire Rope Size		US-422T Stock No.	API 2C US-422T Stock No.	Weight Each (lbs.)	Wedge Only Stock No.	Weight Each (lbs.)	Dimensions (in.)														
	(in.)	(mm)						A	B	C +/- .09	D	G	H	J	K	L	P	R	S	T	U	V
US4T	3/8	10	1044300	1044305	4.6	1047310	.6	6.81	3.55	1.00	1.00	1.63	2.81	8.43	1.38	1.06	1.94	.50	2.53	.44	1.91	2.14
US4T	7/16	11	1044309	1044314	4.6	1047301	.6	6.81	3.55	1.00	1.00	1.63	2.81	8.73	1.08	1.06	1.94	.50	2.53	.53	1.76	1.88
US4T	1/2	13	1044318	1044323	4.6	1047329	.6	6.81	3.55	1.00	1.00	1.63	2.81	8.73	1.02	1.06	1.94	.50	2.53	.53	1.76	1.88
US5T	1/2	13	1044327	1044332	8.5	1047338	1.0	9.19	4.23	1.41	1.25	2.13	3.31	11.19	1.84	1.50	3.00	.63	3.25	.75	1.92	2.16
US5T	9/16	14	1044336	1044341	8.5	1047347	1.0	9.19	4.23	1.41	1.25	2.13	3.31	11.47	2.40	1.50	3.00	.63	3.25	.69	2.00	2.18
US5T	5/8	16	1044345	1044350	8.5	1047356	1.0	9.19	4.23	1.41	1.25	2.13	3.31	11.47	2.34	1.50	3.00	.63	3.25	.69	2.00	2.18
US6T	5/8	16	1044354	1044359	9.4	1047365	1.4	9.45	4.70	1.50	1.25	2.24	3.63	11.91	2.48	1.50	3.00	.56	3.25	.88	2.38	2.75
US6T	3/4	19	1044363	1044368	9.4	1047374	1.4	9.45	4.70	1.50	1.25	2.24	3.63	11.81	2.03	1.50	3.00	.56	3.25	.88	2.13	2.63
US8AT	5/8	16	1044372	1044377	19.8	1047383	4.3	10.59	5.68	1.81	1.63	2.38	5.53	13.19	1.91	1.53	2.88	.75	4.13	.69	3.26	3.50
US8AT	3/4	19	1044381	1044386	20.4	1047392	4.8	10.59	5.68	1.81	1.63	2.38	5.84	13.54	2.38	1.53	2.88	.75	4.13	.78	3.12	3.38
US7*	7/8	22	1038580	—	16.5	1046674	2.6	11.26	5.11	1.31	1.25	2.69	—	—	2.56	1.63	3.26	.66	3.25	1.06	2.12	2.56
US7*	1	25	1038589	—	16.5	1046683	2.6	11.26	5.11	1.31	1.25	2.69	—	—	2.56	1.63	3.26	.66	3.25	1.06	1.88	2.38
US8T	7/8	22	1044404	1044409	31.5	1047425	7.6	12.77	6.96	1.81	1.63	3.06	7.20	16.02	2.87	1.65	3.12	.75	4.13	.88	3.88	4.18
US8T	1	25	1044417	1044422	32.5	1047431	8.6	12.77	6.96	1.81	1.63	3.06	7.31	16.41	2.32	1.65	3.12	.75	4.13	1.03	3.76	4.06
US10T	1-1/8	28	1044426	1044431	55.4	1047440	12.5	15.94	8.62	1.81	1.63	3.57	9.15	19.72	3.26	2.19	4.38	.75	4.13	1.09	4.76	5.06
US10T	1-1/4	32	1044435	1044440	58.0	1047459	15.0	15.94	8.62	1.81	1.63	3.57	9.39	20.22	2.83	2.19	4.38	.75	4.13	1.19	4.62	4.94
US11T	1-1/8	28	1044444	1044449	60.6	1047468	12.5	16.34	8.73	2.62	2.50	3.56	9.15	19.97	3.37	2.34	4.50	1.06	6.13	1.09	4.76	5.06
US11T	1-1/4	32	1044453	1044458	64.9	1047477	15.0	16.34	8.73	2.62	2.50	3.56	9.39	20.48	2.94	2.34	4.50	1.06	6.13	1.19	4.62	4.94

* Non-"TERMINATOR™" Style



S-423T Super Terminator™

S-423T



Wedge sockets meet the performance requirements of Federal Specification RR-S-550E, Type C, except those provisions required of the contractor. Meets the performance requirements of EN13411-6:2003.

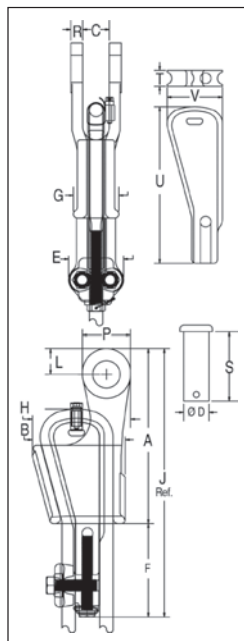

- The 423T wedge socket terminations have a minimum efficiency rating on most high performance, high strength, compacted strand, rotation resistant wire ropes of 80% based on the catalog breaking strength of the various ropes.**
- Design eliminates the difficulty of properly seating the wedge with high performance wire rope into a wedge socket termination.
- Proper application of the Super TERMINATOR™ eliminates the “first load” requirement of conventional wedge socket terminations.
- S-423TW Wedge Kit can be retrofitted onto existing Crosby S-421T TERMINATOR™ wedge sockets.
- Wedge and accessories provided with a zinc finish.
- Meets the performance requirements of EN13411-6:2003.
- Meets or exceeds all requirements of ASME B30.26 including identification, ductility, design factor, proof load and temperature requirements. Importantly, these sockets meet other critical performance requirements including fatigue life, impact properties and material traceability, not addressed by ASME B30.26.
- Basket is cast steel and individually magnetic particle inspected.
- Pin diameter and jaw opening allows wedge and socket to be used in conjunction with closed swage and spelter sockets.
- Secures the tail or “dead end” of the wire rope to the wedge, thus eliminates loss or “punch out” of the wedge.
- Eliminates the need for an extra piece of rope, and is easily installed.
- The TERMINATOR™ wedge eliminates the potential breaking off of the tail due to fatigue.
- The tail, which is secured by the base of the clip and the tensioner device, is left undeformed and available for reuse.
- Available with Bolt, Nut, and Cotter Pin.
- US Patent 8,375,527 B1.

**** NOTICE:** Due to the unique construction of various ropes, Crosby cannot make a broad general statement that all current and future design of ropes, when properly assembled with the Super TERMINATOR™, will achieve a minimum 80% termination efficiency. Contact wire rope manufacturer or Crosby Engineering (918-834-4611) to determine efficiency rating for a specific rope.

S-423T Wedge Sockets Assembly includes Socket, Wedge, Pin, Wire Rope Clip, Tensioner, Bolts and Secondary Retention Wire.

Wire Rope Dia.	S-423T Assembly with Round Pin and Cotter Pin				S-423TB Assembly with Bolt, Nut and Cotter Pin				S-423TW** Wedge Kit			
	S-423T Stock No.	API 2C S-423T Stock No.	S-423T Weight Each		S-423TB Stock No.	API 2C S-423TB Stock No.	S-423TB Weight Each		S-423TW Stock No.	S423TW Weight Each		
(in.) (mm)			(lbs.)	(kg)			(lbs.)	(kg)		(lbs.)	(kg)	
5/8	14-16	1035123	1035128	12.7	5.8	1035218	1035223	13.1	5.9	1034018	5.2	2.4
3/4	18-19	1035132	1035137	19.4	8.8	1035227	1035232	19.1	8.7	1034027	7.2	3.3
7/8	20-22	1035141	1035146	28.8	13.1	1035236	1035241	27.8	12.6	1034036	10.3	4.7
1	24-26	1035150	1035155	39.2	17.8	1035245	1035250	37.3	16.9	1034045	11.9	5.4
1-1/8	28	1035169	1035174	57.1	25.9	1035254	1035259	57.9	25.9	1034054	19.9	9.0
1-1/4	30-32	1035178	1035183	88.6	40.2	1035272	1035277	88.1	39.9	1034063	33.8	15.3

** Kit contains Wedge, Wire Rope Clip and Bolts, Tensioner, Tensioner Bolt and Secondary Retention Wire.

Wire Rope Dia.	S-423T Stock No.	Dimensions (in.)																
		A	B	C	D	E	F	G	H	J*	L	P	R	S	T	U	V	
5/8	14-16	1035123	8.25	4.50	1.25	1.19	3.00	4.06	2.13	4.61	12.31	1.22	2.25	.56	3.25	.75	6.88	2.60
3/4	18-19	1035132	9.88	5.20	1.50	1.38	3.25	4.81	2.44	5.37	14.69	1.40	2.62	.66	3.63	.88	7.65	3.02
7/8	20-22	1035141	11.25	5.88	1.75	1.63	3.81	5.73	2.69	6.16	16.98	1.67	3.13	.75	4.31	1.00	9.47	3.47
1	24-26	1035150	12.81	6.56	2.00	2.00	3.81	5.73	2.94	7.05	18.54	2.01	3.75	.88	4.70	1.13	10.41	3.82
1-1/8	28	1035169	14.38	6.94	2.25	2.25	4.00	6.85	3.38	7.81	21.23	2.26	4.25	1.00	5.44	1.25	11.83	4.22
1-1/4	30-32	1035178	16.34	8.63	2.62	2.50	4.50	7.76	3.57	9.38	24.10	2.34	4.50	1.06	6.62	1.38	13.87	5.82

* Nominal

NOTE: For intermediate wire rope sizes, use next larger size socket.

The S-423T Super TERMINATOR™ wedge is designed to be assembled only into the Crosby S-421T TERMINATOR™ socket body. IMPORTANT: The S-423TW for sizes 5/8” through 1-1/8” (14mm through 28mm) will fit respective size standard Crosby S-421T basket. The 1-1/4” (30-32mm) S-423TW will only fit the Crosby S-421T 1-1/4” basket marked with “ TERMINATOR™”.



Scan this QR code with your smart device to view our Super Terminator video.



Crosby® Round Pin Shackles

Load Rated®

ROUND PIN ANCHOR SHACKLES



G-213 / S-213

G-213 Round pin anchor shackles meet the performance requirements of Federal Specification RR-C-271F Type IVA, Grade A, Class 1, except for those provisions required of the contractor.

Fatigue Rated®

QT
QUENCHED & TEMPERED

QUIC-CHECK®

MAXTOUGH®

- Capacities 1/2 through 35 metric tons.
- Forged - Quenched and Tempered, with alloy pins.
- Working Load Limit permanently shown on every shackle.
- Hot Dip galvanized or Self Colored.
- Fatigue rated.
- Shackles 25t and larger are RFID EQUIPPED.
- Shackles can be furnished proof tested with certificates to designated standards, such as ABS, DNV, Lloyds, or other certification. Charges for proof testing and certification available when requested at the time of order.
- Shackles are Quenched and Tempered and can meet DNV impact requirements of 42 joules (31 ft-lbs.) at -20 degree C (-4 degree F).
- Look for the Red Pin® . . . the mark of genuine Crosby quality.



ROUND PIN CHAIN SHACKLES



G-215 / S-215

G-215 Round pin chain shackles meet the performance requirements of Federal Specification RR-C-271F Type IVB, Grade A, Class 1, except for those provisions required of the contractor.

G-213 / S-213 Round Pin Anchor Shackles

G-213 / S-213

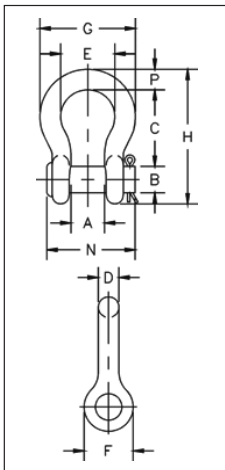

Nominal Size (in.)	Working Load Limit (t)*	Stock No.		Weight Each (lbs.)	Dimensions (in.)													Tolerance +/-	
		G-213	S-213		A	B	C	D	E	F	G	H	N	P	C	A			
1/4	1/2	1018017	1018026	.13	.47	.31	1.13	.25	.78	.61	1.28	1.84	1.34	.25	.06	.06			
5/16	3/4	1018035	1018044	.18	.53	.38	1.22	.31	.84	.75	1.47	2.09	1.59	.31	.06	.06			
3/8	1	1018053	1018062	.29	.66	.44	1.44	.38	1.03	.91	1.78	2.49	1.86	.38	.13	.06			
7/16	1-1/2	1018071	1018080	.38	.75	.50	1.69	.44	1.16	1.06	2.03	2.91	2.13	.44	.13	.06			
1/2	2	1018099	1018106	.71	.81	.63	1.88	.50	1.31	1.19	2.31	3.28	2.38	.50	.13	.06			
5/8	3-1/4	1018115	1018124	1.50	1.06	.75	2.38	.63	1.69	1.50	2.94	4.19	2.91	.69	.13	.06			
3/4	4-3/4	1018133	1018142	2.32	1.25	.88	2.81	.75	2.00	1.81	3.50	4.97	3.44	.81	.25	.06			
7/8	6-1/2	1018151	1018160	3.49	1.44	1.00	3.31	.88	2.28	2.09	4.03	5.83	3.81	.97	.25	.06			
1	8-1/2	1018179	1018188	5.00	1.69	1.13	3.75	1.00	2.69	2.38	4.69	6.56	4.53	1.06	.25	.06			
1-1/8	9-1/2	1018197	1018204	6.97	1.81	1.25	4.25	1.13	2.91	2.69	5.16	7.47	5.13	1.25	.25	.06			
1-1/4	12	1018213	1018222	9.75	2.03	1.38	4.69	1.29	3.25	3.00	5.75	8.25	5.50	1.38	.25	.06			
1-3/8	13-1/2	1018231	1018240	13.25	2.25	1.50	5.25	1.42	3.63	3.31	6.38	9.16	6.13	1.50	.25	.13			
1-1/2	17	1018259	1018268	17.25	2.38	1.63	5.75	1.54	3.88	3.63	6.88	10.00	6.50	1.62	.25	.13			
1-3/4	25	1018277	1018286	29.46	2.88	2.00	7.00	1.84	5.00	4.19	8.86	12.34	7.75	2.25	.25	.13			
2	35	1018295	1018302	45.75	3.25	2.25	7.75	2.08	5.75	4.81	9.97	13.68	8.75	2.40	.25	.13			

* NOTE: Maximum Proof Load is 2.0 times the Working Load Limit. Minimum Ultimate Strength is 6 times the Working Load Limit. For Working Load Limit reduction due to side loading applications, see page 91.

G-215 / S-215 Round Pin Chain Shackles

G-215 / S-215

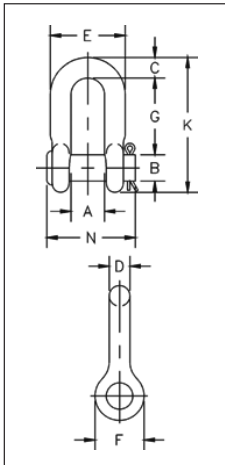

Nominal Size (in.)	Working Load Limit (t)*	Stock No.		Weight Each (lbs.)	Dimensions (in.)													Tolerance +/-	
		G-215	S-215		A	B	C	D	E	F	G	K	N	G	A				
1/4	1/2	1018810	1018829	.10	.47	.31	.25	.25	.97	.62	.91	1.59	1.34	.06	.06				
5/16	3/4	1018838	1018847	.18	.53	.38	.31	.31	1.15	.75	1.07	1.91	1.63	.06	.06				
3/8	1	1018856	1018865	.25	.66	.44	.38	.38	1.42	.92	1.28	2.31	1.86	.13	.06				
7/16	1-1/2	1018874	1018883	.40	.75	.50	.44	.44	1.63	1.06	1.48	2.67	2.13	.13	.06				
1/2	2	1018892	1018909	.50	.81	.63	.50	.50	1.81	1.18	1.66	3.03	2.38	.13	.06				
5/8	3-1/4	1018918	1018927	1.21	1.06	.75	.63	.63	2.32	1.50	2.04	3.76	2.91	.13	.06				
3/4	4-3/4	1018936	1018945	2.00	1.25	.88	.81	.75	2.75	1.81	2.40	4.53	3.44	.25	.06				
7/8	6-1/2	1018954	1018963	3.28	1.44	1.00	.97	.88	3.20	2.10	2.86	5.33	3.81	.25	.06				
1	8-1/2	1018972	1018981	4.75	1.69	1.13	1.00	1.00	3.69	2.38	3.24	5.94	4.53	.25	.06				
1-1/8	9-1/2	1018990	1019007	6.30	1.81	1.25	1.25	1.13	4.07	2.68	3.61	6.78	5.13	.25	.06				
1-1/4	12	1019016	1019025	9.00	2.03	1.38	1.38	1.25	4.53	3.00	3.97	7.50	5.50	.25	.13				
1-3/8	13-1/2	1019034	1019043	12.00	2.25	1.50	1.50	1.38	5.01	3.31	4.43	8.28	6.13	.25	.13				
1-1/2	17	1019052	1019061	16.15	2.38	1.63	1.62	1.50	5.38	3.62	4.87	9.05	6.50	.25	.13				
1-3/4	25	1019070	1019089	29.96	2.88	2.00	2.12	1.75	6.38	4.19	5.82	10.97	7.75	.25	.13				
2	35	1019098	1019105	43.25	3.25	2.25	2.36	2.10	7.25	5.00	6.82	12.74	8.75	.25	.13				

* NOTE: Maximum Proof Load is 2.0 times the Working Load Limit. Minimum Ultimate Strength is 6 times the Working Load Limit. For Working Load Limit reduction due to side loading applications.



Crosby® Screw Pin Shackles

Load Rated®

Fatigue Rated®

QT
QUENCHED & TEMPERED

QUIC-CHECK®

MAXTOUGH®

TA
TYPE APPROVED

SCREW PIN ANCHOR SHACKLES



G-209 / S-209

G-209 Screw pin anchor shackles meet the performance requirements of Federal Specification RR-C-271F Type IVA, Grade A, Class 2, except for those provisions required of the contractor.

SCREW PIN CHAIN SHACKLES



G-210 / S-210

G-210 Screw pin chain shackles meet the performance requirements of Federal Specification RR-C-271F, Type IVB, Grade A, Class 2, except for those provisions required of the contractor.

- Capacities 1/3 thru 55 metric tons, grade 6.
- Forged - Quenched and Tempered, with alloy pins.
- Working Load Limit and grade "6" permanently shown on every shackle.
- Hot Dip galvanized or Self Colored.
- Fatigue rated.
- Shackles 25t and larger are **RFID EQUIPPED**.
- Shackles can be furnished proof tested with certificates to designated standards, such as ABS, DNV, Lloyds, or other certification. Charges for proof testing and certification available when requested at the time of order.
- Approved for use at -40 degree C (-40 degree F) to 204 degree C (400 degree F).
- 2t through 25t bow and screw pin are Certified to meet charpy impact testing of 42 joules (31 ft-lbs.) min. ave. at -20 degree C (-4 degree F).
- All shackles are Quenched and Tempered and can meet DNV impact requirements of 42 joules (31 ft. lbs.) at -20 degree C (-4 degree F).
- Meets or exceeds all requirements of ASME B30.26.
- Type Approval and certification in accordance with ABS 2006 Steel Vessel Rules 1-1-17.7, and ABS Guide for Certification of Cranes.
- Crosby 2t through 25t G209 anchor shackles are type approved to DNV Certification Notes 2.7-1 -Offshore Containers. These Crosby shackles are statistical proof and impact tested. The tests are conducted by Crosby and 3.1 test certification is available upon request.
- Look for the Red Pin® . . . the mark of genuine Crosby quality.

G-209 / S-209

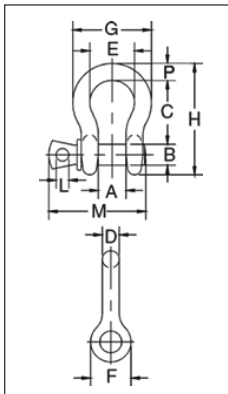

G-209 / S-209 Screw Pin Anchor Shackles

Nominal Size (in.)	Working Load Limit (t)*	Stock No.		Weight Each (lbs.)	Dimensions (in.)													Tolerance +/-	
		G-209	S-209		A	B	C	D	E	F	G	H	L	M	P	C	A		
3/16	1/3	1018357	-	.06	.38	.25	.88	.19	.60	.56	.98	1.47	.16	1.14	.19	.06	.06		
1/4	1/2	1018375	1018384	.10	.47	.31	1.13	.25	.78	.61	1.28	1.84	.19	1.43	.25	.06	.06		
5/16	3/4	1018393	1018400	.18	.53	.38	1.22	.31	.84	.75	1.47	2.09	.22	1.71	.31	.06	.06		
3/8	1	1018419	1018428	.31	.66	.44	1.44	.38	1.03	.91	1.78	2.49	.25	2.02	.38	.13	.06		
7/16	1-1/2	1018437	1018446	.38	.75	.50	1.69	.44	1.16	1.06	2.03	2.91	.31	2.37	.44	.13	.06		
1/2	2	1018455	1018464	.72	.81	.63	1.88	.50	1.31	1.19	2.31	3.28	.38	2.69	.50	.13	.06		
5/8	3-1/4	1018473	1018482	1.37	1.06	.75	2.38	.63	1.69	1.50	2.94	4.19	.44	3.34	.69	.13	.06		
3/4	4-3/4	1018491	1018500	2.35	1.25	.88	2.81	.75	2.00	1.81	3.50	4.97	.50	3.97	.81	.25	.06		
7/8	6-1/2	1018516	1018525	3.62	1.44	1.00	3.31	.88	2.28	2.09	4.03	5.83	.50	4.50	.97	.25	.06		
1	8-1/2	1018534	1018543	5.03	1.69	1.13	3.75	1.00	2.69	2.38	4.69	6.56	.56	5.13	1.06	.25	.06		
1-1/8	9-1/2	1018552	1018561	7.41	1.81	1.25	4.25	1.16	2.91	2.69	5.16	7.47	.63	5.71	1.25	.25	.06		
1-1/4	12	1018570	1018589	9.50	2.03	1.38	4.69	1.29	3.25	3.00	5.75	8.25	.69	6.25	1.38	.25	.06		
1-3/8	13-1/2	1018598	1018605	13.53	2.25	1.50	5.25	1.42	3.63	3.31	6.38	9.16	.75	6.83	1.50	.25	.13		
1-1/2	17	1018614	1018623	17.20	2.38	1.63	5.75	1.54	3.88	3.63	6.88	10.00	.81	7.33	1.62	.25	.13		
1-3/4	25	1018632	1018641	27.78	2.88	2.00	7.00	1.84	5.00	4.19	8.86	12.34	1.00	9.06	2.25	.25	.13		
2	35	1018650	1018669	45.00	3.25	2.25	7.75	2.08	5.75	4.81	9.97	13.68	1.22	10.35	2.40	.25	.13		
2-1/2	55	1018678	1018687	85.75	4.13	2.75	10.50	2.71	7.25	5.69	12.87	17.84	1.38	13.00	3.13	.25	.25		

G-210 / S-210 Screw Pin Chain Shackles

G-210 / S-210

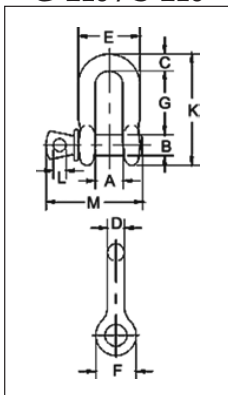

Nominal Size (in.)	Working Load Limit (t)*	Stock No.		Weight Each (lbs.)	Dimensions (in.)													Tolerance +/-	
		G-210	S-210		A	B	C	D	E	F	G	K	L	M	G	A			
1/4	1/2	1019150	1019169	.11	.47	.31	.25	.25	.97	.62	.97	1.59	.19	1.43	.06	.06			
5/16	3/4	1019178	1019187	.17	.53	.38	.31	.31	1.15	.75	1.07	1.91	.22	1.71	.06	.06			
3/8	1	1019196	1019203	.28	.66	.44	.38	.38	1.42	.92	1.28	2.31	.25	2.02	.13	.06			
7/16	1-1/2	1019212	1019221	.43	.75	.50	.44	.44	1.63	1.06	1.48	2.67	.31	2.37	.13	.06			
1/2	2	1019230	1019249	.59	.81	.63	.50	.50	1.81	1.18	1.66	3.03	.38	2.69	.13	.06			
5/8	3-1/4	1019258	1019267	1.25	1.06	.75	.63	.63	2.32	1.50	2.04	3.76	.44	3.34	.13	.06			
3/4	4-3/4	1019276	1019285	2.63	1.25	.88	.81	.75	2.75	1.81	2.40	4.53	.50	3.97	.25	.06			
7/8	6-1/2	1019294	1019301	3.16	1.44	1.00	.97	.88	3.20	2.10	2.86	5.33	.50	4.50	.25	.06			
1	8-1/2	1019310	1019329	4.75	1.69	1.13	1.00	1.00	3.69	2.38	3.24	5.94	.56	5.13	.25	.06			
1-1/8	9-1/2	1019338	1019347	6.75	1.81	1.25	1.25	1.13	4.07	2.69	3.61	6.78	.63	5.71	.25	.06			
1-1/4	12	1019356	1019365	9.06	2.03	1.38	1.38	1.25	4.53	3.00	3.97	7.50	.69	6.25	.25	.13			
1-3/8	13-1/2	1019374	1019383	11.63	2.25	1.50	1.50	1.38	5.01	3.31	4.43	8.28	.75	6.53	.25	.13			
1-1/2	17	1019392	1019409	15.95	2.38	1.63	1.62	1.50	5.38	3.62	4.87	9.05	.81	7.33	.25	.13			
1-3/4	25	1019418	1019427	26.75	2.88	2.00	2.12	1.75	6.38	4.19	5.78	10.97	1.00	9.06	.25	.13			
2	35	1019436	1019445	42.31	3.25	2.25	2.36	2.10	7.25	5.00	6.77	12.74	1.13	10.35	.25	.13			
2-1/2	55	1019454	1019463	71.75	4.12	2.75	2.63	2.63	9.38	5.68	8.07	14.85	1.38	13.00	.25	.25			

* NOTE: Maximum Proof Load is 2.0 times the Working Load Limit. Minimum Ultimate Strength is 6 times the Working Load Limit. For Working Load Limit reduction due to side loading applications.



Crosby® Alloy Screw Pin Shackles

Load Rated®



G-209A



G-209A Screw pin anchor shackles meet the performance requirements of Federal Specification RR-C-271F Type IVA, Grade B, Class 2, except for those provisions required of the contractor.

- Capacities 2 thru 21 metric tons. Meets performance requirements of Grade 8 shackles.
- Forged Alloy Steel – Quenched and Tempered, with alloy pins.
- Working Load Limit permanently shown on every shackle.
- Hot Dip Galvanized.
- Shackles can be furnished proof tested with certificates to designated standards, such as ABS, DNV, Lloyds, or other certification. Charges for proof testing and certification available when requested at the time of order.
- Approved for use at -40 degree C (-40 degree F) to 204 degree C (400 degree F).
- Meets or exceeds all requirements of ASME B30.26 including identification, ductility, design factor, proof load and temperature requirements. Importantly, these shackles meet other critical performance requirements including fatigue life, impact properties and material traceability, not addressed by ASME B30.26.

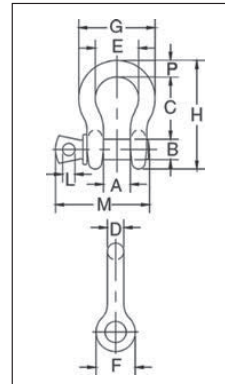

2

G-209A Crosby® Alloy Screw Pin Shackles

Nominal Size (in.)	Working Load Limit (t)*	G-209A Stock No.	Weight Each (lbs.)	Dimensions (in.)												Tolerance +/-	
				A	B	C	D	E	F	G	H	L	M	P	C	A	
3/8	2	1017450	.31	.66	.44	1.44	.38	1.03	.91	1.78	2.49	.25	2.03	.38	.13	.06	
7/16	2-2/3	1017472	.38	.75	.50	1.69	.44	1.16	1.06	2.03	2.91	.31	2.38	.44	.13	.06	
1/2	3-1/3	1017494	.63	.81	.63	1.88	.50	1.31	1.19	2.31	3.28	.38	2.69	.50	.13	.06	
5/8	5	1017516	1.38	1.06	.75	2.38	.63	1.69	1.50	2.94	4.19	.44	3.34	.69	.13	.06	
3/4	7	1017538	2.35	1.25	.88	2.81	.75	2.00	1.81	3.50	4.97	.50	3.97	.81	.25	.06	
7/8	9-1/2	1017560	3.61	1.44	1.00	3.31	.88	2.28	2.09	4.03	5.83	.50	4.50	.97	.25	.06	
1	12-1/2	1017582	5.32	1.69	1.13	3.75	1.00	2.69	2.38	4.69	6.56	.56	5.07	1.06	.25	.06	
1-1/8	15	1017604	7.25	1.81	1.25	4.25	1.16	2.91	2.69	5.16	7.47	.63	5.59	1.25	.25	.06	
1-1/4	18	1017626	9.88	2.03	1.38	4.69	1.29	3.25	3.00	5.75	8.25	.69	6.16	1.38	.25	.06	
1-3/8	21	1017648	13.25	2.25	1.50	5.25	1.42	3.63	3.31	6.38	9.16	.75	6.84	1.50	.25	.13	

* Maximum Proof Load is 2 times the Working Load Limit (metric tons) and 2.2 times the Working Load Limit (short tons). Minimum Ultimate Strength is 4.5 times the Working Load Limit for metric tonnes, and 5 times the Working Load Limit for short tons. For Working Load Limit reduction due to side loading applications.

Load Rated®



G-2169



S-2169



- Capacities of 7, 12.5 and 18 metric tons.
- Quenched and Tempered for maximum strength.
- Forged Alloy Steel.
- Available in galvanized and self colored finished.
- Individually proof tested and magnetic particle inspected. Crosby certification available at time of order.
- Meets or exceeds all requirements of ASME B30.26 including identification, ductility, design factor, proof load and temperature requirements. Importantly, these shackles meet other critical performance requirements including fatigue life, impact properties and material traceability, not addressed by ASME B30.26.
- Look for the Red Pin® . . . the mark of genuine Crosby quality.

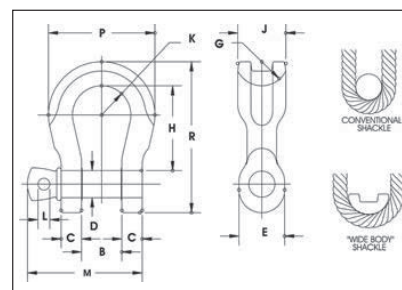

G-2169 / S-2169 Screw Pin "Wide Body" Shackles

Working Load Limit (t)*	G-2169 Stock No.	S-2169 Stock No.	Weight Each (lbs.)	Dimensions (in.)											
				B +/- .25	C	D +/- .02	E	G	H	J	K	L	M	P	R
7	1021655	1021664	3.5	1.25	.69	.88	1.82	1.25	3.56	1.60	1.25	.50	3.97	4.10	5.87
12.5	1021673	1021682	8.8	1.69	.92	1.13	2.38	1.37	4.63	2.13	1.63	.56	5.13	5.51	7.63
18	1021691	1021699	13	2.03	1.16	1.38	2.69	1.50	5.81	2.50	2.00	.69	6.25	6.76	9.38

* Ultimate Load is 5 times the Working Load Limit. Forged Alloy Steel. Proof Load is 2 times the Working Load Limit.



Crosby® Bolt Type Shackles

Load Rated®

Fatigue Rated®



QUIC-CHECK®

MAXTOUGH®



BOLT TYPE ANCHOR SHACKLES



G-2130 / S-2130

G-2130 Bolt Type Anchor shackles with thin head bolt - nut with cotter pin. Meets the performance requirements of Federal Specification RR-C-271F Type IVA, Grade A, Class 3, except for those provisions required of the contractor.

BOLT TYPE CHAIN SHACKLES



G-2150 / S-2150

G-2150 Bolt Type Chain shackles. Thin hex head bolt - nut with cotter pin. Meets the performance requirements of Federal Specification RR-C-271F Type IVB, Grade A, Class 3, except for those provisions required of the contractors.

- Capacities 1/3 thru 150 metric tons, grade 6.
- Working Load Limit and grade "6" permanently shown on every shackle.
- Forged - Quenched and Tempered, with alloy pins.
- Hot Dip galvanized or Self Colored. (85, 120, and 150 metric ton shackles are all hot dip galvanized bows and the bolts are Dimetcoated® and painted red)
- Fatigue rated (1/3t - 55t).
- Shackles 25t and larger are **RFID EQUIPPED**.
- Approved for use at -40 degree C (-40 degree F) to 204 degree C (400 degree F).
- Meets or exceeds all requirements of ASME B30.26.
- Shackles 85 metric tons and larger are individually proof tested to 2.0 times the working load limit.
- Shackles 120 metric tons and larger are proof tested, Magnetic Particle Inspected and provided with Serialized Pin and Bow.
- Type Approval and certification in accordance with ABS 2006 Steel Vessel Rules 1-1-17.7, and ABS Guide for Certification of Cranes.
- 3.1 Certification as standard available for charpy and statistical proof test for pg 79 only up to 25 tons to DNV2.7-1 and EN13889.
- Crosby 2t through 25t G2130 anchor shackles are type approved to DNV Certification Notes 2.7-1- Offshore Containers. These Crosby shackles are statistical proof and impact tested to 42 joules (31 ft-lbs.) min. ave. at -20 degree C (-4 degree F). The tests are conducted by Crosby and 3.1 test certification is available upon request. Refer to page 76 for Crosby COLD TUFF® shackles that meet the additional requirements of DNV rules for certification of lifting applications - Loose Gear.
- All other 2130 and all 2150 shackles can meet charpy requirements of 42 joules (31 ft-lbs) avg at -20 degree C (-4 degree F) upon special request.
- Look for the Red Pin® . . . the mark of genuine Crosby quality.

G-2130 / S-2130

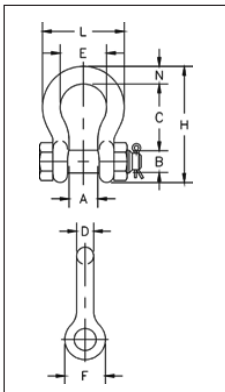

Nominal Size (in.)	Working Load Limit (t)*	Stock No.		Weight Each (lbs.)	Dimensions (in.)										Tolerance +/-	
		G-2130	S-2130		A	B	C	D	E	F	H	L	N	C	A	
3/16	1/3 ‡	1019464	-	.06	.38	.25	.88	.19	.60	.56	1.47	.98	.19	.06	.06	
1/4	1/2	1019466	-	.11	.47	.31	1.13	.25	.78	.61	1.84	1.28	.25	.06	.06	
5/16	3/4	1019468	-	.22	.53	.38	1.22	.31	.84	.75	2.09	1.47	.31	.06	.06	
3/8	1	1019470	-	.33	.66	.44	1.44	.38	1.03	.91	2.49	1.78	.38	.13	.06	
7/16	1-1/2	1019471	-	.49	.75	.50	1.69	.44	1.16	1.06	2.91	2.03	.44	.13	.06	
1/2	2	1019472	1019481	.79	.81	.64	1.88	.50	1.31	1.19	3.28	2.31	.50	.13	.06	
5/8	3-1/4	1019490	1019506	1.68	1.06	.77	2.38	.63	1.69	1.50	4.19	2.94	.69	.13	.06	
3/4	4-3/4	1019515	1019524	2.72	1.25	.89	2.81	.75	2.00	1.81	4.97	3.50	.81	.25	.06	
7/8	6-1/2	1019533	1019542	3.95	1.44	1.02	3.31	.88	2.28	2.09	5.83	4.03	.97	.25	.06	
1	8-1/2	1019551	1019560	5.66	1.69	1.15	3.75	1.00	2.69	2.38	6.56	4.69	1.06	.25	.06	
1-1/8	9-1/2	1019579	1019588	8.27	1.81	1.25	4.25	1.13	2.91	2.69	7.47	5.16	1.25	.25	.06	
1-1/4	12	1019597	1019604	11.71	2.03	1.40	4.69	1.29	3.25	3.00	8.25	5.75	1.38	.25	.06	
1-3/8	13-1/2	1019613	1019622	15.83	2.25	1.53	5.25	1.42	3.63	3.31	9.16	6.38	1.50	.25	.13	
1-1/2	17	1019631	1019640	19.00	2.38	1.66	5.75	1.53	3.88	3.63	10.00	6.88	1.62	.25	.13	
1-3/4	25	1019659	1019668	33.91	2.88	2.04	7.00	1.84	5.00	4.19	12.34	8.80	2.25	.25	.13	
2	35	1019677	1019686	52.25	3.25	2.30	7.75	2.08	5.75	4.81	13.68	10.15	2.40	.25	.13	
2-1/2	55	1019695	1019702	98.25	4.13	2.80	10.50	2.71	7.25	5.69	17.90	12.75	3.13	.25	.25	
3	† 85	1019711	-	154.00	5.00	3.30	13.00	3.12	7.88	6.50	21.50	14.62	3.62	.25	.25	
3-1/2	† 120 ‡	1019739	-	265.00	5.25	3.76	14.63	3.62	9.00	8.00	24.88	17.02	4.38	.25	.25	
4	† 150 ‡	1019757	-	338.00	5.50	4.26	14.50	4.00	10.00	9.00	25.68	18.00	4.56	.25	.25	

G-2150 / S-2150

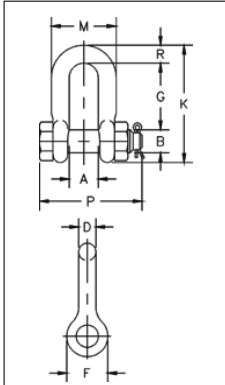

Nominal Size (in.)	Working Load Limit (t)*	Stock No.		Weight Each (lbs.)	Dimensions (in.)										Tolerance +/-	
		G-2150	S-2150		A	B	D	F	G	K	M	P	R	G	A	
1/4	1/2	1019768	-	.13	.47	.31	.25	.62	.91	1.59	.97	1.56	.25	.06	.06	
5/16	3/4	1019770	-	.23	.53	.38	.31	.75	1.07	1.91	1.15	1.82	.31	.06	.06	
3/8	1	1019772	-	.33	.66	.44	.38	.92	1.28	2.31	1.42	2.17	.38	.13	.06	
7/16	1-1/2	1019774	-	.49	.75	.50	.44	1.06	1.48	2.67	1.63	2.51	.44	.13	.06	
1/2	2	1019775	1019784	.75	.81	.64	.50	1.18	1.66	3.03	1.81	2.80	.50	.13	.06	
5/8	3-1/4	1019793	1019800	1.47	1.06	.77	.63	1.50	2.04	3.76	2.32	3.56	.63	.13	.06	
3/4	4-3/4	1019819	1019828	2.52	1.25	.89	.75	1.81	2.40	4.53	2.75	4.15	.81	.25	.06	
7/8	6-1/2	1019837	1019846	3.85	1.44	1.02	.88	2.10	2.86	5.33	3.20	4.82	.97	.25	.06	
1	8-1/2	1019855	1019864	5.55	1.69	1.15	1.00	2.38	3.24	5.94	3.69	5.39	1.00	.25	.06	
1-1/8	9-1/2	1019873	1019882	7.60	1.81	1.25	1.13	2.68	3.61	6.78	4.07	5.90	1.25	.25	.06	
1-1/4	12	1019891	1019908	10.81	2.03	1.40	1.25	3.00	3.97	7.50	4.53	6.69	1.38	.25	.06	
1-3/8	13-1/2	1019917	1019926	13.75	2.25	1.53	1.38	3.31	4.43	8.28	5.01	7.21	1.50	.25	.13	
1-1/2	17	1019935	1019944	18.50	2.38	1.66	1.50	3.62	4.87	9.05	5.38	7.73	1.62	.25	.13	
1-3/4	25	1019953	1019962	31.40	2.88	2.04	1.75	4.19	5.82	10.97	6.38	9.33	2.12	.25	.13	
2	35	1019971	1019980	46.75	3.25	2.30	2.10	5.00	6.82	12.74	7.25	10.41	2.36	.25	.13	
2-1/2	55	1019999	1020004	85.00	4.12	2.80	2.63	5.68	8.07	14.85	9.38	13.58	2.63	.25	.25	
3	† 85	1020013	-	124.25	5.00	3.25	3.00	6.50	8.56	16.87	11.00	15.13	3.50	.25	.25	

* NOTE: Maximum Proof Load is 2.0 times the Working Load Limit. Minimum Ultimate Strength is 6 times the Working Load Limit. For Working Load Limit reduction due to side loading applications, see page 91.

† Individually Proof Tested with certification.

‡ Furnished in Anchor style only and furnished with Round Head Bolts with welded handles.



Crosby® Alloy Bolt Type Shackles

Load Rated **QT** QUIC-CHECK® **MAXTOUGH** TYPE APPROVED

G-2130A ALLOY BOLT TYPE SHACKLES GRADE 80



G-2130A
Bolt Type Anchor shackles with thin head bolt – nut with cotter pin. Meets the performance requirements of Federal Specification RR-C-271F Type IVA, Grade B, Class 3, except for those provisions required of the contractor.

- Capacities 2 to 17 metric tons.
- Working Load Limit permanently shown on every shackle.
- Forged Alloy Steel – Quenched and Tempered, with bow and bolt.
- Hot Dip galvanized.
- Shackles can be **RFID EQUIPPED**.
- Meets or exceeds all requirements of ASME B30.26 including identification, ductility, design factor, proof load and temperature requirements. Importantly, these shackles meet other critical performance requirements including impact properties and material traceability, not addressed by ASME B30.26.
- Shackles can be furnished proof tested with certificates to designated standards, such as ABS, DNV, Lloyds, or other certification when requested at time of order.
- Type Approval and certification in accordance with DNV Type Approval under DNV 2.7-1.
- Shackles are Quenched and Tempered and meets DNV impact requirements of 42 joules (31 ft. lbs.) at -40 degree C (-40 degree F).

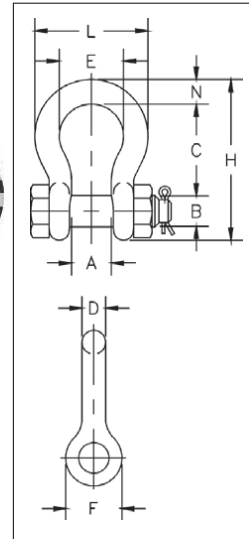

2

G-2130A Alloy Bolt Type Shackles Grade 80

Nominal Size (in.)	Working Load Limit (t)*	G-2130A Stock No.	Weight Each (lbs.)	Dimensions (in)									Tolerance +/-	
				A	B	C	D	E	F	H	L	N	C	A
1/2	2	1219472	.79	.81	.63	1.88	0.50	1.31	1.19	3.29	2.30	0.50	0.13	0.06
5/8	3-1/4	1219491	1.37	1.06	.75	2.38	0.63	1.69	1.50	4.18	2.94	0.69	0.25	0.06
3/4	4-3/4	1219516	2.71	1.25	.88	2.82	0.75	2.01	1.81	4.96	3.51	0.81	0.25	0.06
7/8	6-1/2	1219534	3.95	1.44	1.00	3.31	0.88	2.29	2.09	5.83	4.02	0.97	0.25	0.06
1	8-1/2	1219552	5.03	1.69	1.10	3.76	1.00	2.70	2.38	6.58	4.69	1.06	0.25	0.06
1-1/8	9-1/2	1219578	8.27	1.81	1.25	4.26	1.13	2.92	2.70	7.49	5.16	1.25	0.25	0.06
1-1/4	12	1219598	11.7	2.03	1.38	4.69	1.25	3.25	2.99	8.27	5.75	1.38	0.25	0.06
1-3/8	13-1/2	1219614	15.8	2.25	1.50	5.24	1.38	3.62	3.31	9.18	6.38	1.50	0.25	0.13
1-1/2	17	1219632	19.0	2.38	1.63	5.75	1.50	3.88	3.62	10.0	6.90	1.62	0.25	0.13

* NOTE: Maximum Proof Load is 2.0 times the Working Load Limit. Minimum Ultimate Strength is 8 times the Working Load Limit. For Working Load Limit reduction due to side loading applications.



Crosby® Alloy Bolt Type Shackles

Load Rated®



G-2140 / S-2140 ALLOY BOLT TYPE ANCHOR SHACKLES



G-2140 meets the performance requirements of Federal Specification RR-C-271E, Type IVA, Grade B, Class 3, except for those provisions required of the contractor.

- Quenched and Tempered.
- Alloy bows, Alloy bolts.
- Forged Alloy Steel 30 thru 200 metric tons and Cast Alloy Steel 250 thru 400 metric tons. Meets performance requirements of Grade 8 shackles.
- Working Load Limit is permanently shown on every shackle.
- 30, 40, 55, and 85 metric ton shackle bows are available galvanized or self colored with pins that are galvanized and painted red.
- 120, 150, 175 metric ton shackle bows are hot-dip galvanized; pins are Dimetcoted® and painted red.
- 200, 250, 300 and 400 metric ton shackle bows are Dimetcoted®; pins are Dimetcoted® and painted red.
- All sizes are **RFID EQUIPPED**.
- Approved for use at -40 degree C (-40 degree F) to 204 degree C (400 degree F).
- Shackles are Quenched and Tempered and can meet DNV impact requirements of 42 joules (31 ft-lbs.) at -20 degree C (-4 degree F).
- All sizes are individually proof tested to 2.0 times the Working Load Limit.

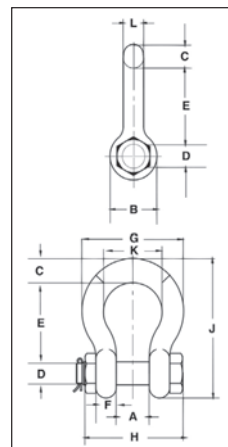

G-2140E Crosby Easy-Loc®

- Shackles 200 metric tons and larger are provided as follows.
 - Serialized Pin and Bow
 - Material Certification (Chemical)
 - Magnetic Particle Inspected.
 - Certification must be requested at time of order.
- Meets or exceeds all requirements of ASME B30.26 including identification, ductility, design factor, proof load and temperature requirements. Importantly, these shackles meet other critical performance requirements including fatigue life, impact properties and material traceability, not addressed by ASME B30.26.
- Type Approval and certification in accordance with ABS 2006 Steel Vessel Rules 1-1-17.7, and ABS Guide for Certification of Cranes.
- Look for the Red Pin® . . . the mark of genuine Crosby quality.

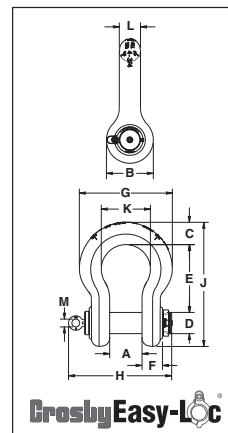

Crosby Easy-Loc®

G-2140E / S-2140E Crosby® Alloy Crosby Easy-Loc® Shackles

Nominal Shackle Size (in.)	Working Load Limit (t)*	Stock No.		Weight Each (lbs.)	Dimensions (in.)													Tolerance +/-	
		G-2140E	S-2140E		A	B	C	D +/- .02	E	F	G	H	J	K	L	M	A	E	
4-3/4	† 200	1021422	-	452	7.25	10.50	5.00	4.75	15.19	4.58	20.84	23.11	27.81	11.00	4.75	1.75	.25	.25	
5**	† 250	1021442	-	594	8.50	12.00	5.63	5.00	18.50	4.48	23.63	24.28	32.63	13.00	5.00	1.75	.25	.25	
6**	† 300	1021460	-	791	8.38	13.00	6.06	6.00	18.72	4.89	24.76	25.45	34.28	13.00	5.88	1.75	.25	.25	

G-2140 / S-2140 Crosby® Alloy Bolt Type Shackles

Nominal Shackle Size (in.)	Working Load Limit (t)*	Stock No.		Weight Each (lbs.)	Dimensions (in.)													Tolerance +/-	
		G-2140	S-2140		A	B	C	D +/- .02	E	F	G	H	J	K	L	A	E		
1-1/2	30	1021110	1021129	18.8	2.38	3.62	1.62	1.63	5.75	1.39	6.88	7.73	10.00	3.88	1.53	.13	.25		
1-3/4	40	1021138	1021147	33.8	2.88	4.19	2.25	2.00	7.00	1.75	8.81	9.33	12.34	5.00	1.84	.13	.25		
2	55	1021156	1021165	49.9	3.25	4.81	2.40	2.25	7.75	2.00	10.16	10.41	13.68	5.75	2.08	.13	.25		
2-1/2	85	1021174	1021183	103	4.12	5.81	3.12	2.75	10.50	2.62	12.75	13.58	17.90	7.25	2.71	.25	.25		
3	120	1021192	-	162	5.00	6.50	3.63	3.25	13.00	3.00	14.62	15.13	21.50	7.88	3.12	.25	.25		
3-1/2	† 150	1021218	-	268	5.25	8.00	4.38	3.75	14.63	3.75	17.02	17.62	24.88	9.00	3.62	.25	.25		
4	† 175	1021236	-	332	5.50	9.00	4.56	4.25	14.50	4.00	18.00	20.37	25.68	10.00	4.00	.25	.25		
7**	† 400	1021478	-	1200	8.25	14.00	7.25	7.00	22.50	6.50	26.00	28.68	40.25	13.00	6.00	.25	.25		

* Note: Maximum Proof Load is 2.0 times the Working Load Limit. Minimum Ultimate Load is 4 times the Working Load Limit on 200 thru 400 metric Tons. For sizes 30 thru 175 metric Tons, Minimum Ultimate Load is 5.4 times the Working Load Limit. ** Cast Alloy Steel. † Furnished with Round Head Bolts with an eyebolt for handling.



Crosby® Wide Body Shackles

Load Rated®



**G-2160 / S-2160
"WIDE BODY"
SHACKLES**



Patented



G-2160E

Crosby Easy-Loc®

- All sizes Quenched and Tempered for maximum strength.
- Forged alloy steel from 7 through 300 metric tons.
- Cast alloy steel from 400 through 1550 metric tons.
- Sizes 300 metric tons and smaller are proof tested to 2 times the Working Load Limit.
- Sizes 400 metric tons and larger are tested to 1.33 times Working Load Limit.
- All ratings are in metric tons, embossed on side of bow.
- G-2160, (7-55t), are Hot Dip Galvanized and pins are painted red.
- G-2160, (75t and larger), bows are furnished Dimetcoated, and pins are Dimetcoated, then painted red.
- S-2160 bows and pins are painted red.
- Shackles, 30t and larger, are **RFID EQUIPPED**.
- Can be used to connect HIGH STRENGTH Synthetic Web Slings, HIGH STRENGTH Synthetic Round Slings or Wire Rope Slings.
- Increase in shackle bow radius provides minimum 58% gain in sling bearing surface and eliminates need for a thimble.
- Increases usable sling strength minimum of 15% and greatly improves life of wire rope slings.
- Pin is non-rotating, with weld-on handles for easier use (75t and larger).
- Approved for use at -40 degree C (-40 degree F) to 204 degree C (400 degree F).
- Bow and bolt are Certified to meet charpy impact testing of 42 joules (31 ft-lbs.) min. ave. at -20 degree C (-4 degree F).
- All 2160 shackles are individually proof tested and magnetic particle inspected. Crosby certification available at time of order.
- Shackles requiring ABS, Lloyds and other certifications are available upon special request and must be specified at time of order.
- Shackles 18t and larger have DNV Type Approval to Rules for Certification of Lifting Appliances, and are produced in accordance with DNV MSA requirements. Databook is provided that includes required documents.
 - Serialization / Identification
 - Material Testing (Physical / Chemical / Charpy)
 - Proof Testing
- Look for the Red Pin® ... the mark of genuine Crosby quality.

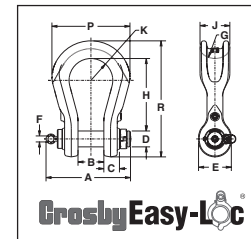
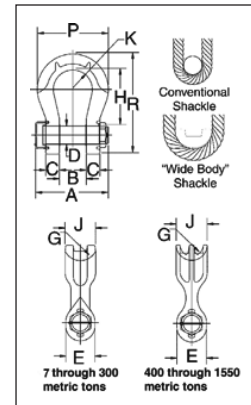

2

G-2160E / S-2160E Crosby® Crosby Easy-Loc® "Wide Body" Shackles

Working Load Limit (t)*	Stock No.		Weight Each (lbs.)	Dimensions (in.)													Effective Body Diameter
	G-2160E	S-2160E		A	B +/- .25	C	D +/- .02	E	F	G	H	J	K	P	R		
125	1021309	-	178	16.75	5.12	3.50	3.15	6.50	1.19	3.75	14.36	5.91	4.33	15.47	23.00	6.8	
200	1021320	-	401	19.76	5.91	4.94	4.12	8.41	1.75	5.25	18.90	8.63	5.41	20.47	30.44	9.5	
300	1021330	-	777	23.05	7.38	5.63	5.25	10.50	1.75	6.13	23.63	10.38	6.31	23.83	37.51	11.4	

G-2160 / S-2160 Crosby® "Wide Body" Shackles

Working Load Limit (t)*	Stock No.		Weight Each (lbs.)	Dimensions (in.)													Effective Body Diameter
	G-2160	S-2160		A	B +/- .25	C	D +/- .02	E	G	H	J	K	P	R			
7	1021256	1021548	4.0	4.14	1.25	.69	.88	1.82	1.25	3.56	1.60	1.25	4.10	5.87	2.1		
12.5	1021265	1021557	8.80	5.38	1.69	.92	1.13	2.38	1.37	4.63	2.13	1.63	5.51	7.63	2.4		
18	1021274	1021566	14.90	6.69	2.03	1.16	1.38	2.69	1.50	5.81	2.50	2.00	6.76	9.38	2.8		
30	1021283	1021575	26.50	7.69	2.37	1.38	1.63	3.50	2.50	6.94	3.13	2.50	8.50	11.38	4.1		
40	1021285	1021584	46.00	9.28	2.88	1.69	2.00	4.00	1.75	8.06	3.75	3.00	10.62	13.62	3.6		
55	1021287	1021593	68.00	10.36	3.25	2.00	2.25	4.63	2.63	9.36	4.50	3.50	12.26	15.63	4.3		
75	1021290	-	99.00	14.37	4.13	2.12	2.75	5.34	2.50	11.53	4.75	3.64	12.64	18.66	5.0		
400	1021334	-	1130	30.27	8.66	5.16	6.30	11.81	6.30	22.64	12.60	7.28	27.17	38.78	14.3		
500	1021343	-	1440	33.35	9.84	5.73	7.09	13.39	6.69	24.81	13.39	8.86	31.10	42.72	14.8		
600	1021352	-	1995	36.02	10.83	6.23	7.87	15.50	7.28	27.56	14.57	9.74	34.06	47.24	20.3		
700	1021361	-	2415	38.91	11.81	6.59	8.46	14.80	7.87	28.94	15.75	10.63	37.01	50.18	16.6		
800	1021254	-	2880	41.66	12.80	7.30	9.06	16.54	8.27	29.53	16.54	10.92	38.39	52.09	18.0		
900	1021389	-	3628	43.73	13.78	7.78	9.84	16.93	8.66	29.82	17.32	11.52	40.35	54.04	22.4		
1000	1021370	-	4155	45.98	14.96	8.33	10.63	17.72	9.06	29.92	18.11	12.11	42.32	55.31	19.3		
1250	1021272	-	5320	49.86	16.93	9.15	11.81	21.00	10.43	36.61	20.87	12.70	46.26	65.35	24.4		
1550	1021281	-	8302	54.89	18.31	10.58	12.60	23.82	15.92	42.32	22.82	13.29	49.41	73.43	27.3		

* 7t-300t Proof Load is 2 times the Working Load Limit. Ultimate Load is 5 times the Working Load Limit.
400t-1550t Proof Load is 1.33 times the Working Load Limit. Ultimate Load is 4.5 times the Working Load Limit.



Crosby® Grommet Shackle

Load Rated®



2

G-2170 GROMMET SHACKLE



Scan our QR Code with your smart device to visit the online flyer.

- All sizes Quenched and Tempered for maximum strength.
- All sizes cast alloy steel.
- Sizes 300 metric tons and smaller are proof tested to 2 times the Working Load Limit.
- All ratings are in metric tons, embossed on side of bow.
- G-2170 bows are furnished Dimetcoated and pins are Dimetcoated, then painted red.
- All sizes are RFID Equipped in bow and pin
- Designed for use with single or double large diameter grommets.
- Extra large sling contact area improves efficiency of the grommet sling.
- Utilizes new **Crosby Easy-Loc** shackle bolt system
- Large machined flat on ears that can be drilled and tapped for adapting other accessories.
- HR-1000 Hoist Ring in Bow available for easy transporting
- Provides a bearing surface that is at least 5 times that of a round shackle.
- Increases usable sling strength minimum of 60% and greatly improves life of grommet slings.
- Bow and bolt are certified to meet charpy impact testing of 42 joules (31 ft-lbs.) min. ave. at -20 degree C (-4 degree F).
- All 2170 shackles are individually proof tested and magnetic particle inspected. Crosby certification available at time of order.
- Shackles requiring ABS, Lloyds, and other certifications are available upon special request and must be specified at time of order.
- All 2170 shackles can meet requirements of DNV Standard for Certification of Lifting Appliances upon special request and must be specified at time of order.
 - Serialization / Identification
 - Material Testing (Physical / Chemical / Charpy)
 - Proof Testing
- Look for the Red Pin®...the mark of genuine Crosby quality.

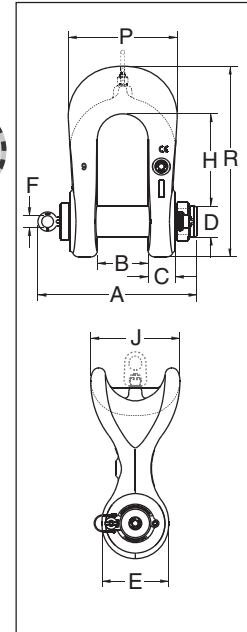

G-2170 Crosby® Grommet Shackles

Working Load Limit (t)*	Stock No.	Weight Each (lbs.)	Dimensions (in.)										Effective Body Diameter
			A	B +/- .025	C	D +/- .02	E	F	H	J	P	R	
75	1022075	113	14.08	4.13	2.39	2.75	5.50	1.19	7.77	7.50	9.50	16.20	11.25
125	1022084	176	16.05	5.13	2.75	3.15	6.72	1.19	9.31	9.00	11.00	19.25	13.50
200	1022093	368	19.13	5.91	3.39	4.12	9.00	1.75	11.64	12.90	13.63	25.01	18.45
300	1022100	686	22.44	7.38	4.30	5.25	11.13	1.75	15.20	15.50	17.00	31.82	22.75

* Sizes 75-300 metric tons are proof tested to 2 times the Working Load Limit. Ultimate Load is 5 times the Working Load Limit. Ultimate Load is 4.5 times the Working Load Limit.



Crosby® COLD TUFF® Shackles

Fatigue Rated®



G-2130CT
and
G-2140CT



- Forged - Quenched and Tempered, with alloy bolt.
 - G-2130CT - Carbon Steel
 - G-2140CT - Alloy Steel
- Working Load Limit permanently shown on every shackle.
- Individually Serialized with Certification.
- Fatigue Rated (G-2130CT only).
- Shackles 25t and larger are **RFID EQUIPPED**.
- All sizes are individually proof tested to 2.0 times the Working Load Limit.
- Finish is Inorganic Zinc Primer or Hot Dipped Galvanized.
- Bow and Bolt are Certified to meet Charpy impact testing of 42 joules (31 ft-lbs.) min. ave. at -20 degree C (-4 degree F).
- Individually Mag Inspected with certification.
- COLD TUFF® shackles are suitable for use to -50° F.
- Type Approval and certification in accordance with DNV 2.7-1 Offshore Containers, and Rules for Certification of Lifting Appliances, DNV OS-101, and are produced in accordance with DNV MSA requirements, including required documents.

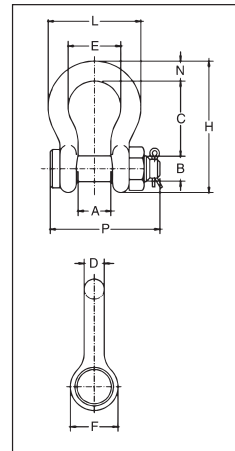

2

G-2130CT

- Bolt Type Anchor shackle with thin head bolt - nut with cotter pin. Meets the performance requirements of Federal Specification RR-C2.7-1F Type IVA, Grade A, Class 3, except for those provisions required of the contractor.

Nominal Shackle Size (in.)	Working Load Limit (t)*	G-2130CT Stock No.	Weight Each (lbs.)	Dimensions (in.)											Tolerance +/-	
				A	B	C	D	E	F	H	L	N	P	A	C	
3/4	4-3/4	1260568	2.72	1.25	.88	2.81	.75	2.00	1.81	4.97	3.50	.81	4.25	.06	.25	
7/8	6-1/2	1260577	3.87	1.44	1.00	3.31	.88	2.28	2.09	5.83	4.03	.97	4.71	.06	.25	
1	8-1/2	1260586	5.66	1.69	1.13	3.75	1.03	2.69	2.38	6.56	4.69	1.06	5.38	.06	.25	
1-1/8	9-1/2	1260595	8.26	1.81	1.25	4.25	1.13	2.91	2.69	7.47	5.16	1.25	5.90	.06	.25	
1-1/4	12	1260604	11.71	2.03	1.38	4.69	1.29	3.25	3.00	8.25	5.75	1.38	6.63	.06	.25	
1-3/8	13-1/2	1260613	15.1	2.25	1.50	5.25	1.38	3.63	3.31	9.16	6.38	1.50	7.21	.13	.25	
1-1/2	17	1260622	20.8	2.38	1.63	5.75	1.54	3.88	3.63	10.00	6.88	1.62	7.66	.13	.25	
1-3/4	25	1260633	33.9	2.88	2.00	7.00	1.84	5.00	4.19	12.34	8.86	2.25	9.19	.13	.25	

* NOTE: Maximum Proof Load is 2.0 times the Working Load Limit.
4-3/4t - 25t, Minimum Ultimate Load is 5.4 times the Working Load Limit.

G-2140CT

- G-2140 meets the performance requirements of Federal Specifications RR-C-271F, Type IVA, Grade B, Class 3 except for those provisions required of the contractor.

Nominal Shackle Size (in.)	Working Load Limit (t)*	G-2140CT Stock No.	Weight Each (lbs.)	Dimensions (in.)											Tolerance +/-	
				A	B	C	D	E	F	H	L	N	P	A	C	
1-1/2	30	1260801	20.8	2.38	1.63	5.75	1.54	3.88	3.62	10.00	6.88	1.62	7.73	.13	.25	
1-3/4	40	1260812	33.9	2.88	2.00	7.00	1.84	5.00	4.19	12.34	8.81	2.25	9.33	.13	.25	
2	55	1260823	52.0	3.25	2.25	7.75	2.08	5.75	4.81	13.68	10.16	2.40	10.41	.13	.25	
2-1/2	85	1260834	96.0	4.12	2.75	10.50	2.72	7.25	5.69	17.84	12.87	3.12	13.58	.25	.25	
3	120	1260843	178.0	5.00	3.25	13.00	3.11	7.88	6.50	21.50	14.36	3.63	15.13	.25	.25	
3-1/2	† 150	1260852	265.0	5.25	3.75	14.63	3.62	9.00	8.00	24.62	16.50	4.12	17.62	.25	.25	
4	† 175	1260861	338.0	5.50	4.25	14.5	4.10	10.00	9.00	25.69	18.42	4.56	20.37	.25	.25	
4-3/4	† 200	1260870	450.0	7.25	4.75	15.63	4.50	11.00	10.50	29.25	21.00	6.00	21.21	.25	.25	
5	† 250	1260889	600.0	8.50	5.00	20.00	4.50	13.00	12.00	35.00	24.50	6.50	22.68	.25	.25	

* NOTE: Maximum Proof Load is 2.0 times the Working Load Limit.
30t - 175t, Minimum Ultimate Load is 5.4 times the Working Load Limit.
200t and larger, Minimum Ultimate Load is 4 times the Working Load Limit.
† Furnished with Round Head Bolts with welded handle.



Crosby® Specialty Shackles

Load Rated® Fatigue Rated® **QT** QUIC-CHECK®
MAXTOUGH®

2

S-209T THEATRICAL SHACKLES



- Sizes: 3/8" through 3/4"
- Capacities: 1 through 4-3/4 metric tonnes.
- Forged - Quenched and Tempered, with alloy pins.
- Working Load Limit permanently shown on every shackle.
- Flat black baked on power coat finish.
- Fatigue Rated.
- Industry leading 6 to 1 design factor.
- Screw pin anchor shackles meet the performance requirement of Federal Specification RR-C-271F Type A, Grade A, Class 2, except for those provisions required of the contractor.
- Meets the performance requirements of EN 13889:2003.
- Meets or exceeds all requirements of ASME B30.26 including identification, ductility, design factor, proof load and temperature requirements. Importantly, these shackles meet other critical performance requirements including fatigue life, impact properties and material traceability, not addressed by ASME B30.26.

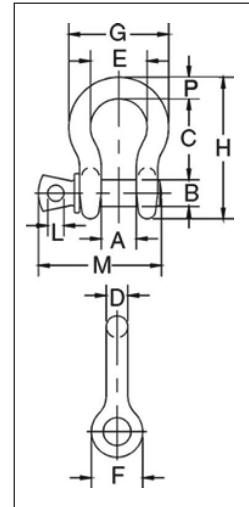

S-209T Theatrical Shackles

Nominal Size (in.)	Working Load Limit (t)*	S-209T Stock No.	Weight Each (lbs.)	Dimensions (in.)												Tolerance +/-	
				A	B	C	D	E	F	G	H	L	M	P	C	A	
3/8	1	1018706	.31	.66	.44	1.44	.38	1.03	.91	1.78	2.49	.25	2.02	.38	.13	.06	
7/16	1-1/2	1018724	.38	.75	.50	1.69	.40	1.16	1.06	2.03	2.91	.31	2.37	.44	.13	.06	
1/2	2	1018742	.72	.81	.63	.188	.50	1.31	1.19	2.31	3.28	.38	2.69	.50	.13	.06	
5/8	3-1/4	1018760	1.37	1.06	.75	2.38	.63	1.69	1.50	2.94	4.19	.44	3.34	.69	.13	.06	
3/4	4-3/4	1018778	2.35	1.25	.88	2.81	.75	2.00	1.81	3.50	4.97	.50	3.97	.81	.25	.06	

* Minimum Ultimate Load is 5 times the Working Load Limit.



Wire Rope Thimbles

EXTRA HEAVY DUTY WIRE ROPE THIMBLES GALVANIZED STEEL

For Rope Diameter Inches	DIMENSIONS IN INCHES							Weight Pounds Per 100
	A Overall Length	B Overall Width	C Inside Length	D Inside Width	E Overall Thickness	F Inside Width of Score	Maximum Pin Diameter	
1/4	2 3/8	1 1/2	1 1/4	3/4	1 1/2	3/2	1 1/8	7.5
5/16	2 1/2	1 13/16	1 1/4	1 1/8	1 1/2	1 1/2	1 1/8	14.0
3/8	2 7/8	2 1/4	2 1/4	1 1/2	2 1/2	1 3/2	1 1/8	25.0
7/16	3 3/4	2 3/4	2 3/4	1 3/4	3	1 5/2	1 3/8	36.0
1/2-5/16	3 3/4	2 3/4	2 3/4	1 1/2	2 3/2	1 5/2	1 7/8	51.0
5/8	4 1/4	3 3/4	3 3/4	1 3/4	1	2 1/2	1 3/4	75.0
3/4	5	3 13/16	3 3/4	2	1 1/4	2 5/2	1 3/4	147.0
7/8	5 1/2	4 1/4	4 1/4	2 1/4	1 1/2	1 3/2	2 1/4	185.0
1	6 1/8	4 1 1/8	4 1/2	2 1/2	1 3/8	1 1/2	2 3/4	295.0
1 1/8-1 1/4	7	5 3/4	5 3/4	2 3/4	1 3/4	1 3/4	2 3/4	390.0
1 1/4-1 3/8	9 1/8	6 13/16	6 1/2	3 1/2	2 1/4	1 3/4	3 1/4	820.0
1 3/8-1 1/2	9	7 1/4	6 3/4	3 3/4	2 3/4	1 3/4	3 3/4	1175.0
1 1/2	11 1/4	8 3/4	8	4	2 3/4	1 2 3/2	3 3/4	1625.0
1 3/4	12 3/8	8 3/4	9	4 1/2	2 3/4	1 2 3/2	4 3/4	1800.0
1 3/8-2	15 1/2	10 3/4	12	6	3 1/4	2 3/2	5 3/4	2600.0
2 1/4	17 1/2	11 3/4	14	7	3 3/4	2 3/4	6 3/4	3880.0
2 1/2	20 3/4	13 1/2	15 3/4	8 3/4	4 1/4	2 3/4	8 1/4	7500.0

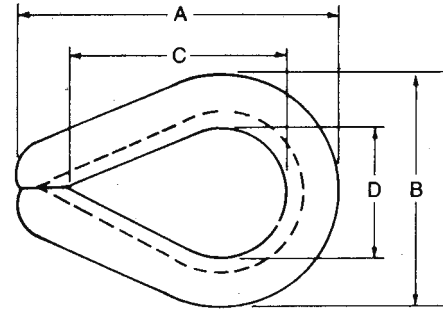

2

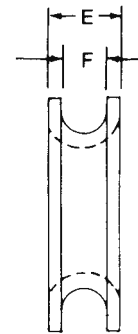

STAINLESS HEAVY DUTY WIRE ROPE THIMBLES

For Rope Diameter Inches	DIMENSIONS IN INCHES							Weight Pounds Per 100
	A Overall Length	B Overall Width	C Inside Length	D Inside Width	E Overall Thickness	F Inside Width of Score	Maximum Pin Diameter	
1/4	1 15/16	1 1/16	1 1/16	1 1/16	3/8	3/2	5/8	3.5
5/16	2 1/8	1 1/4	1 1/2	1 3/16	7/16	3/8	3/4	4.0
3/8	2 3/8	1 1 1/2	1 3/4	1 5/16	1 1/2	7/16	7/8	7.5
1/2	2 3/4	1 3/4	1 3/4	1 1/8	1 1/16	3/8	1 1/16	15.8
5/8	3 1/2	2 3/4	2 1/4	1 3/8	2 3/2	1 1/16	1 1/4	36.0
3/4	3 3/4	2 1 1/8	2 1/2	1 1/8	1 3/2	1 3/16	1 1/2	50.0
7/8	5	3 3/8	3 1/2	1 3/8	1 3/2	1 5/16	1 3/4	90.0
1	5 1 1/8	3 3/4	4 1/4	2 1/2	1 3/8	1 1/16	2 3/4	105.0
1 1/8-1 1/4	6 1/4	4 3/8	4 1/2	2 3/4	1 3/4	1 3/16	2 3/4	176.0

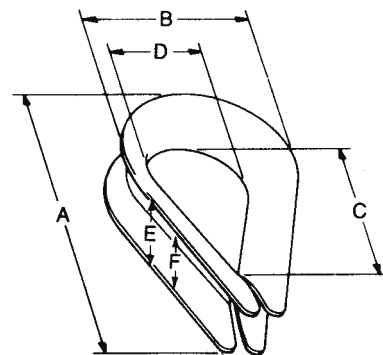

Meets or exceeds federal specification FF-T-276 (latest revision).



Equalizing Thimbles

2

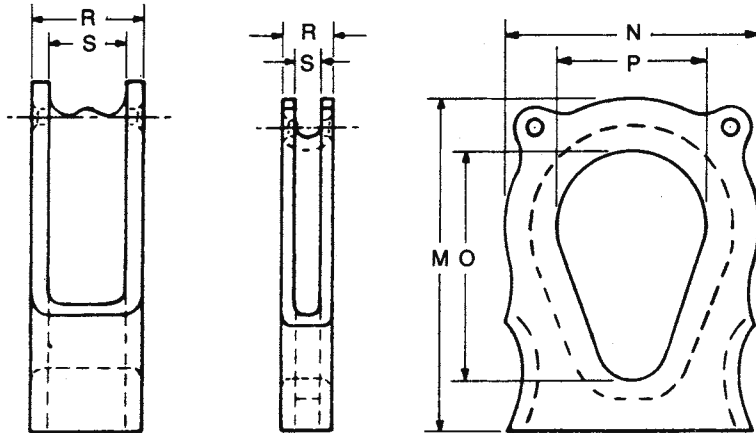

- Legs of bridle slings may be adjusted in length, using the equalizing thimble.
- For use in lifting unbalanced loads.

SINGLE GROOVE

CAST 1035 STEEL

Wire Rope Size Range	Dimensions in Inches						Wt. Lbs.
	M	N	O	P	R	S	
$\frac{3}{8}$ - $\frac{7}{16}$	6 $\frac{7}{16}$	4 $\frac{5}{8}$	4 $\frac{1}{2}$	3	$\frac{7}{8}$	$\frac{1}{2}$	3.0
$\frac{1}{2}$ - $\frac{5}{16}$	8 $\frac{1}{2}$	6 $\frac{3}{16}$	6	4	1 $\frac{1}{8}$	$\frac{5}{8}$	6.3
$\frac{5}{8}$ - $\frac{3}{4}$	9 $\frac{15}{16}$	7	7	4 $\frac{1}{2}$	1 $\frac{1}{16}$	1 $\frac{1}{16}$	9.8
$\frac{3}{4}$ -1	10 $\frac{3}{4}$	8 $\frac{3}{4}$	7 $\frac{1}{8}$	5	1 $\frac{1}{16}$	1 $\frac{3}{16}$	15.6
1 $\frac{1}{8}$ -1 $\frac{1}{4}$	14 $\frac{3}{8}$	10 $\frac{7}{8}$	10	6 $\frac{1}{2}$	2 $\frac{3}{16}$	1 $\frac{7}{16}$	28.0
1 $\frac{1}{8}$ -1 $\frac{1}{2}$	15 $\frac{5}{8}$	11 $\frac{3}{4}$	11	7 $\frac{1}{2}$	2 $\frac{3}{16}$	1 $\frac{15}{16}$	39.0
1 $\frac{1}{8}$ -1 $\frac{3}{4}$	20 $\frac{13}{16}$	14 $\frac{1}{4}$	15	9	2 $\frac{15}{16}$	1 $\frac{15}{16}$	65.0
1 $\frac{1}{8}$ -2	21 $\frac{5}{8}$	14 $\frac{7}{8}$	15	9	3 $\frac{3}{16}$	2 $\frac{3}{16}$	85.0

DOUBLE GROOVE

CAST 1035 STEEL

Wire Rope Size Range	Dimensions in Inches						Wt. Lbs.
	M	N	O	P	R	S	
$\frac{3}{8}$ - $\frac{3}{4}$	11 $\frac{1}{4}$	8	8 $\frac{1}{4}$	5 $\frac{1}{2}$	2 $\frac{3}{8}$	1 $\frac{3}{4}$	21.0
$\frac{3}{8}$ -1	12 $\frac{3}{4}$	8 $\frac{1}{2}$	9	6	2 $\frac{3}{8}$	2 $\frac{1}{4}$	28.0
1 $\frac{1}{8}$ -1 $\frac{1}{4}$	16	12 $\frac{1}{2}$	11 $\frac{1}{2}$	7 $\frac{1}{2}$	3 $\frac{1}{4}$	2 $\frac{3}{8}$	45.0

Larger sizes upon application.
Cast Alloy Available Upon Request.



Swage Sockets

CAUTION: When attaching swage sockets to wire rope it is extremely important to follow recommended procedures. **Read important warnings and information preceding fittings setting.**

Swage sockets are recommend for use on 6 x 19 or 6 x 36 IWRC regular lay ropes. They are also satisfactory on galvanized bridge rope. They are NOT recommended for use on fiber core or lang lay ropes. Spheroidized annealed for cold swaging. Sockets properly applied have an efficiency rating of 100%. This rating is based on the catalog breaking strength of wire rope.

OPEN SWAGE SOCKETS A/S indicates the proper dimension of A after swaging.

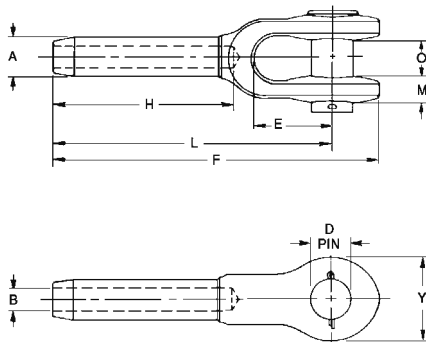

Rope Diameter in Inches	Dimensions in Inches										Approx. Weight Ea. in Pounds	A/S
	A	B	D	E	F	H	L	M	O	Y		
¼	.495	.272	.688	1.50	4.75	2.13	4.00	.31	.69	1.38	.55	.438
⅜	.770	.339	.812	1.75	6.25	3.19	5.31	.41	.81	1.63	1.10	.688
½	.770	.406	.812	1.75	6.25	3.19	5.31	.41	.81	1.63	1.08	.688
⅝	.982	.484	1.00	2.00	7.81	4.25	6.69	.50	1.00	2.00	2.30	.875
¾	.982	.547	1.00	2.00	7.81	4.25	6.69	.50	1.00	2.00	2.25	.875
⅞	1.257	.609	1.19	2.25	9.56	5.31	8.13	.63	1.25	2.50	4.60	1.125
1	1.257	.672	1.19	2.25	9.56	5.31	8.13	.63	1.25	2.50	4.50	1.125
1 ¼	1.545	.796	1.38	2.75	11.69	6.38	10.00	.75	1.50	3.00	7.80	1.375
1 ½	1.700	.938	1.63	3.25	13.63	7.44	11.63	.94	1.75	3.38	11.70	1.50
1 ¾	1.975	1.062	2.00	3.75	15.63	8.50	13.38	1.03	2.00	4.00	17.8	1.75
2	2.245	1.188	2.25	4.25	17.50	9.56	15.00	1.19	2.25	4.50	29.7	2.00
2 ¼	2.525	1.328	2.50	4.75	19.44	10.63	16.50	1.19	2.50	5.00	36.0	2.25
2 ½	2.800	1.453	2.50	5.25	21.25	11.69	18.13	1.31	2.50	5.25	47.0	2.50
2 ¾	3.075	1.578	2.75	5.75	23.25	12.75	19.75	1.44	3.00	5.75	65.0	2.75
3	3.385	1.859	3.50	6.75	27.13	14.88	23.00	1.69	3.50	7.00	93.0	3.00
3 ½	3.935	2.109	3.75	8.00	31.44	17.00	26.75	1.81	4.00	8.00	145.0	3.50

CLOSED SWAGE SOCKETS A/S indicates the proper dimension of A after swaging.

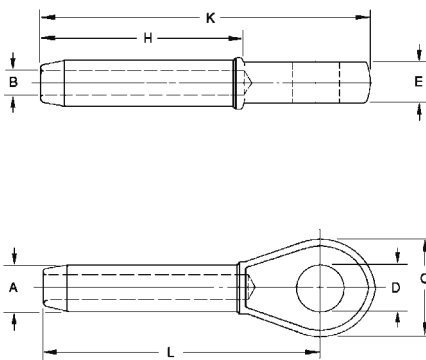

Rope Diameter in Inches	Dimensions in Inches								Approx. Weight Ea. in Pounds	A/S
	A	B	C	D	E	H	K	L		
¼	.495	.272	1.44	.750	.50	2.13	4.38	3.50	.34	.438
⅜	.770	.339	1.69	.875	.69	3.19	5.50	4.50	.79	.688
½	.770	.406	1.69	.875	.69	3.19	5.50	4.50	.78	.688
⅝	.982	.484	2.00	1.063	.88	4.25	6.94	5.75	1.45	.875
¾	.982	.547	2.00	1.063	.88	4.25	6.94	5.75	1.38	.875
⅞	1.257	.609	2.50	1.250	1.13	5.31	8.75	7.25	2.78	1.125
1	1.257	.672	2.50	1.250	1.13	5.31	8.75	7.25	2.75	1.125
1 ¼	1.545	.796	3.00	1.438	1.31	6.38	10.38	8.63	5.00	1.375
1 ½	1.700	.938	3.50	1.688	1.50	7.44	12.13	10.13	7.50	1.50
1 ¾	1.975	1.062	4.00	2.063	1.75	8.50	13.75	11.50	11.2	1.75
2	2.245	1.188	4.50	2.313	2.00	9.56	15.25	12.75	15.8	2.00
2 ¼	2.525	1.328	5.00	2.563	2.25	10.63	17.25	14.38	23.0	2.25
2 ½	2.800	1.453	5.25	2.563	2.25	11.69	18.88	15.75	31.0	2.50
2 ¾	3.075	1.578	5.50	2.813	2.50	12.75	20.38	17.00	39.0	2.75
3	3.385	1.859	6.75	3.563	3.00	14.88	24.00	20.00	52.0	3.00
3 ½	3.935	2.109	7.75	3.813	3.25	17.00	27.50	23.00	90.0	3.50



Open Wire Rope Spelter Sockets

2

Material Specification:

All cast sockets are ASTM, A148 steel, grade 90-60. All sockets are magnetic particle inspected at critical areas. Forged & cast sockets are proof tested on request.

Note: This drawing illustrates one groove used on sockets marked 1/2" & smaller. Sizes 5/16"-1 1/2" have two grooves. Sizes 1 5/8" & larger have three grooves.

Tolerances: Dimensions under 4", ±1/8"; over 4", ±1/4"

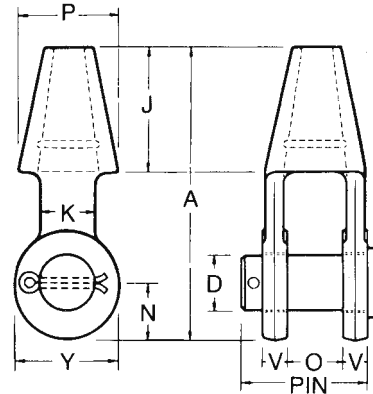

STANDARD OPEN WIRE ROPE SOCKETS

Meets Federal Specifications RR-S-550 (latest revision).

Rope Diameter	Dimensions In Inches								Pin		Wt Each In Pounds
	A	J	K	N	O	P	V	Y	Length	D Diameter	
1/4	4 5/16	2 1/4	3/8	3/8	1 1/16	1 1/16	5/16	1 1/16	1 3/4	1 1/16	1.1
5/16-3/8	4 7/16	2 1/4	13/16	7/8	13/16	1 1/8	7/16	1 1/2	2 1/4	13/16	1.3
3/8-1/2	5 3/16	2 1/2	1	1 1/16	1	1 1/8	1/2	1 1/8	2 3/8	1	2.3
5/16-5/8	6 3/16	3	1 1/4	1 1/4	1 1/4	2 1/4	5/8	2 1/4	2 3/4	1 3/16	3.8
3/4	7 1/16	3 1/2	1 1/2	1 1/16	1 1/2	2 3/8	3/4	2 3/8	3 1/4	1 3/8	6
7/8	9 1/4	4	1 3/4	1 3/4	1 3/4	3 3/8	7/8	3 3/8	3 3/8	1 1/8	10
1	10 5/16	4 1/2	2	2 1/16	2	3 3/8	7/8	3 3/4	4 1/2	2	15.5
1 1/8	11 13/16	5 1/8	2 3/8	2 3/8	2 1/4	4	1	4 1/8	5	2 1/4	22
1 1/4-1 3/8	13 3/16	5 1/2	2 3/4	2 13/16	2 1/2	4 3/4	1 1/8	4 3/4	5 5/8	2 1/2	32
1 1/2	15 1/8	6	3	3 3/8	3	5 1/4	1 1/4	5 3/8	6 3/8	2 3/4	46
1 5/8	16 1/4	6 1/2	3 3/4	3 3/4	3	5 1/2	1 5/16	5 3/4	6 3/8	3	55
1 3/4-1 7/8	18 1/4	7 1/2	3 3/8	3 3/4	3 1/2	6 3/8	1 5/16	6 1/2	7 3/8	3 1/2	85
2-2 1/8	21 1/2	8 1/2	4 1/4	4	4	7 3/8	1 13/16	7	8 3/8	3 3/4	125
2 1/4-2 3/8	23 1/2	9	4 3/8	4 1/2	4 1/2	8 1/4	2 1/4	7 3/4	10	4 1/4	165
2 1/2-2 5/8	25 1/2	9 3/4	4 3/4	5	5	9 1/4	2 3/8	8 1/2	11	4 3/4	252
2 3/4-2 3/4	27 1/4	11	4 7/8	5 1/4	5 1/4	10 3/4	2 1/2	9	12	5	315
3-3 1/8	29	12	5 1/4	5 3/4	5 3/4	11 1/2	3	9 1/2	12 3/4	5 1/4	380
3 1/4-3 3/8	30 3/4	13	5 3/4	6 1/8	6 1/4	12 1/4	3 1/8	10	13 1/2	5 1/2	435
3 1/2-3 3/4	33 1/4	14	6 1/4	6 3/4	6 3/4	13	3 1/4	10 3/4	14 1/4	6	563
3 3/4-4	36 1/4	15	7	7 3/4	7 1/2	14 1/2	3 1/2	12 1/2	15 1/2	7	785

Larger Sizes Available Upon Request.

5/16" - 2 1/2" in accordance with Federal Specification RR-S-450D, Amendment 1.



Closed Wire Rope Spelter Sockets

Material Specification:

All cast sockets are ASTM A148 steel, grade 90-60.
 All sockets are magnetic particle inspected at critical areas. Forged & cast sockets are proof tested on special order.

Note: This drawing illustrates one groove used on sockets 1/2" & smaller. Sizes 5/16"-1 1/2" have two grooves. Sizes 1 3/4" & larger have three grooves.

Tolerances: Dimensions under 4", ±1/8"; over 4" ±1/4".
 "U", "W", "L", & "N" are minimum dimensions.

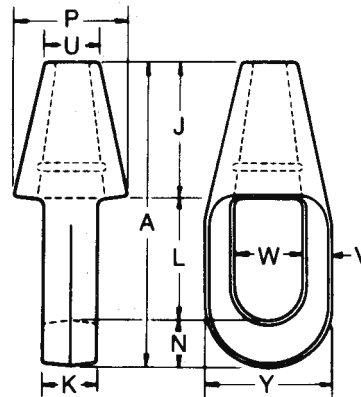

STANDARD CLOSED WIRE ROPE SOCKETS

Meets Federal Specifications RR-S-550.

Rope Diameter	Dimensions In Inches								Weight Each In Pounds
	A	J	K	N	P	V	W	Y	
1/4	4 1/2	2 1/4	1/2	1/2	1 1/16	5/16	13/16	1 1/2	0.7
5/16-3/8	4 7/8	2 1/2	13/16	5/8	1 1/8	3/8	15/16	1 13/16	1.1
7/16-1/2	5 3/8	2 7/8	7/8	13/16	1 1/4	7/8	1 1/8	2	1.5
5/8-5/8	6 3/8	3	1	15/16	2 3/8	3/4	1 1/8	2 5/8	3.0
3/4	7 3/8	3 1/2	1 1/4	1 1/8	2 3/4	15/16	1 5/8	3	4.5
7/8	8 3/8	4	1 1/2	1 1/4	3 1/4	7/8	1 7/8	3 3/8	7
1	9 3/8	4 1/2	1 3/4	1 3/8	3 3/4	15/16	2 1/4	4 1/8	11
1 1/8	11	5	2	1 1/2	4 1/8	1	2 1/2	4 1/2	16
1 1/4-1 3/8	12 1/8	5 1/2	2 1/4	1 5/8	4 3/4	1 1/8	2 3/4	5	22
1 1/2	13 13/16	6	2 1/2	1 15/16	5 1/4	1 1/8	3 3/8	5 3/8	28
1 5/8	15 1/8	6 1/2	2 3/4	2 1/8	5 1/2	1 1/4	3 1/4	5 3/4	36
1 3/4-1 7/8	17 1/4	7 1/2	3	2 3/16	6 3/8	1 1/2	3 13/16	6 3/8	58
2-2 1/8	19 1/2	8 1/2	3 1/4	2 7/16	7 3/8	1 3/8	3 25/32	7 5/8	80
2 1/4-2 3/8	21 3/8	9	3 3/8	2 3/8	8 1/4	1 3/4	4 1/2	8 1/2	106
2 1/2-2 3/4	23 1/2	9 3/4	4	3 3/8	9 1/4	2	5 1/2	9 1/2	140
2 3/4-2 7/8	25 3/8	11	4 1/4	3 3/8	10 3/4	2 1/4	6 1/2	10 3/4	220
3-3 1/8	27	12	5 1/4	3 3/4	11 1/2	2 1/2	6 3/4	11 1/2	275
3 1/4-3 3/8	29 1/4	13	5 3/4	4	12 1/4	2 3/4	7 1/4	12 1/4	315
3 1/2-3 3/4	31	14	6 1/4	4	13	3	7 3/4	13	400
3 3/4-4	33 1/4	15	7	4 1/4	14 1/2	3 3/8	8 1/4	14	540

Larger Sizes Available Upon Request.

5/16" - 2 1/2" in accordance with Federal Specification RR-S-450D, Amendment 1



Turnbuckles

2

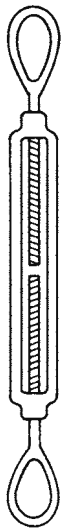

EYE & EYE

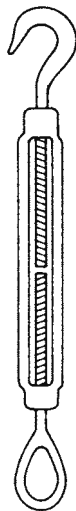

HOOK & EYE

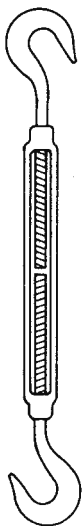

HOOK & HOOK

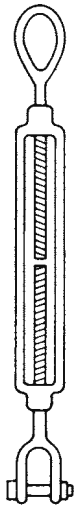

JAW & EYE

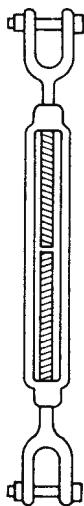

JAW & JAW

When Ordering Be Sure To Specify:

- 1st— Diameter of thread.
- 2nd— Length of take-up.
- 3rd— Self colored or galvanized.
- 4th— The type of end fittings desired.

Meets Federal Specification FF-T-791 (latest revision)

Diameter (A) and Takeup (B) Inches	Average Overall Length in Closed Position Inches	WEIGHT POUNDS EACH		
		With Eyes or Hooks	Jaw and Eye	Jaw and Jaw
¼ X 4	8 ¼	.31	.33	.35
⅝ X 4½	9 ⅝	.50	.53	.58
¾ X 6	11 ¾	.79	.86	.93
½ X 6	13 ⅝	1.42	1.54	1.66
	9	1.83	1.95	2.07
	12	2.01	2.19	2.37
¾ X 6	15 ½	2.61	2.81	3.02
	9	2.81	3.01	3.22
	12	3.12	3.32	3.53
	18	28 ⅛	6.00	6.20
¾ X 6	17 ⅝	3.60	3.87	4.18
	9	4.69	4.98	5.27
	12	5.07	5.36	5.65
	18	29 ⅝	6.21	6.51
⅞ X 12	24 ⅝	8.10	8.75	9.40
	18	9.93	10.60	11.20
1 X 6	20 ⅝	8.75	9.15	9.50
	12	10.40	11.20	12.10
	18	13.20	14.10	14.90
	24	38 ⅝	15.90	16.80
1 ¼ X 12	29 ⅝	19.00	20.50	22.00
	18	23.40	24.90	26.40
	24	41 ⅝	27.80	29.30
1 ½ X 12	32 ⅝	26.10	28.20	30.30
	18	37.50	39.60	41.80
	24	43.10	45.20	47.30
	36	58 ⅝	52.60	54.80
1 ¾ X 18	41 ⅝	45.00	48.80	52.40
	24	52.20	56.00	59.60
2 X 24	51 ⅝	89.80	94.60	100.00
2 ½ X 24	58 ½	140.00	150.00	161.00
2 ¾ X 24	61 ½	194.00	200.00	216.00

Larger sizes available per request.

Lock nuts available per request.

Jaw end fittings sizes ¼" through ⅝" have bolts and nuts.

Jaw end fittings sizes ¾" through 2 ¾" have pins and cotters.

Large jaw sizes available with bolts and nuts upon special request.



Turnbuckles

For sizing information, refer to our website: <http://www.industrialrope.com>

HOOK

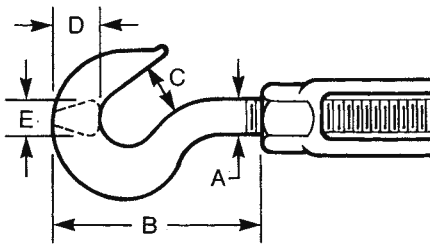

HOOK

DIMENSIONS IN INCHES					Rated Load Pounds
A	B	C	D	E	
1/4	1 1/8	7/16	3/8	1/4	400
5/16	1 29/32	1/2	7/16	5/16	700
3/8	2 3/32	9/16	17/32	3/8	1000
1/2	2 27/32	21/32	11/16	1/2	1500
5/8	3 17/32	27/32	27/32	5/8	2250
3/4	4 5/16	31/32	1	3/4	3000
7/8	5	1 1/8	1 3/16	7/8	4000
1	5 1/16	1 1/4	1 3/8	1	5000
1 1/4	6 29/32	1 1/2	1 1/2	1 1/16	5000
1 1/2	8 1/16	1 7/8	1 3/4	1 5/16	7500

EYE

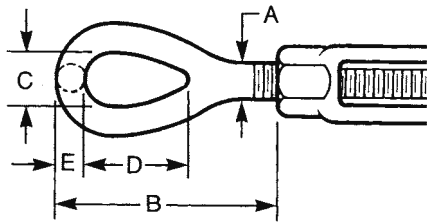

EYE

DIMENSIONS IN INCHES					Rated Load Pounds
A	B	C	D	E	
1/4	1 29/32	1 1/2	25/32	7/32	500
5/16	2 3/16	7/16	15/16	9/32	800
3/8	2 9/16	17/32	1 1/8	1 1/32	7200
1/2	3 3/32	23/32	1 7/16	7/16	2200
5/8	3 3/8	7/8	1 3/4	1/2	3500
3/4	4 1/16	1	2 1/8	5/8	5200
7/8	5 1/4	1 1/4	2 3/8	3/4	7200
1	6 3/8	1 7/16	3	7/8	70000
1 1/4	7 3/4	1 13/16	3 9/16	1 1/8	15200
1 1/2	8 3/8	2 1/8	4 1/8	1 1/4	27400
1 3/4	10	2 3/8	4 11/16	1 1/2	28000
2	12 1/8	2 11/16	5 3/8	1 3/4	37000
2 1/2	13 3/16	3 1/8	6 1/2	2	60000
2 3/4	15	3 1/4	7	2 1/4	75000

JAW

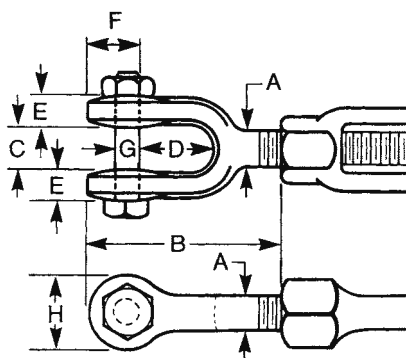

JAW

DIMENSIONS IN INCHES								Rated Load Pounds
A	B	C	D	E	F	G	H	
1/4	1 3/8	13/32	5/8	9/32	1/2	1/4	5/8	500
5/16	2	15/32	7/8	9/32	1/2	1/4	1 1/16	800
3/8	2 3/16	1/2	7/8	5/16	19/32	5/16	13/16	1200
1/2	2 3/4	5/8	1 1/16	13/32	3/4	3/8	1	2200
5/8	3 1/2	3/4	1 1/16	1/2	1 1/2	1/2	1 1/8	3500
3/4	4 1/8	15/16	1 1/2	9/16	1 3/32	5/8	1 3/8	5200
7/8	4 27/32	1 1/8	1 3/4	11/16	1 15/32	3/4	1 7/8	7200
1	5 17/32	1 3/16	2 1/16	25/32	1 21/32	7/8	2 1/8	10000
1 1/4	7 3/16	1 3/4	2 13/16	1	2 3/32	1 1/8	2 3/8	15200
1 1/2	7 7/8	2 1/16	2 13/16	1 1/16	2 15/32	1 3/8	3 1/8	21400
1 3/4	9 3/8	2 3/8	3 3/8	1 1/4	2 29/32	1 3/8	3 1/2	28000
2	10 7/8	2 1/2	3 11/16	1 1/16	3 17/32	2	4 3/16	37000
2 1/2	13 11/16	2 7/8	4 7/16	1 1/16	4 3/8	2 1/4	5 3/8	60000
2 3/4	15	3 1/2	4 3/8	1 3/8	5 3/8	2 3/4	6 1/8	75000

Proof load twice rated load

*Ultimate load five times rated load

Forged Eye Bolts



Fatigue Rated

G-291

2



- Forged Steel - Quenched and Tempered.
- Fatigue rated at 1-1/2 times the Working Load Limit at 20,000 cycles.
- All Bolts Hot Dip galvanized after threading (UNC).
- Furnished with standard Hot Dip galvanized hex nuts.
- Recommended for in-line pull.
- Meets or exceeds all requirements of ASME B30.26 including identification, ductility, design factor, proof load and temperature requirements. Importantly, these bolts meet other critical performance requirements including fatigue life, impact properties and material traceability, not addressed by ASME B30.26.

G-291 Regular Nut Eye Bolts

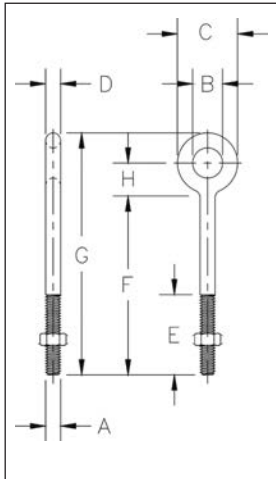

Shank Dia. & Length (in.)	G-291 Stock No.	Working Load Limit (lbs.)*	Weight Per 100 (lbs.)	Dimensions (in.)							
				A	B	C	D	E	F	G	H
1/4 x 2	1043230	650	8.20	.25	.50	1.00	.25	1.50	2.00	3.06	.56
1/4 x 4	1043258	650	11.70	.25	.50	1.00	.25	2.50	4.00	5.06	.56
5/16 x 2-1/4	1043276	1200	13.30	.31	.62	1.25	.31	1.50	2.25	3.56	.69
5/16 x 4-1/4	1043294	1200	25.00	.31	.62	1.25	.31	2.50	4.25	5.56	.69
3/8 x 2-1/2	1043310	1550	23.30	.38	.75	1.50	.38	1.50	2.50	4.12	.88
3/8 x 4-1/2	1043338	1550	29.50	.38	.75	1.50	.38	2.50	4.50	6.12	.88
3/8 x 6	1043356	1550	35.20	.38	.75	1.50	.38	2.50	6.00	7.62	.88
1/2 x 3-1/4	1043374	2600	50.30	.50	1.00	2.00	.50	1.50	3.25	5.38	1.12
1/2 x 6	1043392	2600	66.10	.50	1.00	2.00	.50	3.00	6.00	8.12	1.12
1/2 x 8	1043418	2600	82.00	.50	1.00	2.00	.50	3.00	8.00	10.12	1.12
1/2 x 10	1043436	2600	88.00	.50	1.00	2.00	.50	3.00	10.00	12.12	1.12
1/2 x 12	1043454	2600	114.20	.50	1.00	2.00	.50	3.00	12.00	14.12	1.12
5/8 x 4	1043472	5200	103.10	.62	1.25	2.50	.62	2.00	4.00	6.69	1.44
5/8 x 6	1043490	5200	118.20	.62	1.25	2.50	.62	3.00	6.00	8.69	1.44
5/8 x 8	1043515	5200	135.10	.62	1.25	2.50	.62	3.00	8.00	10.69	1.44
5/8 x 10	1043533	5200	153.60	.62	1.25	2.50	.62	3.00	10.00	12.69	1.44
5/8 x 12	1043551	5200	167.10	.62	1.25	2.50	.62	4.00	12.00	14.69	1.44
3/4 x 4-1/2	1043579	7200	168.60	.75	1.50	3.00	.75	2.00	4.50	7.69	1.69
3/4 x 6	1043597	7200	184.50	.75	1.50	3.00	.75	3.00	6.00	9.19	1.69
3/4 x 8	1043613	7200	207.90	.75	1.50	3.00	.75	3.00	8.00	11.19	1.69
3/4 x 10	1043631	7200	235.00	.75	1.50	3.00	.75	3.00	10.00	13.19	1.69
3/4 x 12	1043659	7200	257.50	.75	1.50	3.00	.75	4.00	12.00	15.19	1.69
3/4 x 15	1043677	7200	298.00	.75	1.50	3.00	.75	5.00	15.00	18.19	1.69
7/8 x 5	1043695	10600	270.00	.88	1.75	3.50	.88	2.50	5.00	8.75	2.00
7/8 x 8	1043711	10600	308.00	.88	1.75	3.50	.88	4.00	8.00	11.75	2.00
7/8 x 12	1043739	10600	400.00	.88	1.75	3.50	.88	4.00	12.00	15.75	2.00
1 x 6	1043757	13300	421.00	1.00	2.00	4.00	1.00	3.00	6.00	10.31	2.31
1 x 9	1043775	13300	468.50	1.00	2.00	4.00	1.00	4.00	9.00	13.31	2.31
1 x 12	1043793	13300	540.00	1.00	2.00	4.00	1.00	4.00	12.00	16.31	2.31
1 x 18	1043819	13300	650.00	1.00	2.00	4.00	1.00	7.00	18.00	22.31	2.31
1-1/4 x 8	1043837	21000	750.00	1.25	2.50	5.00	1.25	4.00	8.00	13.38	2.88
1-1/4 x 12	1043855	21000	900.00	1.25	2.50	5.00	1.25	4.00	12.00	17.38	2.88
1-1/4 x 20	1043873	21000	1210.00	1.25	2.50	5.00	1.25	6.00	20.00	25.38	2.88

*Ultimate Load is 5 times the Working Load Limit. Working Load Limit shown is for in-line pull. Maximum Proof Load is 2 times the Working Load Limit.



Forged Eye Bolts



G-277



- Forged Steel - Quenched and Tempered.
- Fatigue rated at 1-1/2 times the Working Load Limit at 20,000 cycles.
- Working Load Limits shown are for in-line pull.
- Meets or exceeds all requirements of ASME B30.26 including identification, ductility, design factor, proof load and temperature requirements. Importantly, these bolts meet other critical performance requirements including fatigue life, impact properties and material traceability, not addressed by ASME B30.26.
- All Bolts Hot Dip galvanized after threading (UNC).
- Furnished with standard Hot Dip galvanized, heavy hex nuts.

2

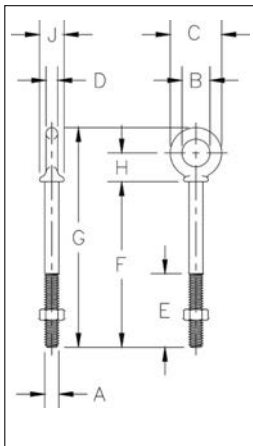

G-277 Shoulder Nut Eye Bolts

Shank Dia. & Length (in.)	G-277 Stock No.	Working Load Limit (lbs.)*	Weight Each Per 100 (lbs.)	Dimensions (in.)									
				A	B	C	D	E	F	G	H	J	
1/4 x 2	1045014	650	6.60	.25	.50	.88	.19	1.50	2.00	2.94	.50	.47	
1/4 x 4	1045032	650	9.10	.25	.50	.88	.19	2.50	4.00	4.94	.50	.47	
5/16 x 2-1/4	1045050	1200	12.50	.31	.62	1.12	.25	1.50	2.25	3.50	.69	.56	
5/16 x 4-1/4	1045078	1200	18.80	.31	.62	1.12	.25	2.50	4.25	5.50	.69	.56	
3/8 x 2-1/2	1045096	1550	21.40	.38	.75	1.38	.31	1.50	2.50	3.97	.78	.66	
3/8 x 4-1/2	1045112	1550	25.30	.38	.75	1.38	.31	2.50	4.50	5.97	.78	.66	
1/2 x 3-1/4	1045130	2600	42.60	.50	1.00	1.75	.38	1.50	3.25	5.12	1.00	.91	
1/2 x 6	1045158	2600	56.80	.50	1.00	1.75	.38	3.00	6.00	7.88	1.00	.91	
5/8 x 4	1045176	5200	68.60	.62	1.25	2.25	.50	2.00	4.00	6.44	1.31	1.12	
5/8 x 6	1045194	5200	102.40	.62	1.25	2.25	.50	3.00	6.00	8.44	1.31	1.12	
3/4 x 4-1/2	1045210	7200	144.50	.75	1.50	2.75	.62	2.00	4.50	7.44	1.56	1.38	
3/4 x 6	1045238	7200	167.50	.75	1.50	2.75	.62	3.00	6.00	8.94	1.56	1.38	
7/8 x 5	1045256	10600	225.00	.88	1.75	3.25	.75	2.50	5.00	8.46	1.84	1.56	
1 x 6	1045292	13300	366.30	1.00	2.00	3.75	.88	3.00	6.00	9.97	2.09	1.81	
1 x 9	1045318	13300	422.50	1.00	2.00	3.75	.88	4.00	9.00	12.97	2.09	1.81	
1-1/4 x 8	1045336	21000	650.00	1.25	2.50	4.50	1.00	4.00	8.00	12.72	2.47	2.28	
1-1/4 x 12	1045354	21000	795.00	1.25	2.50	4.50	1.00	4.00	12.00	16.72	2.47	2.28	
1-1/2 x 15	1045372	24000	1425.00	1.50	3.00	5.50	1.25	6.00	15.00	20.75	3.00	2.75	

*Ultimate Load is 5 times the Working Load Limit. Maximum Proof Load is 2 times the Working Load Limit.



G-275



- Forged Steel — Quenched and Tempered.
- Hot Dip galvanized.

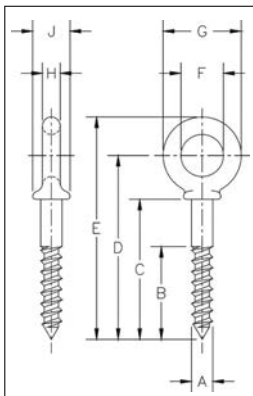

G-275 Screw Eye Bolts

Shank Dia. & Length (in.)	G-275 Stock No.	Weight Per 100 (lbs.)	Dimensions (in)									
			A	B	C	D	E	F	G	H	J	
1/4 x 2	1046111	4.30	.25	1.50	2.00	2.50	2.94	.50	.88	.19	.47	
5/16 x 2-1/4	1046139	9.90	.31	1.69	2.25	2.94	3.50	.63	1.13	.25	.56	
3/8 x 2-1/2	1046157	18.88	.38	1.88	2.50	3.28	3.97	.75	1.38	.31	.66	
1/2 x 3-1/4	1046175	37.50	.50	2.44	3.25	4.25	5.12	1.00	1.75	.38	.91	
5/8 x 4	1046193	85.50	.63	3.00	4.00	5.31	6.44	1.25	2.25	.50	1.12	



Crosby® Eye Hooks

Load Rated Fatigue Rated "QT" QUENCHED & TEMPERED



2

S-320 & S-320N EYE HOOKS



All Crosby 320 Eye Hoist Hooks incorporate the following features:

- The most complete line of Eye hoist hooks.
- Available in carbon steel and alloy steel.
- Designed with a 5:1 Design Factor for (Carbon Steel); 4.5:1 Design Factor for 30t - 60t(Alloy Steel).
- Eye hooks are load rated.
- Proper design, careful forging and precision controlled quenched and tempering give maximum strength without excessive weight and bulk.
- Every Crosby Eye Hook has a pre-drilled cam which can be equipped with a latch. Even years after purchase of the original hook, latch assemblies can be added.
- Chemical analysis and tensile tests performed on each PIC to verify chemistry and mechanical properties.
- Type Approval and certification in accordance with ABS 2007 Steel Vessel Rules 1-1-17.7, and ABS Guide for Certification of Cranes.
- Hoist hooks incorporate two types of strategically placed markings forged into the product which address two (2) QUIC-CHECK® features:
 - Deformation Indicators and Angle Indicators

The following additional features have been incorporated in the new Crosby S-320N Eye Hoist Hooks. (Sizes 3/4 metric ton Carbon through 22 metric ton Alloy.)

- Metric Rated at 5:1 Design Factor for (Carbon Steel); 5:1 Design Factor for 1t - 22t (Alloy Steel).
- Can be proof tested to 2 times the working Load Limit.
- Low profile hook tip.
- New integrated latch (S-4320) meets the World class standard for lifting.
 - Heavy duty stamped latch interlocks with the hook tip.
 - High cycle, long life spring.
 - When secured with proper cotter pin through the hole in the tip of hook, meets the intent of OSHA Rule 1926.1431(g) and 1926.1501(g) for personnel hoisting.
- Fatigue rated at 1-1/2 times the Working Load Limit at 20,000 cycles.

Working Load Limit (t)		Hook ID Code	Eye Hook Stock No.			Weight Each (lbs.)	Replacement Latch Kits		
Carbon	Alloy		Carbon S-320C S-320CN S.C.	Carbon G-320CN Galv.	Alloy S-320A S-320AN S.C.		S-4320 Stock No.	PL Stock No.	SS-4055 Stock No.
3/4	1	†D	1022200	1022208	1022375	.61	1096325	-	-
1	1-1/2	†F	1022211	1022219	1022386	.89	1096374	-	-
1-1/2	2	†G	1022222	1022230	1022397	1.44	1096421	-	-
2	3	†H	1022233	1022241	1022406	2.07	1096468	-	-
3	5	†I	1022244	1022249	1022419	4.30	1096515	1092000	-
5	7	†J	1022255	1022262	1022430	8.30	1096562	1092001	-
7-1/2	11	†K	1022264	1022274	1022441	15.00	1096609	1092002	-
10	15	†L	1022277	1022285	1022452	20.77	1096657	1092003	-
15	22	†N	1022288	1022296	1022465	39.50	1096704	1092004	-
20	30	O	1023289	-	1023546	60.00	-	1093716	1090161
25	37	P	1023305	-	1023564	105.00	-	1093717	1090189
30	45	S	1023323	-	1023582	148.00	-	1093718	1090189
40	60	T	1023341	-	1023608	228.00	-	1093719	1090205

*Eye Hooks (3/4 TC - 22TA), Proof load is 2 times Working Load Limit. Eye Hooks (20 TC - 60TA). All carbon hooks-average straightening load (ultimate load) is 5 times Working Load Limit. Alloy eye hooks 1 ton through 22 ton-average straightening load (ultimate load) is 5 times Working Load Limit. Alloy eye hooks 30 tons through 60 tons-average straightening load (ultimate load) is 4.5 times Working Load Limit.

† New 320N style hook.



Crosby® Eye Hooks



S-320 & S-320N EYE HOOKS



- Hoist hooks incorporate markings forged into the product which address two (2) QUIC-CHECK® features.
 - **Deformation Indicators** -- Two strategically placed marks, one just below the shank or eye and the other on the hook tip, which allows for a QUIC-CHECK® measurement to determine if the throat opening has changed, thus indicating abuse or overload. To check, use a measuring device (i.e. tape measure) to measure the distance between the marks. The marks should align to either an inch or half-inch increment on the measuring device. If the measurement does not meet this criteria, the hook should be inspected further for possible damage.
 - **Angle Indicators** -- Indicates the maximum included angle which is allowed between two (2) sling legs in the hook. These indicators also provide the opportunity to approximate other included angles between two sling legs.

2

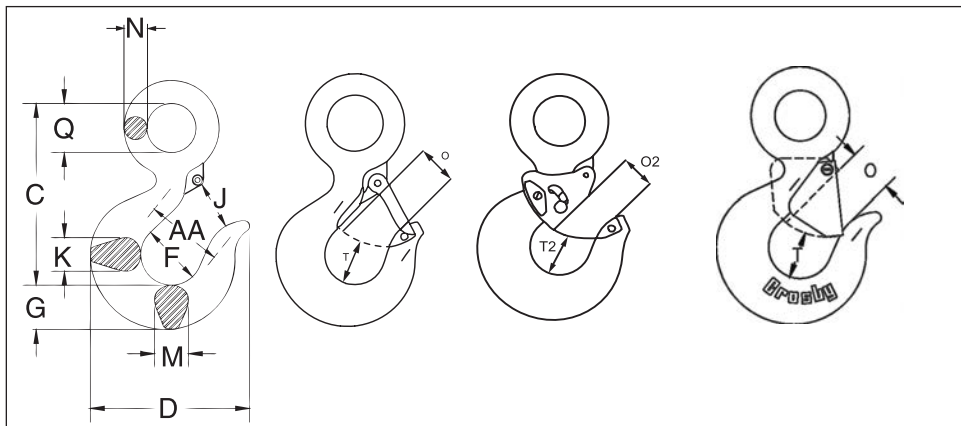

Hook ID Code*	Dimensions (in.)													
	C	D	F	G	J	K	M	N	O †	O2 ††	Q	T †	T2 ††	AA
D	3.34	2.83	1.25	.73	.90	.63	.63	.36	.89	-	.75	.87	-	1.50
F	3.81	3.11	1.38	.84	.93	.71	.71	.42	.91	-	.91	.98	-	2.00
G	4.14	3.53	1.50	1.00	1.00	.88	.88	.55	1.00	-	1.13	1.03	-	2.00
H	4.69	3.97	1.63	1.13	1.13	.94	.94	.58	1.09	-	1.25	1.16	-	2.00
I	5.77	4.81	2.00	1.44	1.47	1.31	1.31	.72	1.36	1.00	1.56	1.53	1.50	2.50
J	7.37	6.27	2.50	1.81	1.75	1.66	1.66	.90	1.61	1.31	2.00	1.96	1.88	3.00
K	9.07	7.45	3.00	2.25	2.29	1.88	1.63	1.11	2.08	1.81	2.44	2.47	2.25	4.00
L	10.08	8.30	3.25	2.59	2.50	2.19	1.94	1.27	2.27	2.00	2.84	2.62	2.31	4.00
N	12.53	10.30	4.25	3.00	3.30	2.69	2.38	1.56	3.02	2.75	3.50	2.83	2.56	5.00
O	14.06	13.62	5.00	3.62	4.00	3.00	3.00	1.75	3.25	-	3.50	3.44	-	6.50
P	18.19	14.06	5.38	4.56	4.25	3.75	3.19	2.00	3.00	-	4.50	3.88	-	7.00
S	20.12	15.44	6.00	5.06	4.75	4.50	3.25	2.18	3.38	-	4.94	4.75	-	8.00
T	23.72	18.50	7.00	6.00	5.75	5.50	3.91	2.53	4.12	-	5.69	5.69	-	10.00

*Eye Hooks (3/4 TC-22TA), Proof load is 2 times Working Load Limit. Eye Hooks (20 TC-60TA). All carbon hooks - average straightening load (ultimate load) is 5 times Working Load Limit. Alloy eye hooks 1t through 22t - average straightening load (ultimate load) is 4.5 times Working Load Limit. Alloy eye hooks 30t through 60t - average straightening load (ultimate load) is 4.5 times Working Load Limit.

† 3/4tC - 22tA dimensions shown are for S-4320 Latch Kits. Dimensions for sizes 20t carbon and larger are for PL Latch Kits.

†† Dimensions are for PL-N latch kits.



Crosby® Swivel Hooks

Load Rated Fatigue Rated **TA** TYPE APPROVED **QUIC-CHECK®**

S-322CN / S-322AN



(L-322AN shown)

- Forged - Quenched and Tempered.
- Swivel hooks are load rated.
- Proper design, careful forging, and precision controlled quench and tempering gives maximum strength without excessive weight and bulk.
- Low profile hook tip designed to utilize Crosby S-4320 or PL-N latch kit. Simply purchase the latch assemblies listed and shown on pages 119 - 121. Even years after purchase of the original hook, latch assemblies can be added.
- Hoist hooks incorporate markings forged into the product which address two (2) QUIC-CHECK® features:
 - **Deformation Indicators** -- Two strategically placed marks, one just below the shank or eye and the other on the hook tip, which allows for a QUIC-CHECK® measurement to determine if the throat opening has changed, thus indicating abuse or overload.
 - **Angle Indicators** — Indicates the maximum included angle which is allowed between two (2) sling legs in the hook. These indicators also provide the opportunity to approximate other included angles between two sling legs.
- Type Approval and certification in accordance with ABS 2007 Steel Vessel Rules 1-1-17.7, and ABS Guide for Certification of Cranes.

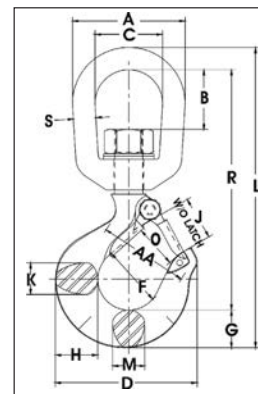

This hook is a positioning device and is not intended to rotate under load. For swivel hooks designed to rotate under load, see pages 103, 105, 113, 114, 122-125. Use in corrosive environment requires shank and nut inspection in accordance with ASME B30.10-1.10.4 (b)(5)(c) 2009.

Working Load Limit (t)*		S-322 CN Stock No.	S-322 AN Stock No.	Weight Each (lbs.)	Dimensions (in.)															Rep. Latch Stock No.
Carbon	Alloy				A	B	C	D	F	G	H	J	K	L	M	O †	R	S	AA	
3/4	1	1048600	1048804	.75	2.00	.82	1.25	2.86	1.25	.73	.81	.93	.63	5.66	.63	.89	4.55	.38	1.50	1096325
1	1-1/2	1048609	1048813	1.25	2.50	1.31	1.50	3.15	1.38	.84	.94	.97	.71	6.71	.71	.91	5.37	.50	2.00	1096374
1-1/2	2	1048618	1048822	2.25	3.00	1.50	1.75	3.59	1.50	1.00	1.16	1.06	.88	7.75	.88	1.00	6.12	.63	2.00	1096421
2	3	1048627	1048831	2.30	3.00	1.50	1.75	4.00	1.62	1.13	1.31	1.19	.94	8.25	.94	1.09	6.50	.63	2.00	1096468
3	5	1048636	1048837	4.96	3.50	1.64	2.00	4.84	2.00	1.44	1.63	1.50	1.31	9.69	1.13	1.36	7.50	.75	2.50	1096515
5	7	1048645	1048854	10.29	4.56	2.29	2.50	6.28	2.50	1.81	2.06	1.78	1.66	12.47	1.44	1.61	9.63	1.00	3.00	1096562
7-1/2	11	1048654	1048865	19.40	5.00	2.53	2.75	7.54	3.00	2.25	2.63	2.41	1.88	14.75	1.63	2.08	11.37	1.13	4.00	1096609
10	15	1048663	1048877	23.25	5.62	2.48	3.12	8.34	3.25	2.59	2.94	2.62	2.19	16.40	1.94	2.27	12.25	1.25	4.00	1096657
15	22	1048672	1048886	47.00	7.10	3.76	4.10	10.34	4.25	3.00	3.50	3.41	2.69	21.34	2.38	3.02	16.71	1.50	5.00	1096704
-	30	-	1025688	70.50	7.10	3.76	4.10	13.62	5.00	3.61	4.63	4.00	3.00	23.25	3.00	3.25	18.01	1.50	6.50	1093716

*NOTE: Carbon swivel hooks .75tC-15tC: proof load is 2 times working load limit. Designed with a 5 to 1 design factor.

Alloy swivel hooks 1tA-22tA: proof load is 2.5 times working load limit. Designed with a 4.5 to 1 design factor.

Alloy swivel hook 30tA: proof load is 2 times working load limit. Designed with a 4 to 1 design factor.

† Dimensions for hooks 3/4 ton carbon thru 22t alloy are for S-4320 latch kits. Dimensions for hooks 31.5t alloy are for PL latch kit.

Working Load Limit (t)*		L-322 CN Stock No.	L-322 AN Stock No.	Weight Each (lbs.)	Dimensions (in.)															Rep. Latch Stock No.
Carbon	Alloy				A	B	C	D	F	G	H	J	K	L	M	O †	R	S	AA	
3/4	1	1048603	1048807	.75	2.00	.82	1.25	2.86	1.25	.73	.81	.93	.63	5.66	.63	.89	4.55	.38	1.50	1096325
1	1-1/2	1048612	1048816	1.25	2.50	1.31	1.50	3.15	1.38	.84	.94	.97	.71	6.71	.71	.91	5.37	.50	2.00	1096374
1-1/2	2	1048621	1048825	2.25	3.00	1.50	1.75	3.59	1.50	1.00	1.16	1.06	.88	7.75	.88	1.00	6.12	.63	2.00	1096421
2	3	1048630	1048834	2.30	3.00	1.50	1.75	4.00	1.62	1.13	1.31	1.19	.94	8.25	.94	1.09	6.50	.63	2.00	1096468
3	5	1048639	1048840	4.96	3.50	1.64	2.00	4.84	2.00	1.44	1.63	1.50	1.31	9.69	1.13	1.36	7.50	.75	2.50	1096515
5	7	1048648	1048859	10.29	4.56	2.29	2.50	6.28	2.50	1.81	2.06	1.78	1.66	12.47	1.44	1.61	9.63	1.00	3.00	1096562
7-1/2	11	1048657	1048868	19.40	5.00	2.53	2.75	7.54	3.00	2.25	2.63	2.41	1.88	14.75	1.63	2.08	11.37	1.13	4.00	1096609
10	15	1048666	1048880	23.25	5.62	2.48	3.12	8.34	3.25	2.59	2.94	2.62	2.19	16.40	1.94	2.27	12.25	1.25	4.00	1096657
15	22	1048675	1048889	47.00	7.10	3.76	4.10	10.34	4.25	3.00	3.50	3.41	2.69	21.34	2.38	3.02	16.71	1.50	5.00	1096704
-	30	-	-	70.50	7.10	3.76	4.10	13.62	5.00	3.61	4.63	4.00	3.00	23.25	3.00	3.25	18.01	1.50	6.50	1093716

*NOTE: Carbon swivel hooks .75tC-15tC: proof load is 2 times working load limit. Designed with a 5 to 1 design factor.

Alloy swivel hooks 1A-22A: proof load is 2.5 times working load limit. Designed with a 4.5 to 1 design factor.

Alloy swivel hook 30tA: proof load is 2 times working load limit. Designed with a 4 to 1 design factor.

† Dimensions for hooks 3/4 ton carbon thru 22t alloy are for S-4320 latch kits. Dimensions for hooks 31.5t alloy are for PL latch kit.



Crosby® Swivel Hooks



2

S-3322B SWIVEL HOOKS WITH BEARING



New anti-friction bearing design allows hook to rotate freely under load.

- Capacities ranging from 2 through 15 metric tonnes.
- Forged - Quenched and Tempered.
- Proper design, careful forging, and precision controlled quench and tempering gives maximum strength without excessive weight and bulk.
- Low profile hook tip designed to utilize Crosby S-4320 or PL-N latch kit. Simply purchase the latch assemblies listed and shown on pages 119 - 121. Even years after purchase of the original hook, latch assemblies can be added.
- S-3322 hooks incorporate markings forged into the product which address two (2) QUIC-CHECK® features:
 - **Deformation Indicators** — Two strategically placed marks, one just below the shank and eye and the other on the hook tip, which allows for a QUIC-CHECK® measurement to determine if the throat opening has changed, thus indicating abuse or overload.
 - **Angle Indicators** — Indicates the maximum included angle which is allowed between two (2) sling legs in the hook. These indicators also provide the opportunity to approximate other included angles between two sling legs.

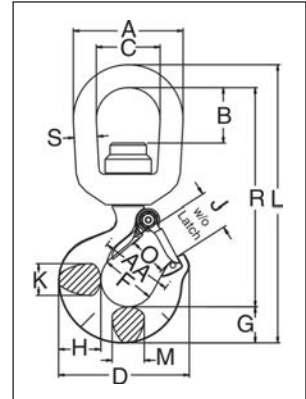

For other swivel hooks designed to rotate under load, see pages 115, 117, 125, 126, 134-137. Use in corrosive environment requires shank and nut inspection in accordance with ASME B30.10-1.10.4 (b)(5)(c) 2009.

Working Load Limit (t)	S-3322B Stock No.	L-3322B Stock No.†	Weight Each (lbs.)	Dimensions (in.)															Rep. Latch Stock No.
				A	B	C	D	F	G	H	J	K	L	M	O	R	S	AA	
2	1028605	1028609	2.5	3.00	1.50	1.75	3.59	1.50	1.00	1.16	1.06	.88	7.64	.88	1.00	6.01	.63	2.00	1096421
3	1028614	1028618	3.8	3.50	1.56	2.00	4.00	1.62	1.13	1.31	1.19	.94	8.60	.94	1.09	6.72	.75	2.00	1096468
5	1028623	1028627	7.0	4.00	1.56	2.25	4.84	2.00	1.44	1.63	1.50	1.31	10.32	1.13	1.36	8.00	.88	2.50	1096515
7	1028632	1028636	14.0	5.00	1.94	2.75	6.27	2.50	1.81	2.06	1.78	1.66	12.84	1.44	1.61	9.90	1.13	3.00	1096562
11	1028641	1028645	22.3	5.62	2.05	3.12	7.54	3.00	2.25	2.63	2.41	1.88	15.24	1.63	2.08	11.74	1.25	4.00	1096609
15	1028650	1028654	36.0	7.12	3.62	4.10	8.33	3.25	2.59	2.94	2.62	2.19	18.64	1.94	2.27	14.41	1.50	4.00	1096657

*NOTE: Proofload is 2.5 times working load limit. Designed with a 4.5 to 1 design factor.
 † Supplied with latch attached.



Crosby® SHUR-LOC® Hooks

Fatigue Rated



Crosby 3/10™
S-1316



All SHUR-LOC® hooks have the following features:

- Forged Alloy Steel - Quenched and Tempered.
- Recessed trigger design is flush with the hook body, protecting the trigger from potential damage.
 - Easy to operate with enlarged thumb access.
- Positive Lock Latch is Self-Locking when hook is loaded.
- The SHUR-LOC® hook, if properly installed and locked, can be used for personnel lifting applications and meets the intent of OSHA Rule 1926.1431(g)(1)(i)(A) and 1926.1501(g)(4)(iv)(B).

Eye Style incorporates these added features:

- Individually Proof Tested to 2-1/2 times the 4:1 Working Load Limit with certification.
- Fatigue rated at 1-1/2 times the Working Load Limit at 20,000 cycles.
- 25% stronger than Grade 80.
- Suitable for use with Grade 100 and Grade 80 chain.
- Designed with "Engineered Flat" to connect to S-1325 chain coupler.

S-1318A

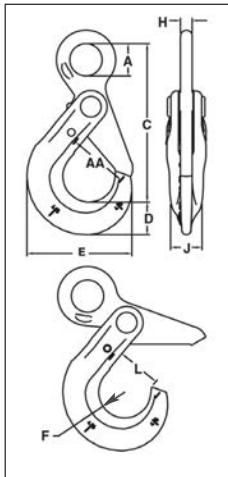

SHUR-LOC® Hook Series with Positive Locking Latch S-1316 Eye Hook

Chain Size		Working Load Limit (lbs.)*	Wire Rope XXIP IWRC Mechanical Splice		S-1316 Stock No.	Weight Each (lbs.)	Dimensions (in.)								
(in.)	(mm)		Size (in.)	Working Load Limit (lbs.) 5:1			A	C	D	E	F	H	J	L	AA
-	6	3200	5/16	2200	1022896	.85	.78	3.95	.79	2.60	.67	.31	.63	1.14	1.50
1/4-5/16	7-8	5700	7/16	4200	1022914	1.80	1.08	5.31	1.10	3.50	.87	.39	.81	1.48	2.00
3/8	10	8800	1/2	5600	1022923	3.40	1.30	6.57	1.17	4.39	1.10	.51	.94	1.83	2.50
1/2	13	15000	3/4	12400	1022932	6.00	1.65	8.23	1.67	5.45	1.26	.67	1.16	2.22	3.00
5/8	16	22600	7/8	16600	1022941	15.1	2.20	10.06	2.04	6.56	1.50	.87	1.50	2.65	3.50
3/4	18-20	35300	1	22000	1022942	19.0	2.60	10.77	2.22	7.76	2.01	.87	2.03	3.52	-
7/8	22	42700	1-1/8	26500	1022943	28.0	2.87	12.49	2.45	8.75	2.27	.98	2.20	3.83	-
1	26	59700	-	-	1022944	49.5	3.15	14.60	3.21	9.87	2.46	1.26	2.68	4.09	-

* Minimum Ultimate Load is 4 times the Working Load Limit.

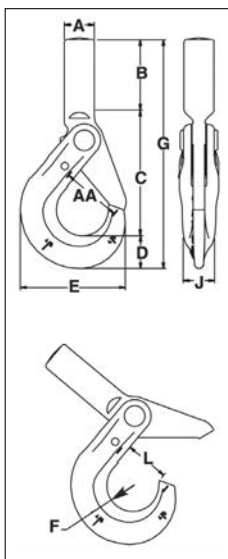

S-1318A SHUR-LOC® Shank Hooks

Chain Size		S-1318A Stock No.	Frame code	Grade 100 Alloy Chain Working Load Limit (lbs.)*	Dimensions (in.)										Weight Each (lbs.)
(in.)	(mm)				A†	B	C	D	E	F	G	J	L	AA	
-	6	1098200	D	3200	.79	2.16	3.31	.79	2.60	.67	6.26	.63	1.16	1.50	1.00
1/4-5/16	7-8	1098209	G	5700	1.00	2.40	4.16	1.10	3.51	.87	7.66	.81	1.48	2.00	1.99
3/8	10	1098218	H	8800	1.14	2.95	5.14	1.17	4.39	1.10	9.26	.94	1.83	2.50	3.56
1/2	13	1098227	I	15000	1.34	3.35	6.31	1.67	5.49	1.26	11.33	1.16	2.22	3.00	7.00
5/8	16	1098236	J	22600	1.63	3.94	7.28	2.04	6.55	1.50	13.26	1.50	2.65	3.50	16.00

* Ultimate Load is 4 times the Working Load Limit based on Grade 100 chain.

† Dimension before machining (as forged).



Crosby® SHUR-LOC® Hooks

Fatigue Rated **QT** QUIC-CHECK® Crosby 8/10™



S-1326

- Forged Alloy Steel - Quenched and Tempered.
- Individually Proof Tested at 2-1/2 times the 4:1 Working Load Limit with certification.
- Recessed trigger design is flush with the hook body, protecting the trigger from potential damage.
 - Easy to operate with enlarged thumb access.
- Positive Lock Latch is Self-Locking when hook is loaded.
- Rated for both Wire Rope and use with Grade 80/100 Chain.
- G-414 Heavy Thimble should be used with wire rope slings.
- Trigger repair Kit available (S-4316). Consists of spring, roll pin and trigger.
- S-13326 Swivel Hook utilizes anti-friction bearing design which allows hook to rotate freely under load.
- Fatigue rated.
- The SHUR-LOC® hook, if properly installed and locked, can be used for personnel lifting applications and meets the intent of OSHA Rule 1926.1431(g)(1)(i)(A) and 1926.1501(g)(4)(iv)(B).
- "Look for the Platinum Color – Crosby Grade 100 Alloy Products".



S-13326

2

Use in corrosive environment requires shank and nut inspection in accordance with ASME B 30.10-1.10.4 (b)(5)(c) 2009.

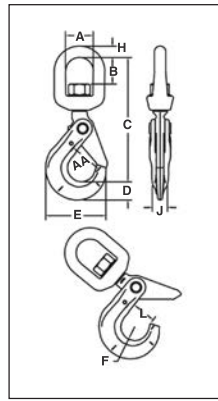

S-1326 SHUR-LOC® Swivel Hooks

- Suitable for infrequent, non-continuous rotation under load.

Chain Size		Grade 100 Alloy Chain Working Load Limit (lbs.) 4:1*	Wire Rope XXIP IWRC Mechanical Splice Working Load Limit (lbs.) 5:1*	S-1326 Stock No.	Weight Each (lbs.)	Dimensions (in.)										
(in.)	(mm)					A	B	C	D	E	F	H	J	L	AA	
-	6	3200	2560	1004304	1.26	1.50	1.32	6.13	.79	2.60	.67	.50	.63	1.13	1.50	
1/4-5/16	7-8	5700	4560	1004313	2.62	1.75	1.59	7.60	1.10	3.50	.87	.63	.81	1.38	2.00	
3/8	10	8800	7040	1004322	4.70	2.00	1.73	8.83	1.17	4.39	1.10	.75	.94	1.75	2.50	
1/2	13	15000	12000	1004331	8.64	2.50	2.38	11.20	1.67	5.45	1.26	1.00	1.16	2.11	3.00	
5/8	16	22600	18000	1004340	17.00	2.75	2.53	12.90	2.05	6.56	1.50	1.13	1.50	2.49	3.50	
3/4	18-20	35300	28240	1004349	24.00	2.83	2.52	14.10	2.22	7.76	2.01	1.10	2.03	3.52	5.00	
7/8	22	44100	35280	1004358	29.00	3.44	3.19	16.40	2.45	8.75	2.26	1.30	2.20	3.83	6.00	

* Ultimate Load is 4 times the Working Load Limit.

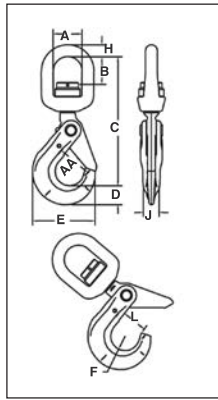

S-13326 SHUR-LOC® Swivel Hooks with Bearing

- Suitable for frequent rotation under load.

Chain Size		Grade 100 Alloy Chain Working Load Limit (lbs.) 4:1*	Wire Rope XXIP IWRC Mechanical Splice Working Load Limit (lbs.) 5:1*	S-13326 Stock No.	Weight Each (lbs.)	Dimensions (in.)										
(in.)	(mm)					A	B	C	D	E	F	H	J	L	AA	
-	6	3200	2560	1004404	1.50	1.50	1.14	6.17	.79	2.60	.67	.50	.63	1.13	1.50	
1/4-5/16	7-8	5700	4560	1004413	3.10	1.75	1.52	7.54	1.10	3.50	.87	.63	.81	1.44	2.00	
3/8	10	8800	7040	1004422	5.26	2.00	1.61	8.88	1.16	4.35	1.10	.75	.94	1.83	2.50	
1/2	13	15000	12000	1004431	11.22	2.50	2.03	11.11	1.66	5.45	1.26	1.00	1.16	2.19	3.00	
5/8	16	22600	18000	1004440	17.32	2.75	1.98	12.90	2.05	6.56	1.50	1.13	1.50	2.61	3.50	

* Ultimate Load is 4 times the Working Load Limit.



Crosby® Forged Hooks

BH-313



- Wide range of sizes available: 1-10 Metric Ton capacity.
- Forged Alloy Steel.
- Designed for attachment to mobile lifting equipment to provide a pick point for easy sling attachment.
- Large weld pad.
- Heavy duty latch interlocks with the hook tip. Replacement latches available.
- Detailed installation and application instructions included with each hook.

2

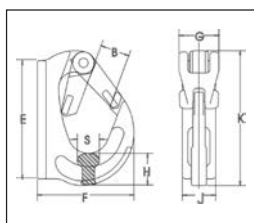

BH-313 Weld-On Hooks

Working Load Limit (t)*	BH-313 Stock No.	Weight Each (lbs.)	Dimensions (in.)								Replacement Latch Stock No.
			B	E	F	G	H	J	K	S	
1	1029105	1.15	.91	3.82	2.80	1.42	1.06	1.02	4.21	.71	1092104
2	1029114	1.85	.91	3.23	3.58	1.42	.98	1.34	4.53	.83	1092104
3	1029123	2.60	1.14	4.61	4.13	1.42	1.22	1.42	5.16	.94	1092104
4	1029132	4.19	1.34	5.16	4.49	1.81	1.42	1.69	5.79	1.14	1092105
5	1029141	5.62	1.34	6.34	5.24	1.85	1.77	1.73	6.81	1.14	1092105
8	1029150	7.28	1.38	6.54	5.31	1.85	2.05	2.05	7.01	1.54	1092105
10	1029169	11.02	1.93	8.07	6.61	1.85	2.24	2.13	8.74	1.54	1092106

*Ultimate Load is 5 times the Working Load Limit.

QUIC-CHECK®



S-3319



- Capacities of 1.63, 2.50 and 4.50 metric tons
- Synthetic Rope sizes: 9/16" - 1-1/16"
- Hook is forged Alloy Steel - Quenched and Tempered.
- Can be proof tested to 2 times the Working Load Limit.
- Designed for utility applications using synthetic rope.
- Design of hook provides needed overhaul weight.
- Utilizes spool & shield designed to:
 - Protect rope
 - Keep rope positioned correctly on spool.
 - Provide wider rope bearing surface resulting in an increased area for load distribution and reduces rope abrasion.
- Low profile hook tip designed to utilize Crosby integrated latch (S-4320), that meets the World class standard for lifting.

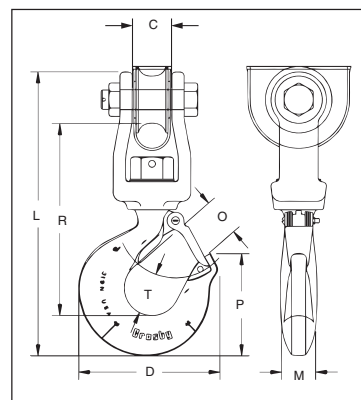

Suitable for infrequent, non continuous rotation under load.
Use in corrosive environment requires shank and nut inspection in accordance with ASME B30.10-1.10.4(b)(5)(c)2009.

S-3319 Utility Swivel Hook

Working Load Limit (t)*	S-3319 Stock No.	Weight Each (lbs.)	Hook ID Code	Synthetic Rope Size (in.)	Dimensions (in.)								Replacement Latch Kit Stock No.
					C	D	L	M	O	P	R	T	
1.63	1002054	4.2	H	9/16 - 5/8	1.09	3.99	8.75	.94	1.16	2.78	5.94	1.16	1096468
2.50	1002063	8.0	I	3/4 - 13/16	1.31	4.84	10.56	1.13	1.41	3.47	7.06	1.53	1096515
4.50	1002072	15.0	J	7/8 - 1-1/16	1.78	6.29	12.75	1.44	1.78	4.59	8.69	1.94	1096562

*Ultimate Load is 5 times the Working Load Limit.



Crosby® Hook Latch Kits

S-4320 Latch Kits



- Heavy duty stamped latch interlocks with the hook tip.
- High cycle, long life spring.
- Can be made into a "Positive Locking" Hook when proper cotter pin is utilized.
- Latch kits shipped unassembled and individually packaged with instructions
- Meets the intent of OSHA Rule 1926.1431(g) of 1926.1501(g) (when secured with the bolt, nut and pin) for lifting personnel.

2

IMPORTANT: The new S-4320 Latch Kit will not fit the old style 319, 320 and 322 hooks.

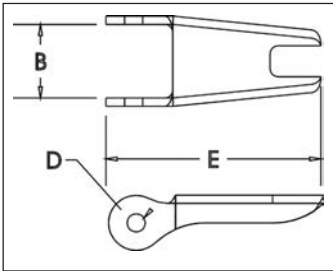

S-4320 Replacement Latch Kit for 319N, 320N, 322N, 339N and NEW 1327 and 1339 Hooks.

Hook Size (t)			Hook ID Code	S-4320 Stock No.	SS-4320 Stock No.*	Weight Each (lbs.)	Dimensions (in.)		
Carbon	Alloy	Bronze					B	D	E
3/4	1	.5	D	1096325	1097100	.03	.50	.15	1.44
1	1-1/2	.6	F	1096374	1097109	.04	.54	.17	1.56
1-1/2	2	1	G	1096421	1097118	.04	.63	.17	1.66
2	3	1.4	H	1096468	1097127	.06	.66	.17	1.91
3	5	2	I	1096515	1097136	.10	.83	.20	2.31
5	7	3.5	J	1096562	1097145	.15	1.04	.20	2.88
7-1/2	11	5	K	1096609	1097154	.28	1.25	.27	3.56
10	15	6.5	L	1096657	1097163	.33	1.35	.27	3.81
15	22	10	N	1096704	1097172	.84	1.66	.39	5.18

*SS-4320 is Stainless Steel construction with cad plated steel nuts.

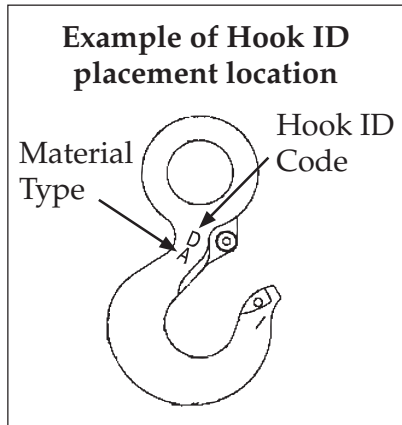

Crosby® Hook Latch Kits

PL LATCH KITS

LATCH ORDERING INSTRUCTIONS

1. Specify PL, PL-N or PL-O latch kit stock number from charts below.
2. Specify capacity of hook to which latch will be assembled.
3. Specify hook material (carbon or alloy).

PL-N/O LATCH KITS

2



PL LATCH

NOTE: The PL latch will not work on 319N, 320N or 322N hooks. The PL-N/O Latches, in the sizes available, will work on both the old and new style hooks.



PL Latch Kits

- Hot dip galvanized.
- Heavy duty latch with easy operating features.
- Flapper lever indicates locked or unlocked position.
- Assembly instructions included with each latch.
- For additional dimensional data on eye, shank or swivel hooks refer to pages 110 through 115 in this section.
- Meets the intent of OSHA Rule 1926.1431(g) and 1926.1501(g) (when secured with the bolt, nut and pin) for lifting personnel.

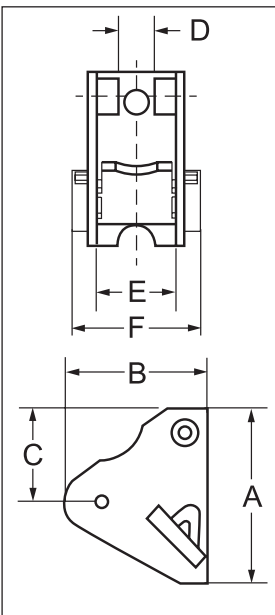

Hook Size (t)		Hook ID Code	PL Latch Kit Stock No.	Weight Each (lbs.)	Dimensions (in.)					
Carbon	Alloy				A	B	C	D	E	F
3	4-1/2	†I	1093711	.54	2.57	2.34	1.94	.56	1.13	2.00
5	7	†J	1093712	.66	3.00	2.34	2.00	.63	1.38	2.22
7-1/2	11	†K	1093713	1.00	3.63	2.77	2.38	.63	1.63	2.38
10	15	†L	1093714	1.25	4.00	3.22	2.69	.63	1.88	3.38
15	22	†N	1093715	2.96	5.31	4.00	2.91	.84	2.38	3.44
20	30	O	1093716	4.05	6.00	4.44	3.19	1.06	2.88	4.25
25	37	P	1093717	8.63	7.00	6.63	4.06	2.24	4.50	6.12
30	45	S	1093718	10.00	6.75	7.00	4.03	2.24	4.75	6.38
40	60	T	1093719	14.30	8.00	7.66	4.38	3.46	5.50	7.25
50	75	U	1093720	27.00	9.88	8.19	5.13	3.38	6.50	8.88
-	100-150	W - X	1093721	33.25	10.88	11.06	6.38	3.38	7.50	10.00
-	200	Y	1093723	45.00	11.88	11.19	6.38	3.38	8.75	11.25
-	300	Z	1093724	55.00	12.50	12.19	8.00	3.38	9.75	13.00

†New 319N style hook.

PL-N/O Latch Kits

- Heavy duty latch with easy operating features.
- PL-N designed for Crosby 319N & 320N style hooks, PL-O designed for Crosby 319 & 320 old style hooks.
- Flapper lever indicates locked or unlocked position.
- Assembly instructions included with each latch.
- Meets the intent of OSHA Rule 1926.1431(g) and 1926.1501(g) (when secured with the supplied toggle pin) for lifting personnel.

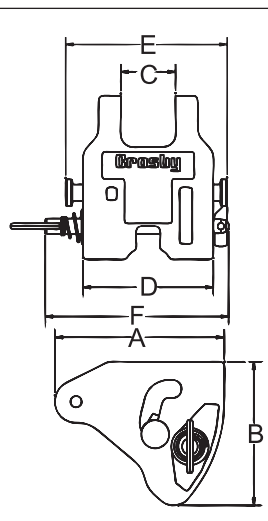

Hook Size (t)		Hook ID Code	PL-N Latch Kit	PL-O Stock No.	Weight Each (lbs.)	Dimensions (in.)					
Carbon	Alloy					A	B	C	D	E	F
3	4.5 / 5 *	I	1092000	1091900	.8	2.40	2.01	.83	2.13	2.71	3.44
5	7	J	1092001	1091901	1.3	2.94	2.50	1.00	2.52	3.19	3.83
7-1/2	11	K	1092002	1091902	2.0	3.63	3.02	1.19	2.75	3.44	4.38
10	15	L	1092003	1091903	2.8	4.00	3.39	1.34	3.19	4.00	4.50
15	22	N	1092004	1091904	4.9	5.19	4.32	1.61	3.86	4.81	5.13

**"N" style hooks are rated at 5 tonnes.



Crosby® Hook Latch Kits

SS-4055



LATCH ORDERING INSTRUCTIONS

1. Specify latch kit stock number.
2. Specify capacity of hook to which latch will be assembled.
3. Specify hook material (carbon or alloy).

2

NOTE: These latches will not work on new "N" style Hooks.

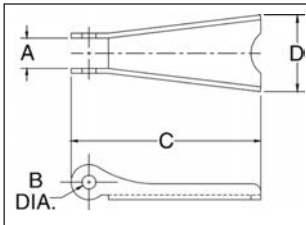

SS-4055 Latch Kits

- Stainless steel construction with cadmium plated steel nuts.
- Shipped packaged and unassembled.
- Instructions included for easy field assembly.

Hook Size (t)			Hook ID Code	SS-4055 Stock No.	Weight Each (lbs.)	Dimensions (in.)			
Carbon	Alloy	Bronze				A	B	C	D
3/4	1	.5	D	1090027	.02	.38	.16	1.44	.59
1	1-1/2	.6	F	1090045	.02	.38	.16	1.60	.59
1-1/2 - 2	2 - 3	1.0 - 1.4	G / H	1090063	.03	.47	.19	1.84	.82
3	4-1/2	2.0	I	1090081	.06	.56	.17	2.41	1.00
5	7	3.5	J	1090107	.11	.58	.20	2.97	1.21
7-1/2 - 10	11 - 15	5.0 - 6.5	K / L	1090125	.17	.59	.27	3.66	1.50
15	22	10.0	N	1090143	.39	.83	.39	4.94	1.90
20	30	--	O	1090161	.63	.94	.52	5.88	2.56
25 - 30	37 - 45	--	P / S	1090189	1.12	2.19	.39	6.50	3.84
40	60	--	T	1090205	1.77	3.31	.52	7.88	4.12

S-4088



S-4088 Alloy Hook Latch Kits

- To be used on A-327 and A-339 Grade 8 Sling Hooks.
- Latch Kits shipped unassembled and individually packaged with instructions.

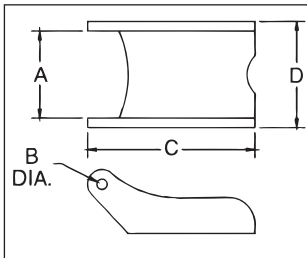

Hook Chain Size (in.)	S-4088 Stock No.	Weight Each (lbs.)	Dimensions (in.)			
			A	B	C	D
9/32 (1/4)	1090250	.06	.78	.16	2.03	.94
3/8	1090251	.14	1.03	.19	2.69	1.25
1/2	1090252	.15	1.03	.19	3.00	1.25
5/8	1090253	.15	1.03	.19	3.25	1.25
3/4	1090254	.15	1.53	.26	4.13	1.88
7/8	1090255	.15	1.53	.26	4.66	2.00

Alloy Master Links

Load Rated

Fatigue Rated



A-342



- Alloy Steel — Quenched and Tempered.
- Individually Proof Tested to values shown, with certification.
- Proof Tested with 60% inside width special fixtures sized to prevent localized point loading per ASME A-952.
- Meets or exceeds all requirements of ASME B30.26 including identification, ductility, design factor, proof load and temperature requirements. Importantly, these links meet other critical performance requirements including fatigue life, impact properties and material traceability, not addressed by ASME B30.26.
- Forgings have a Product Identification Code (PIC) for material traceability, along with the size, the name Crosby and USA in raised lettering.
- Selected sizes designated with "W" in the size column have enlarged inside dimensions to allow additional room for sling hardware and crane hook.
- Crosby 1 1/4" to 2" 342/345 master links are type approved to DNV Certification Notes 2.7-1- Offshore Containers. These Crosby master links are 100% proof tested, MPI and impact tested. The tests are conducted by Crosby and 3.1 test certification is available upon request. Refer to page 161 for Crosby COLD TUFF® master links that meet the additional requirements of DNV rules for certification of lifting applications - Loose Gear.
- Incorporates patented QUIC-CHECK® deformation indicators.

A-342 Alloy Master Links

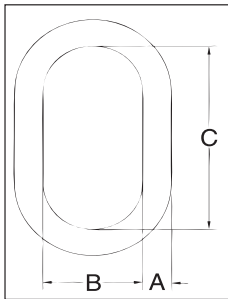

Size		A-342 Stock No	Weight Each (lbs.)	Working Load Limit (lbs.)	Proof Load (lbs.)**	Dimensions (in.)			
(in.)	(mm)					A	B	C	Deformation Indicator
1/2W	13W	1014266	1.3	7400	17200	.62	2.80	5.00	3.50
5/8	16	1014280	1.5	9000	18000	.62	3.00	6.00	3.50
3/4W	19W	1014285	2.0	12300	28400	.73	3.20	6.00	4.00
7/8W	22W	1014319	3.3	15200	35200	.88	3.75	6.38	4.50
1W	26W	1014331	6.1	26000	60000	1.10	4.30	7.50	5.50
1-1/4W	32W	1014348	12.0	39100	90400	1.33	5.50	9.50	7.00
1-1/2W	38W	1014365	18.6	61100	141200	1.61	5.90	10.50	7.50
1-3/4	44	1014388	25.2	84900	212250	1.75	6.00	12.00	7.50
2	51	1014404	37.0	102600	256500	2.00	7.00	14.00	9.00
2-1/4	57	1014422	54.1	143100	289200	2.25	8.00	16.00	10.00
2-1/2	63	1014468	68.5	160000	320000	2.50	8.38	16.00	11.00
2-3/4	70	1014440	94.0	216900	433800	2.75	9.88	18.00	12.50
3	76	1014486	115	228000	456000	3.00	9.88	18.00	13.00
3-1/4	83	1014501	145	262200	524400	3.25	10.00	20.00	13.50
3-1/2	89	1014529	200	279000	558000	3.50	12.00	24.00	15.50
3-3/4	95	1015051	198	336000	672000	3.75	10.00	20.00	13.50
4	102	1015060	264	373000	746000	4.00	12.00	24.00	16.00
†† 4-1/4	†† 108	1015067	302	354000	708000	4.25	12.00	24.00	-
†† 4-1/2	†† 114	1015079	345	360000	720000	4.50	14.00	28.00	-
†† 4-3/4	†† 121	1015088	436	389000	778000	4.75	14.00	28.00	-
†† 5	†† 127	1015094	516	395000	790000	5.00	15.00	30.00	-

*Ultimate Load is 5 times the Working Load Limit. Based on single leg sling (in-line load), or resultant load on multiple legs with an included angle less than or equal to 120 degrees. Applications with wire rope and synthetic sling generally require a design factor of 5.

** Proof Test Load equals or exceeds the requirement of ASTM A952(8.1) and ASME B30.9. †† Welded Master Link.

A-345



A-345 Master Link Assembly with Engineered Flat for use with S-1325A coupler link.

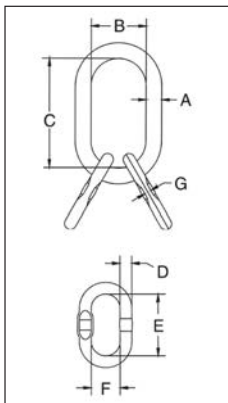

Size		A-345 Stock No.	Weight Each (lbs.)	Working Load Limit Based on 5:1 Design Factor (lbs.)	Proof Load (lbs.)**	Dimensions (in.)							
(in.)	(mm)					A	B	C	D	E	F	G	Deformation Indicator
3/4W	19W	1014739	3.5	12300	28400	.73	3.20	6.00	.56	3.35	1.77	.30	4.00
7/8W	22W	1014742	4.8	15200	35200	.88	3.75	6.38	.56	3.35	1.77	.30	4.50
1W	26W	1014766	9.3	26000	60000	1.10	4.30	7.50	.75	3.94	2.36	.33	5.50
1-1/4W	32W	1014779	15.8	39100	90400	1.33	5.50	9.50	1.00	6.30	3.54	.51	7.00
1-1/2W	38W	1014807	34.1	61100	141200	1.61	5.90	10.50	1.25	7.09	3.94	.65	7.50
1-3/4	44	1014814	46.7	84900	212250	1.75	6.00	12.00	1.38	8.00	5.00	.73	7.50
2	51	1014832	67.2	102600	256500	2.00	7.00	14.00	1.50	9.00	5.75	-	9.00
2-1/2	64	1014855	206	160000	320000	2.50	8.38	16.00	2.50	16.00	8.38	-	11.00
2-3/4	70	1014864	282	216900	433800	2.75	9.88	18.00	2.75	18.00	9.88	-	12.50
4	102	1014999	667	373000	746000	4.00	12.00	24.00	3.50	24.00	12.00	-	15.50**

* Ultimate Load is 5 times the Working Load Limit. The maximum individual sublink working load limit is 75% of the assembly working load limit except for 2-1/2" and 2-3/4", which are 100% of assembly working load limit. Applications with wire rope and synthetic sling generally require a design factor of 5.

** Proof Test Load equals or exceeds the requirement of ASTM A952(8.1) and ASME B30.9. *** Sublink only.



Steel Links

2

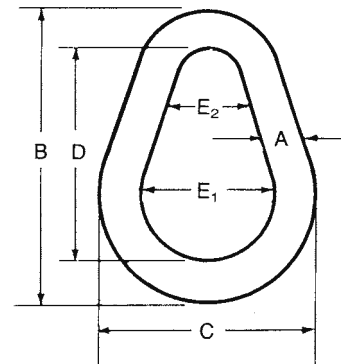

HEAT-TREATED, HIGH TEST CARBON STEEL PEAR SHAPE LINK

Size A	Dimensions in Inches					Rated Load Single Pull Pounds	Weight Each Pounds
	B	C	D	E ₁	E ₂		
3/8	3	2 1/4	2 1/4	1 1/2	3/4	1,800	.23
1/2	4	3	3	2	1	2,900	.51
5/8	5	3 3/4	3 3/4	2 1/2	1 1/4	4,200	1.08
3/4	6	4 1/2	4 1/2	3	1 1/2	6,000	1.90
7/8	7	5 1/4	5 1/4	3 1/2	1 3/4	8,300	2.90
1	8	6	6	4	2	10,800	4.60
1 1/4	10	7 1/2	7 3/4	5	2 1/2	16,750	9.20
1 3/8	11	8 1/4	8 1/4	5 1/2	2 3/4	20,500	11.00
1 1/2	12	9	9	6	3	25,000	14.30
1 3/4	14	10 1/2	10 1/2	7	3 1/2	34,000	22.60
2	16	12	12	8	4	45,000	33.80
2 1/4	18	13 1/2	13 1/2	9	4 1/2	56,000	48.20
2 1/2	20	15	15	10	5	68,500	66.00
2 3/4	22	16 1/2	16 1/2	11	5 1/2	84,500	88.00
3	24	18	18	12	6	100,000	114.00
3 1/4	26	19 1/2	19 1/2	13	6 1/2	117,500	146.00
3 1/2	28	21	21	14	7	136,500	181.00
3 3/4	30	22 1/2	22 1/2	15	7 1/2	155,000	223.00
4	32	24	24	16	8	176,000	271.00

NOTES: Available in larger sizes and alloy steel per special order.
 Minimum breaking strength is six times the rated working load.
 Galvanized on request only.
 Ridgeless electrically side welded.

UNC Swivel Hoist Rings

Load Rated Fatigue Rated

HR-125



- Top washer has the following features:
 - The Working Load Limit and Recommended Torque value are permanently stamped into each washer.
 - Washer is color coded for easy identification: Red - UNC thread.
- Individually Proof Tested to 2-1/2 times Working Load Limit.
- Bolt specification is an Alloy socket head cap screw to ASTM A 574.
- All threads listed are UNC.
- **BOLT SIZE IDENTIFICATION:** The size of the bolt will be stated as in the drawing below. Illustration shows meaning of each dimension given.
- Frame 2 and larger are **RFID EQUIPPED**.

2

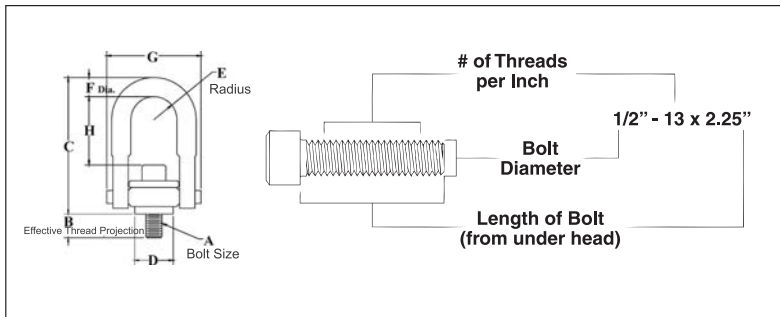

HR-125 UNC Threads

Frame Size No.	HR-125 Stock No.	Working Load Limit (lbs.)*	Torque in Ft. Lbs.	Dimensions (in.)								Weight Each (lbs.)
				Bolt Size A ‡	Effective Thread Projection Length B	C	D	Radius E	Diameter F	G	H	
1 †	1016887	800	7	5/16 - 18 x 1.50	.58	2.72	.97	.46	.34	1.87	1.12	.37
1 †	1016898	1000	12	3/8 - 16 x 1.50	.58	2.72	.97	.46	.34	1.87	1.05	.39
2	1016909	2500	28	1/2 - 13 x 2.00	.70	4.85	1.96	.87	.75	3.35	2.29	2.33
2 †	1016912	2500	28	1/2 - 13 x 2.50	1.20	4.85	1.96	.87	.75	3.35	2.29	2.36
2	1016920	4000	60	5/8 - 11 x 2.00	.70	4.85	1.96	.87	.75	3.35	2.16	2.41
2 †	1016924	4000	60	5/8 - 11 x 2.75	1.45	4.85	1.96	.87	.75	3.35	2.16	2.47
2	1016931	5000	100	3/4 - 10 x 2.25	.95	4.85	1.96	.87	.75	3.35	2.04	2.52
2 †	1016935	5000	100	3/4 - 10 x 2.75	1.45	4.85	1.96	.87	.75	3.35	2.04	2.59
3	1016942	7000 **	100	3/4 - 10 x 2.75	.89	6.57	2.96	1.36	.94	4.87	2.97	6.72
3 †	1016946	7000 **	100	3/4 - 10 x 3.50	1.64	6.57	2.96	1.36	.94	4.87	2.97	6.81
3	1016953	8000	160	7/8 - 9 x 2.75	.89	6.57	2.96	1.36	.94	4.87	2.84	6.84
3 †	1016957	8000	160	7/8 - 9 x 3.50	1.64	6.57	2.96	1.36	.94	4.87	2.84	6.96
3	1016964	10000	230	1 - 8 x 3.00	1.14	6.57	2.96	1.36	.94	4.87	2.72	7.09
3 †	1016969	10000	230	1 - 8 x 4.00	2.14	6.57	2.96	1.36	.94	4.87	2.72	7.31
4	1016975	15000	470	1-1/4 - 7 x 4.50	2.21	8.72	3.71	1.75	1.19	6.18	3.93	14.51
5	1016986	24000	800	1-1/2 - 6 x 6.75	3.00	12.55	4.71	2.39	1.75	8.48	5.52	37.73
5	1016997	30000	1100	2 - 4-1/2 x 6.75	3.00	12.55	4.71	2.39	1.75	8.48	5.02	40.69
6	1017001	50000	2100	2-1/2 - 4 x 8.0	4.00	16.88	5.75	3.00	2.25	11.00	8.03	88.00
7	1017005	75000	4300	3 - 4 x 10.5	5.00	19.50	7.25	3.75	2.75	14.16	8.50	166.00
8	1017009	100000	5100	3-1/2 - 4 x 13.0 #	7.00	22.09	7.75	4.00	3.25	15.91	9.28	265.00

*Ultimate Load is 5 times the Working Load Limit.

** Ultimate Load is 4.5 times the Working Load Limit for 7000# Hoist Ring when tested in 90 degree orientation.

† Long Bolts are designed to be used with soft metal (i.e., aluminum) workpiece. While the long bolts may also be used with ferrous metal (i.e., steel & iron) workpiece, short bolts are designed for ferrous workpieces only.

‡ Bolt specification is an Alloy socket head cap screw to ASTM A 574.

Hex head bolt used on Frame 8 (100,000lb.) Hoist Ring.



Drop Forged Swivels

CAUTION: NEVER EXCEED WORKING LOAD LIMIT.
 Read important warnings and information preceding fittings section.
SWIVELS ARE NOT INTENDED TO ROTATE UNDER LOAD.

JAW & EYE SWIVELS

Meets or exceeds the performance requirements of Federal Specification RR-C-271 (latest revision).
 Hot galvanized.

2

Size (A) in Inches	Working Load Limit in Pounds	Approximate Weight Each in Pounds	Dimensions in Inches					
			B	C	D	E	F	G
¼	850	.22	.69	.75	.38	.88	2.69	.25
⅜	1,200	.39	.88	1.00	.50	.88	2.88	.31
½	2,250	.71	.94	1.25	.63	1.00	3.50	.38
⅝	3,600	1.4	1.38	1.50	.81	1.31	4.50	.50
¾	5,200	2.3	1.63	1.75	1.00	1.50	5.31	.63
⅞	7,200	3.5	1.75	2.00	1.19	1.75	6.06	.75
1	10,000	5.7	2.08	2.25	1.20	2.07	7.06	.88
1 ¼	12,500	9.5	2.27	2.44	1.73	2.81	8.56	1.12
1 ½	18,000	15.7	2.69	3.13	2.06	2.81	9.44	1.38
1 ¾	45,200	55.0	4.20	4.00	2.37	4.43	14.75	2.25

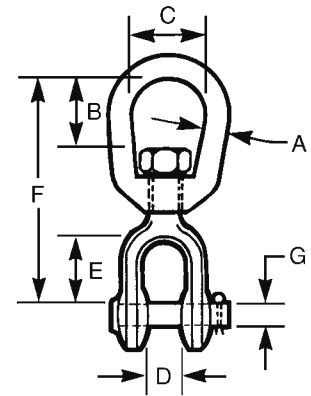

EYE & EYE SWIVELS

Meets or exceeds the performance requirements of Federal Specification RR-C-271 (latest revision).
 Hot galvanized.

Size (A) in Inches	Working Load Limit in Pounds	Approximate Weight Each in Pounds	Dimensions in Inches			
			B	C	E	F
¼	850	.2	.69	.75	.94	2.88
⅜	1,200	.38	.75	1.00	1.13	3.63
½	2,250	.68	.94	1.25	1.38	4.25
⅝	3,600	1.4	1.38	1.50	1.94	5.63
¾	5,200	2.5	1.63	1.75	2.31	6.63
⅞	7,200	3.8	1.81	2.00	2.56	7.25
1	10,000	6.0	2.06	2.25	3.02	8.28
1 ¼	12,500	8.5	2.35	2.48	3.43	9.53
1 ½	18,000	16.3	2.69	3.13	3.69	11.13
1 ¾	45,200	46.0	4.18	4.00	4.18	17.12

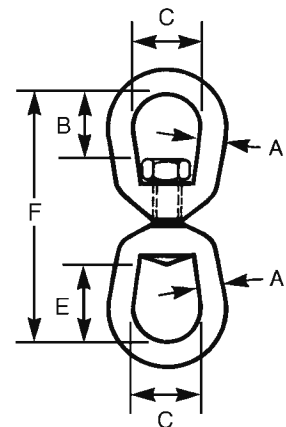

Wire Rope Slings

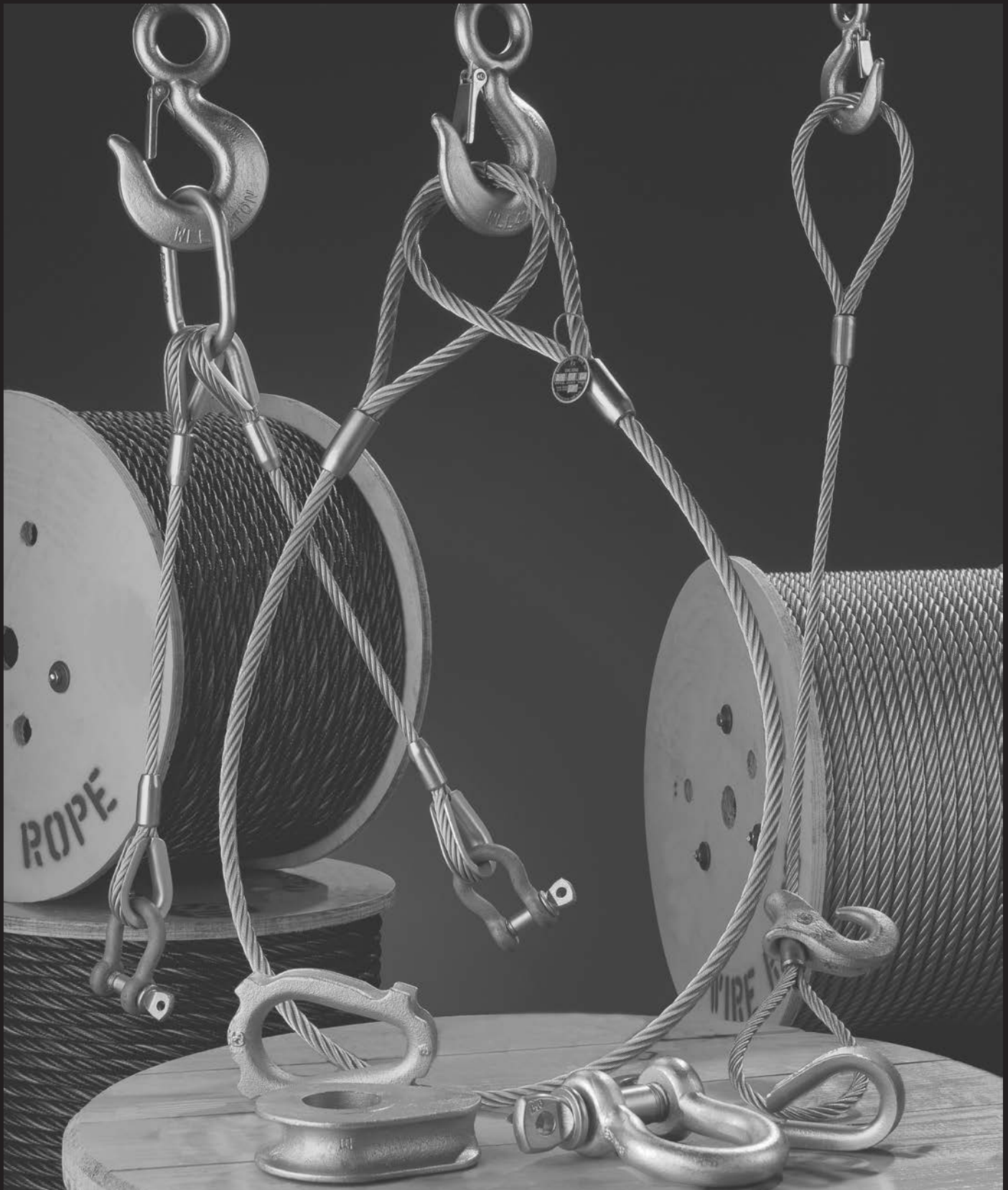



Type 11 Slings

Flemished Eye and Mechanically Swaged

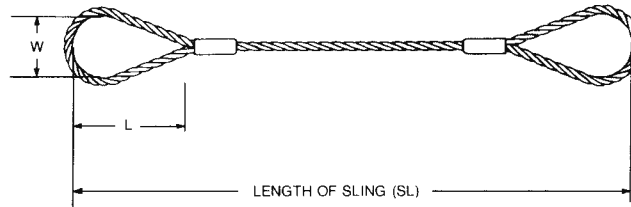

Diam. Of Wire Rope Inches	Min. Length (SL) Of Sling Ft.-In.	Inside Loop Dimensions W Inches L Inches		Rated Capacity In Tons (2000 lbs.)					
				EIPS-IWRC					
				Single Leg Vertical	Choker Hitch	Basket Hitch**			
						Straight Pull	60°	45°	30°
1/4	1-6	2	4	.65	.48	1.3	1.1	.91	.65
5/16	1-9	2 1/2	5	1.00	.74	2.0	1.7	1.40	1.00
3/8	2-0	2 1/2	6	1.40	1.10	2.9	2.5	2.00	1.40
7/16	2-3	3 1/2	7	1.90	1.40	3.9	3.4	2.70	1.90
1/2	2-6	4	8	2.50	1.90	5.1	4.4	3.60	2.50
9/16	2-9	4 1/2	9	3.20	2.40	6.4	5.5	4.50	3.20
5/8	3-0	5	10	3.90	2.90	7.8	6.8	5.50	3.90
3/4	3-6	6	12	5.60	4.10	11.0	9.7	7.90	5.60
7/8	4-0	7	14	7.60	5.60	15.0	13.0	11.00	7.60
1	4-6	8	16	9.80	7.20	20.0	17.0	14.00	9.80
1 1/8	5-0	9	18	12.00	9.10	24.0	21.0	17.00	12.00
1 1/4	5-6	10	20	15.00	11.00	30.0	26.0	21.00	15.00
1 3/8	6-0	11	22	18.00	13.00	36.0	31.0	25.00	18.00
1 1/2	7-0	12	24	21.00	16.00	42.0	37.0	30.00	21.00
1 5/8	7-6	13	26	24.00	18.00	49.0	42.0	35.00	24.00
1 3/4	8-0	14	28	28.00	21.00	57.0	49.0	40.00	28.00
2	9-0	16	32	37.00	28.00	73.0	63.0	52.00	37.00
2 1/4	10-0	18	36	44.00	35.00	89.0	77.0	63.00	44.00
2 1/2	11-0	20	40	54.00	42.00	109.0	94.0	77.00	54.00
2 3/4	12-0	22	44	65.00	51.00	130.0	113.0	92.00	65.00
3	13-0	24	48	77.00	60.00	153.0	133.0	108.00	77.00
3 1/4	17-8	32	64	89.00	69.00	177.0	153.0	125.00	89.00
3 1/2	19-8	36	72	102.00	79.00	203.0	176.0	144.00	102.00
3 3/4	21-6	40	80	115.00	87.00	231.0	200.0	163.00	115.00
4	23-8	45	90	130.00	97.00	259.0	224.0	183.00	130.00

*Rated capacities of choker hitches apply when the angle of choke is greater than 135°.

**Rated capacities of basket hitches are based on a minimum diameter of curvature at the point of load contact of 20 times the rope diameter.

For approximate capacities using Fiber Core IPS: deduct 10% from IPS-IWRC strengths.

For approximate capacities on Hand Braided Slings: deduct 15% from corresponding mechanically swaged strengths.

For approximate capacities on Socket Attachments: add 5% to corresponding IWRC swaged strengths.

Wire Rope Diam. Inches	Heavy Duty Thimble		Alloy Hook Size-Tons	Carbon Shackle With Thimble Size-Inches	Open Swaged Socket		Closed Swaged Socket	
	Inside Width Inches	Length Inches	For EIPS	For EIPS	Pin Size Inches	Jaw Size Inches	Hole Diam. Inches	Head Opening Inches
6 × 19 WITH I. W. R. C								
1/4	7/8	1 5/8	1	5/16	1 1/16	1 1/16	3/4	1/2
5/16	1 1/16	1 7/8	1 1/2	3/8	13/16	13/16	7/8	1 1/16
3/8	1 1/8	2 1/8	2	7/16	13/16	13/16	7/8	1 1/16
7/16	1 1/4	2 3/8	3	1/2	1	1	1 1/16	7/8
1/2	1 1/2	2 3/4	4 1/2	5/8	1	1	1 1/16	7/8
9/16	1 1/2	2 3/4	4 1/2	5/8	1 3/16	1 1/4	1 1/4	1 1/8
5/8	1 3/4	3 1/4	7	3/4	1 3/16	1 1/4	1 1/4	1 1/8
3/4	2	3 3/4	11	7/8	1 3/8	1 1/2	1 7/16	1 9/16
7/8	2 1/4	4 1/4	11	1	1 5/8	1 3/4	1 11/16	1 1/2
1	2 1/2	4 1/2	15	1 1/4	2	2	2 1/16	1 3/4
1 1/8	2 7/8	5 1/8	22	1 1/4	2 1/4	2 1/4	2 5/16	2
6 × 37 WITH I. W. R. C								
1 1/4	2 7/8	5 1/8	22	1 1/2	2 1/2	2 1/2	2 9/16	2 1/4
1 3/8	2 7/8	5 1/8	30	1 3/4	2 1/2	2 1/2	2 9/16	2 1/4
1 1/2	3 1/2	6 1/4	30	1 3/4	2 3/4	3	2 13/16	2 1/2
1 5/8	4	8	30	1 3/4	3 1/2	3 1/2	3 9/16	3
1 3/4	4 1/2	9	37	2	3 1/2	3 1/2	3 9/16	3
2	6	12	60	2 1/2	3 3/4	4	3 13/16	3 1/4
2 1/4	7	14	60	2 1/2	4 1/4	4 1/4	4 5/16	4
2 1/2	—	—	—	3	4 1/4	4 1/4	4 5/16	4
2 3/4	—	—	—	3	—	—	—	—
3	—	—	—	3	—	—	—	—
3 1/4	—	—	—	3 1/2	—	—	—	—
3 1/2	—	—	—	3 1/2	—	—	—	—
3 3/4	—	—	—	4	—	—	—	—
4	—	—	—	4	—	—	—	—



Type 11 Slings

SLINGS WITH SINGLE-ROPE LEGS AND OPEN AND/OR CLOSED SOCKETS (POURED ATTACHED)

**TYPE 11
OPEN SOCKETS**

**TYPE 11
OPEN AND CLOSED SOCKETS**

**TYPE 11
CLOSED SOCKETS**

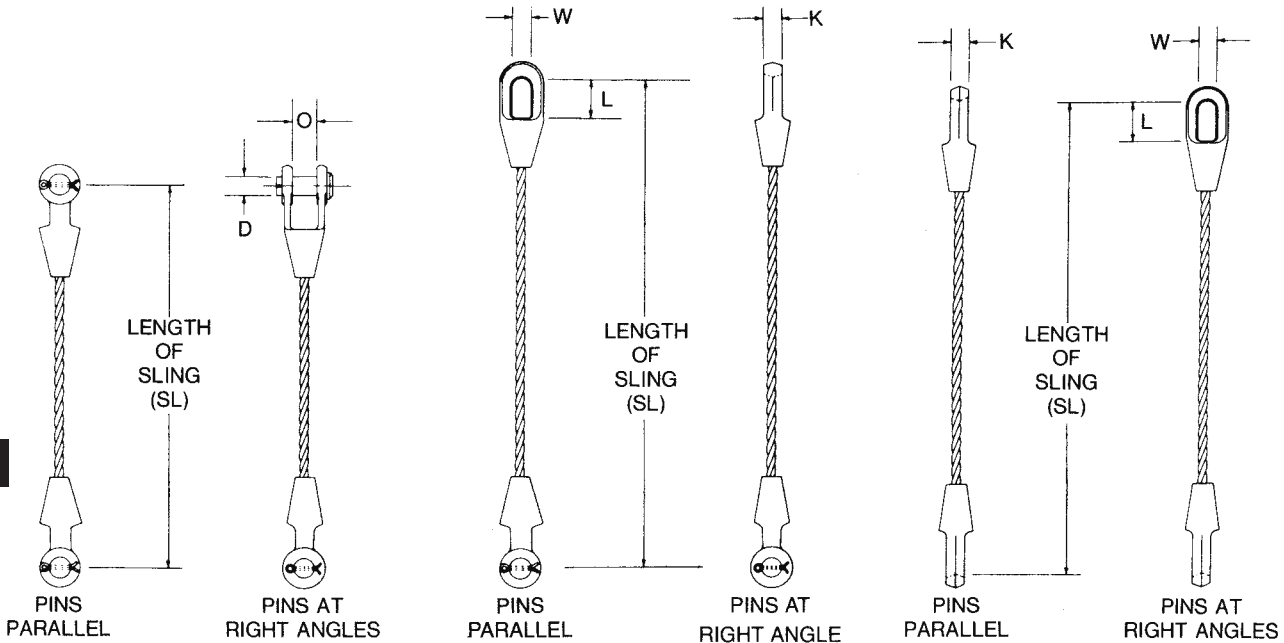

3

Diameter Of Wire Rope Inches	Minimum Length (SL) Of Sling Ft.-In.	Rated Capacities In Tons (2,000 lbs.)				Important Dimensions				
		Single Part Vertical	EIPS-IWRC Two Slings When Used @			Open Socket		Closed Socket		
			60°	45°	30°	O Inches	D Inches	W Inches	L Inches	K Inches
1/4	1-0	.68	1.2	.96	.68	1 1/16	1 1/16	1 3/16	1 3/4	1/2
5/16	1-0	1.10	1.9	1.60	1.10	1 3/16	1 3/16	1 5/16	2	1 1/16
3/8	1-0	1.50	2.6	2.10	1.50	1 3/16	1 3/16	1 5/16	2	1 1/16
7/16	1-2	2.00	3.5	2.80	2.00	1	1	1 1/8	2 1/4	7/8
1/2	1-3	2.60	4.6	3.70	2.60	1	1	1 1/8	2 1/4	7/8
9/16	1-5	3.40	5.9	4.80	3.40	1 1/4	1 3/16	1 3/8	2 1/2	1
5/8	1-6	4.10	7.1	5.90	4.10	1 1/4	1 3/16	1 3/8	2 1/2	1
3/4	1-9	5.90	10.0	8.30	5.90	1 1/2	1 3/8	1 5/8	3	1 1/4
7/8	2-0	7.90	14.0	11.00	7.90	1 3/4	1 5/8	1 7/8	3 1/2	1 1/2
1	2-6	10.00	17.0	15.00	10.00	2	2	2 1/4	4	1 3/4
1 1/8	2-9	13.00	22.0	18.00	13.00	2 1/4	2 1/4	2 1/2	4 1/2	2
1 1/4	3-0	16.00	28.0	23.00	16.00	2 1/2	2 1/2	2 3/4	5	2 1/4
1 3/8	3-0	20.00	33.0	28.00	20.00	2 1/2	2 1/2	2 3/4	5	2 1/4
1 1/2	3-3	23.00	39.0	32.00	23.00	3	2 3/4	3 1/8	6	2 1/2
1 5/8	3-9	26.00	46.0	37.00	26.00	3	3	3 1/4	6 1/2	2 3/4
1 3/4	4-3	31.00	53.0	44.00	31.00	3 1/2	3 1/2	3 17/32	7 9/16	3
2	4-9	39.00	68.0	56.00	39.00	4	3 3/4	3 25/32	8 9/16	3 1/4
2 1/4	5-0	49.00	85.0	70.00	49.00	4 1/2	4 1/4	4 9/32	9 1/2	3 5/8
2 1/2	5-9	60.00	104.0	85.00	60.00	5	4 3/4	5 1/2	10 5/8	4
2 3/4	6-5	72.00	125.0	102.00	72.00	5 1/4	5	6 1/2	11 1/4	4 7/8
3	6-10	85.00	147.0	120.00	85.00	5 3/4	5 1/4	6 3/4	11 3/4	5 1/4
3 1/4	7-7	98.00	170.0	139.00	98.00	6 1/4	5 1/2	7 1/4	12 1/4	5 3/4
3 1/2	8-2	113.00	196.0	160.00	113.00	6 3/4	6	7 1/4	13	6 1/4
3 3/4	8-8	128.00	222.0	181.00	128.00	7 1/2	7	8 1/2	14	7
4	9-1	143.00	248.0	202.00	143.00	7 1/2	7	8 1/2	14	7

Sockets available up through 6" diameter wire rope upon request.



Type 11 Slings

SLINGS WITH SINGLE-ROPE LEGS AND OPEN AND/OR CLOSED SOCKETS*

**TYPE 11
OPEN SWAGED
SOCKETS**

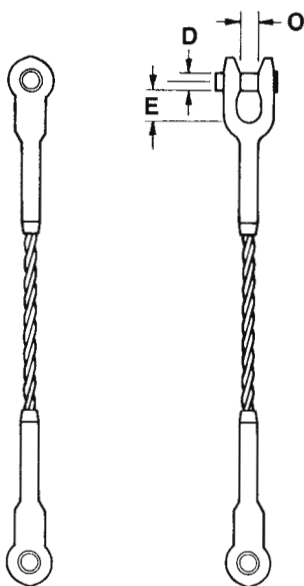

**PINS
PARALLEL**

**PINS AT
RIGHT ANGLES**

**TYPE 11
OPEN AND CLOSED
SWAGED SOCKETS**

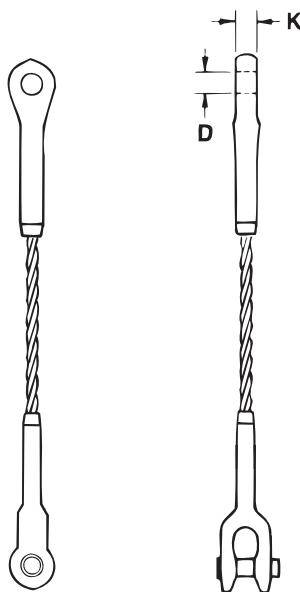

**PINS
PARALLEL**

**PINS AT
RIGHT ANGLES**

**TYPE 11
CLOSED SWAGED
SOCKETS**

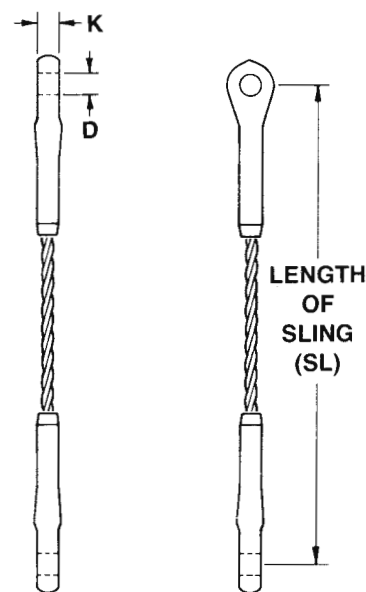

**PINS
PARALLEL**

**PINS AT
RIGHT ANGLES**

Diameter Of Wire Rope Inches	Minimum Length (SL) Of Sling Ft.-In.	Rated Capacity In Tons (2000 lbs) EIPS-IWRC				Important Dimensions				
		Single Part Vertical	Two Slings When Used @			Open Swage Socket			Closed Swage Socket	
			60°	45°	30°	O Inches	D Inches	E Inches	K Inches	D Inches
1/4	0-11	.68	1.2	.96	.68	1 1/16	1 1/16	1 5/32	1/2	3/4
5/16	1-1	1.10	1.9	1.60	1.10	13/16	13/16	1 11/32	1 1/16	7/8
3/8	1-3	1.50	2.6	2.10	1.50	13/16	13/16	1 11/32	1 1/16	7/8
7/16	1-6	2.00	3.5	2.80	2.00	1	1	1 1/2	7/8	1 1/16
1/2	1-8	2.60	4.6	3.70	2.60	1	1	1 1/2	7/8	1 1/16
9/16	1-10	3.40	5.9	4.80	3.40	1 1/4	1 3/16	1 21/32	1 1/8	1 1/4
5/8	2-0	4.10	7.1	5.90	4.10	1 1/4	1 3/16	1 21/32	1 1/8	1 1/4
3/4	2-5	5.90	10.0	8.30	5.90	1 1/2	1 3/8	2 1/16	1 5/16	1 7/16
7/8	2-10	7.90	14.0	11.00	7.90	1 3/4	1 5/8	2 7/16	1 1/2	1 11/16
1	3-2	10.00	17.0	15.00	10.00	2	2	2 3/4	1 3/4	2 1/16
1 1/8	3-7	13.00	22.0	18.00	13.00	2 1/4	2 1/4	3 1/8	2	2 5/16
1 1/4	4-0	16.00	28.0	23.00	16.00	2 1/2	2 1/2	3 1/2	2 1/4	2 9/16
1 5/8	4-5	20.00	33.0	28.00	20.00	2 1/2	2 1/2	4	2 1/4	2 9/16
1 1/2	4-9	23.00	39.0	32.00	23.00	3	2 3/4	4 3/8	2 1/2	2 13/16
1 5/8	5-1	26.00	46.0	37.00	26.00	3 1/2	3 1/2	5	3	3 9/16
1 3/4	5-5	31.00	53.0	44.00	31.00	3 1/2	3 1/2	5	3	3 9/16
2	6-4	39.00	68.0	56.00	39.00	4	3 3/4	6 1/8	3 1/4	3 13/16
2 1/4	7-2	49.00	85.0	70.00	49.00	4 1/4	4 1/4	4 5/8	4	4 5/16
2 1/2	8-0	60.00	104.0	85.00	60.00	4 1/4	4 1/4	4 5/8	4	4 5/16

*Interchangeable with zinc sockets.



Type 21 Slings

FLEMISHED EYE AND MECHANICALLY SWAGED

Type 21 slings are 2-leg All-Purpose bridles, designed for general lifting purposes where attachment may be made directly to the load, such as hooking into lifting eyes or placing loops over lugs.

Diam. Of Wire Rope Inches	Min. Length (SL) Of Sling Ft.-In.	Rated Capacities in Tons EIPS-IWRC			Alloy Links Diam. Inches
		60°	45°	30°	
1/4	1-3	1.10	.91	.65	1/2
5/16	1-6	1.70	1.40	1.00	1/2
3/8	1-8	2.50	2.00	1.40	3/4
7/16	1-10	3.40	2.70	1.90	7/8
1/2	2-0	4.40	3.60	2.50	1
9/16	2-2	5.50	4.50	3.20	1 1/4
5/8	2-4	6.80	5.50	3.90	1 1/4
3/4	2-9	9.70	7.90	5.60	1 1/4
7/8	3-3	13.00	11.00	7.60	1 1/2
1	3-6	17.00	14.00	9.80	1 1/2
1 1/8	4-0	21.00	17.00	12.00	1 3/4
1 1/4	4-6	26.00	21.00	15.00	2
1 3/8	5-0	31.00	25.00	18.00	2
1 1/2	5-6	37.00	30.00	21.00	2 1/4
1 5/8	6-0	42.00	35.00	24.00	2 1/2
1 3/4	6-6	49.00	40.00	28.00	2 1/2
2	8-0	63.00	52.00	37.00	2 3/4
2 1/4	8-9	77.00	63.00	44.00	3 1/4
2 1/2	10-0	94.00	77.00	54.00	3 3/4

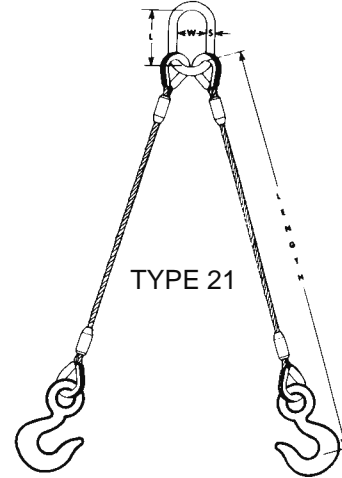

For approximate capacities using Fiber Core EIP: deduct 10% from EIP-IWRC strengths.
 For approximate capacities on Hand Braided Slings: deduct 15% from corresponding mechanically swaged strengths.
 For approximate capacities on Socket Attachments: add 5% to corresponding IWRC swaged strengths.

PERTINENT DIMENSIONS FOR END FITTINGS

Diam. Of Wire Rope Inches	Standard Loop Inside		Heavy Duty Thimble Inside		Alloy Hook Size-Tons For EIPS	Carbon Shackle Size-Inches For EIPS	Half Thimble Inside Loop		Open Swage Socket		Closed Swage Socket	
	Width Inches	Length Inches	Width Inches	Length Inches			Width Inches	Length Inches	Pin Diam. Inches	Jaw Opening Inches	Hole Diam. Inches	Head Thickness Inches
6 × 19 with IWRC												
1/4	2	4	7/8	1 5/8	1	5/16	—	—	1 1/16	1 1/16	3/4	1/2
5/16	2 1/2	5	1 1/16	1 7/8	1 1/2	3/8	—	—	1 3/16	1 3/16	7/8	1 1/16
3/8	3	6	1 1/8	2 1/8	2	1/2	2	4	1 3/16	1 3/16	7/8	1 1/4
7/16	3 1/2	7	1 1/4	2 3/8	3	1/2	2 1/4	5	1	1	1 1/16	7/8
1/2	4	8	1 1/2	2 3/4	4 1/2	5/8	2 1/4	5 1/2	1	1	1 1/16	7/8
9/16	4 1/2	9	1 1/2	2 3/4	4 1/2	5/8	2 1/4	5 1/2	1 3/16	1 1/4	1 1/4	1 1/8
5/8	5	10	1 3/4	3 1/4	7	3/4	3 1/4	7	1 3/16	1 1/4	1 1/4	1 1/8
3/4	6	12	2	3 3/4	11	7/8	3 1/4	9	1 3/8	1 1/2	1 1/16	1 3/16
7/8	7	14	2 1/4	4 1/4	11	1	4 1/2	10 1/2	1 5/8	1 3/4	1 11/16	1 1/2
1	8	16	2 1/2	4 1/2	15	1 1/4	4 1/2	12	2	2	2 1/16	1 3/4
1 1/8	9	18	2 7/8	5 1/8	22	1 1/4	4 5/8	13 1/2	2 1/4	2 1/4	2 5/16	2
6 × 37 with IWRC												
1/4	10	20	2 7/8	5 1/8	22	1 1/2	5 1/2	15	2 1/2	2 1/2	2 9/16	2 1/4
1 3/8	11	22	3 1/2	6 1/4	30	1 3/4	6	17	2 1/2	2 1/2	2 9/16	2 1/4
1 1/2	12	24	3 1/2	6 1/4	30	1 3/4	6 1/2	18	2 3/4	3	2 13/16	2 1/2
1 5/8	13	26	4	8	30	1 3/4	6 1/2	18	3 1/2	3 1/2	3 1/16	3
1 3/4	14	28	4 1/2	9	37	2	7	21 1/2	3 1/2	3 1/2	3 3/16	3
2	16	32	6	12	60	2 1/2	7	24 1/2	3 3/4	4	3 13/16	3 1/4
2 1/4	18	36	7	14	60	2 1/2	8 1/2	25 1/2	4 1/4	4 1/4	4 5/16	4
2 1/2	20	40	—	—	—	3	8 1/2	26 1/2	4 1/4	4 1/4	4 5/16	4
2 3/4	22	44	—	—	—	3	10	30	—	—	—	—
3	24	48	—	—	—	3	10	32	—	—	—	—
3 1/4	—	—	—	—	—	3 1/2	—	—	—	—	—	—
3 1/2	—	—	—	—	—	3 1/2	—	—	—	—	—	—
3 3/4	—	—	—	—	—	4	—	—	—	—	—	—
4	—	—	—	—	—	4	—	—	—	—	—	—



Type 31 Slings

FLEMISHED EYE & MECHANICALLY SWAGED

Type 31 slings are 3-leg All-Purpose bridles, generally recommended for handling unbalanced loads.

Diam. Of Wire Rope Inches	Min. Length (SL) Of Sling Ft.-in.	Rated Capacities in Tons EIPS-IWRC			Alloy Links Diam. Inches
		60°	45°	30°	
1/4	1-3	1.70	1.40	.97	1/2
5/16	1-6	2.60	2.10	1.50	5/8
3/8	1-8	3.70	3.00	2.20	3/4
7/16	1-10	5.00	4.10	2.90	1
1/2	2-0	6.60	5.40	3.80	1
9/16	2-2	8.30	6.80	4.80	1 1/4
5/8	2-4	10.00	8.30	5.90	1 1/4
3/4	2-9	15.00	12.00	8.40	1 1/2
7/8	3-3	20.00	16.00	11.00	1 3/4
1	3-6	26.00	21.00	15.00	2
1 1/8	4-0	31.00	26.00	18.00	2
1 1/4	4-6	38.00	31.00	22.00	2 1/4
1 3/8	5-0	46.00	38.00	27.00	2 1/2
1 1/2	5-6	55.00	45.00	32.00	2 3/4
1 5/8	6-0	63.00	52.00	37.00	2 3/4
1 3/4	6-6	74.00	60.00	42.00	3
2	8-0	95.00	78.00	55.00	3 1/2
2 1/4	8-9	116.00	94.00	67.00	4
2 1/2	10-0	141.00	115.00	82.00	4 1/2

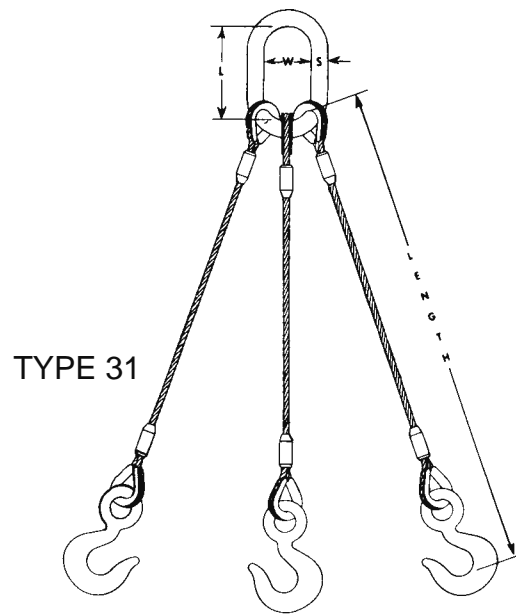

TYPE 31

3

For approximate capacities using Fibre Core EIPS: deduct 10% from EIPS-IWRC strengths.
 For approximate capacities on Hand Braided Slings: deduct 15% from corresponding mechanically swaged strengths.
 For approximate capacities on Socket Attachments: add 5% to corresponding IWRC swaged strengths.

Diam. Of Wire Rope Inches	Standard Loop Inside		Heavy Duty Thimble Inside		Alloy Hook Size-Tons For EIPS	Carbon Shackle Size-Inches For EIPS	Half Thimble Inside Loop		Open Swage Socket		Closed Swage Socket	
	Width Inches	Length Inches	Width Inches	Length Inches			Width Inches	Length Inches	Pin Diam. Inches	Jaw Opening Inches	Hole Diam. Inches	Head Thickness Inches
6 × 19 With IWRC												
1/4	2	4	7/8	1 5/8	1	5/16	—	—	11/16	11/16	3/4	1/2
5/16	2 1/2	5	1 1/16	1 7/8	1 1/2	3/8	—	—	13/16	13/16	7/8	11/16
3/8	3	6	1 1/8	2 1/8	2	7/16	2	4	13/16	13/16	7/8	11/16
7/16	3 1/2	7	1 1/4	2 3/8	3	1/2	2 1/4	5	1	1	1 1/16	7/8
1/2	4	8	1 1/2	2 3/4	4 1/2	5/8	2 1/4	5 1/2	1	1	1 1/16	7/8
9/16	4 1/2	9	1 1/2	2 3/4	4 1/2	5/8	2 1/4	5 1/2	1 3/16	1 1/4	1 1/4	1 1/8
5/8	5	10	1 3/4	3 1/4	7	3/4	3 1/4	7	1 3/16	1 1/4	1 1/4	1 1/8
3/4	6	12	2	3 3/4	11	7/8	3 1/4	9	1 3/8	1 1/2	1 7/16	1 5/16
7/8	7	14	2 1/4	4 1/4	11	1	4 1/2	10 1/2	1 5/8	1 3/4	1 11/16	1 1/2
1	8	16	2 1/2	4 1/2	15	1 1/4	4 1/2	12	2	2	2 1/16	1 3/4
1 1/8	9	18	2 7/8	5 1/8	22	1 1/4	4 5/8	13 1/2	2 1/4	2 1/4	2 5/16	2
6 × 37 with IWRC												
1 1/4	10	20	2 7/8	5 1/8	22	1 1/2	5 1/2	15	2 1/2	2 1/2	2 9/16	2 1/4
1 3/8	11	22	3 1/2	6 1/4	30	1 3/4	6	17	2 1/2	2 1/2	2 9/16	2 1/4
1 1/2	12	24	3 1/2	6 1/4	30	1 3/4	6 1/2	18	2 3/4	3	2 13/16	2 1/2
1 5/8	13	26	4	8	30	1 3/4	6 1/2	18	3 1/2	3 1/2	3 9/16	3
1 3/4	14	28	4 1/2	9	37	2	7	21 1/2	3 1/2	3 1/2	3 9/16	3
2	16	32	6	12	60	2 1/2	7	24 1/2	3 3/4	4	3 13/16	3 1/4
2 1/4	18	36	7	14	60	2 1/2	8 1/2	25 1/2	4 1/4	4 1/4	4 5/16	4
2 1/2	20	40	—	—	—	3	8 1/2	26 1/2	4 1/4	4 1/4	4 5/16	4
2 3/4						3						
3						3						
3 1/4						3 1/2						
3 1/2						3 1/2						
3 3/4						4						
4						4						



Type 41 Slings

FLEMISHED EYE & MECHANICALLY SWAGED

Type 41 slings are 4-leg All Purpose bridles, used both for balanced and unbalanced loads and for heavier loads where design calls for more distribution of weight by the use of attachment calls at four points.

Diam. Of Wire Rope Inches	Min.. Length (SL) Of Sling Ft.-In.	Rated Capacities in Tons EIPS-IWRC*			Alloy Oblong Links Diam. Inches
		60°	45°	30°	
1/4	1-3	2.20	1.80	1.30	5/8
5/16	1-6	3.50	2.80	2.00	3/4
3/8	1-8	5.00	4.10	2.90	7/8
7/16	1-10	6.70	5.50	3.90	1
1/2	2-0	8.80	7.10	5.10	1 1/4
9/16	2-2	11.00	9.00	6.40	1 1/2
5/8	2-4	14.00	11.00	7.80	1 3/4
3/4	2-9	19.00	16.00	11.00	2
7/8	3-3	26.00	21.00	15.00	2 1/4
1	3-6	34.00	28.00	20.00	2 1/2
1 1/8	4-0	42.00	34.00	24.00	2 3/4
1 1/4	4-6	51.00	42.00	30.00	3
1 3/8	5-0	62.00	50.00	36.00	3 1/4
1 1/2	5-6	73.00	60.00	42.00	3 1/2
1 5/8	6-0	85.00	69.00	49.00	3 3/4
1 3/4	6-6	98.00	80.00	57.00	4
2	8-0	127.00	104.00	73.00	4 1/2
2 1/4	8-9	154.00	126.00	89.00	Call
2 1/2	10-0	188.00	154.00	109.00	Call

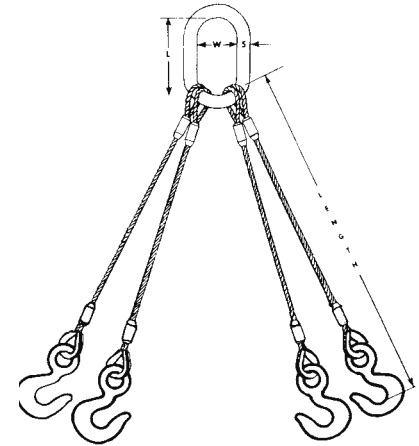

TYPE 41

3

For approximate capacities using Fiber Core EIP: deduct 10% from EIP-IWRC strengths.
 For approximate capacities on Hand Braided Slings: deduct 15% from corresponding mechanically swaged strengths.
 For approximate capacities on Socket Attachments: add 5% to corresponding IWRC swaged strengths.

* These ratings refer to an evenly balanced load between the four legs.
 In most instances, the ratings for a 3-leg sling should be used to accommodate for an unevenly balanced load.

Diam. Of Wire Rope Inches	Standard Loop Inside		Heavy Duty Thimble Inside		Alloy Hook Size-Tons For EIPS	Carbon Shackle Size-Inches For EIPS	Half Thimble Inside Loop		Open Swage Socket		Closed Swage Socket	
	Width Inches	Length Inches	Width Inches	Length Inches			Width Inches	Length Inches	Pin Diam. Inches	Jaw Opening Inches	Hole Diam. Inches	Head Thickness Inches
6 x 19 With IWRC												
1/4	2	4	7/8	1 5/8	1	5/16	—	—	1 1/16	1 1/16	3/4	1/2
5/16	2 1/2	5	1 1/16	1 7/8	1 1/2	3/8	—	—	1 3/16	1 3/16	7/8	1 1/16
3/8	3	6	1 1/8	2 1/8	2	7/16	2	4	1 3/16	1 3/16	7/8	1 1/16
7/16	3 1/2	7	1 1/4	2 3/8	3	1/2	2 1/4	5	1	1	1 1/16	7/8
1/2	4	8	1 1/2	2 3/4	4 1/2	5/8	2 1/4	5 1/2	1	1	1 1/16	7/8
9/16	4 1/2	9	1 1/2	2 3/4	4 1/2	5/8	2 1/4	5 1/2	1 3/16	1 1/4	1 1/4	1 1/8
5/8	5	10	1 3/4	3 1/4	7	3/4	3 1/4	7	1 3/16	1 1/4	1 1/4	1 1/8
3/4	6	12	2	3 3/4	11	7/8	3 1/4	9	1 3/8	1 1/2	1 7/16	1 5/16
7/8	7	14	2 1/4	4 1/4	11	1	4 1/2	10 1/2	1 5/8	1 3/4	1 1 1/16	1 1/2
1	8	16	2 1/2	4 1/2	15	1 1/4	4 1/2	12	2	2	2 1/16	1 3/4
1 1/8	9	18	2 7/8	5 1/2	22	1 1/4	4 3/8	13 1/2	2 1/4	2 1/4	2 5/16	2
6 x 37 with IWRC												
1 1/4	10	20	2 7/8	5 1/8	22	1 1/2	5 1/2	15	2 1/2	2 1/2	2 9/16	2 1/4
1 3/8	11	22	3 1/2	6 1/4	30	1 3/4	6	17	2 1/2	2 1/2	2 9/16	2 1/4
1 1/2	12	24	3 1/2	6 1/4	30	1 3/4	6 1/2	18	2 3/4	3	2 13/16	2 1/2
1 5/8	13	26	4	8	30	1 3/4	6 1/2	18	3 1/2	3 1/2	3 9/16	3
1 3/4	14	28	4 1/2	9	37	2	7	21 1/2	3 1/2	3 1/2	3 9/16	3
2	16	32	6	12	60	2 1/2	7	24 1/2	3 3/4	4	3 13/16	3 1/4
2 1/4	18	36	7	14	60	2 1/2	8 1/2	25 1/2	4 1/4	4 1/4	4 5/16	4
2 1/2	20	40	—	—	—	3	8 1/2	26 1/2	4 1/4	4 1/4	4 5/16	4
2 3/4						3						
3						3						
3 1/4						3 1/2						
3 1/2						3 1/2						
3 3/4						4						
4						4						



Type 12 Slings

CABLE-LAID: GALVANIZED

Cable-Laid slings are specialized slings, designed specifically for applications that require extreme flexibility, resistance to kinking. Type 12 is a single-leg construction for use singularly or in pairs. Where cutting abrasion or extreme conditions are factors, however, the All-Purpose Type 11 sling is recommended.

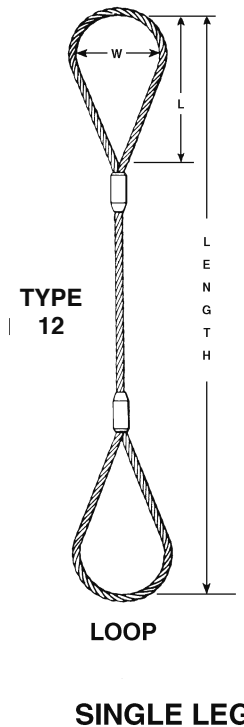

Diam of Rope Inches	Min. Length (SL) of Sling ft—in.	Inside Loop Dimensions W L in. in.		Rated Capacities in Tons (2000 lb)				
				** Choker Hitch	Single Part Vertical	Basket Hitch when used* @		
						60°	45°	30°
7 × 7 × 7								
3/8	2	3	6	0.8	1.1	1.9	1.5	1.1
1/2	2—6	4	8	1.3	1.9	3.2	2.6	1.9
5/8	3	5	10	1.9	2.8	4.8	3.9	2.8
7 × 7 × 19								
3/4	3—6	6	12	2.8	4.1	7.0	5.8	4.1
7/8	4	7	14	3.8	5.4	9.3	7.6	5.4
1	4—6	8	16	4.8	6.9	12	9.7	6.9
1 1/8	5	9	18	5.8	8.3	14	12	8.3
1 1/4	5—6	10	20	6.9	9.9	17	14	9.9

PERTINENT DIMENSIONS FOR END FITTINGS

Rope Diam. Inches	LOOP		THIMBLE		ALLOY HOOK Size Tons	SHACKLE with thimble Size In.	HALF THIMBLE	
	INSIDE		INSIDE				INSIDE LOOP	
	Width In.	Length In.	Width In.	Length In.			Width In.	Length In.
7 × 7 × 7								
3/8	3	6	1 1/8	2 1/8	1 1/2	7/16	2	4
1/2	4	8	1 1/2	2 3/4	3	1/2	2 1/4	5
5/8	5	10	1 3/4	3 1/4	4 1/2	5/8	3 1/4	5 1/2
7 × 7 × 19								
3/4	6	12	2	3 3/4	7	3/4	3 1/4	7
1	8	16	2 1/2	4 1/2	11	1	4 1/2	9
1 1/8	9	18	2 7/8	5 1/8	11	1 1/8	4 5/8	10 1/2
1 1/4	10	20	3 1/2	6 1/2	15	1 3/8	6	12

* Rated capacities of basket hitches are based on a minimum diameter of curvature at the point of load contact of 10 times the rope diameter.

** Rated capacities for choker hitches apply when the angle of choke is greater than 135°.

Bright 7 X 6 x 19 with IWRC Class Rope may be used on larger sizes. Capacities will differ.



Braided Slings Type 16

6-PART FLAT BODY

**TYPE 16
(WITH SERVED LOOPS)**

**TYPE 16
(WITH CRESCENT THIMBLES)**

**TYPE 16
(WITH SLIP-THRU THIMBLES)**

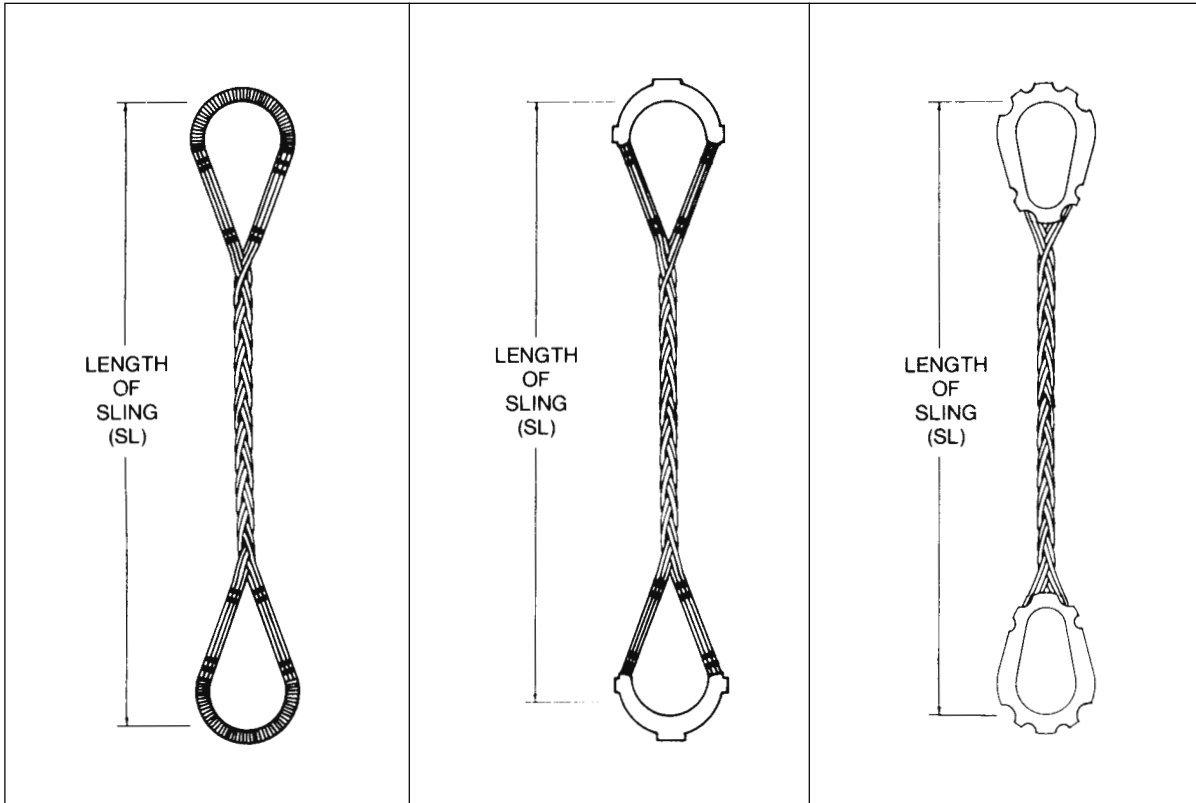

3

Diam* of Indi- vidual Ropes in.	Min Length (SL) of Slings ft.—in.	Rated Capacities in Tons of 2000 lb						Lengths of Loops		Slip- Thru Thim- bles Size No.	Crescent Thim- bles Size No.
		EIPS Rope—IWRC						Sug- gested L in.	Min. L in.		
		**** Choker Hitch	Single Leg Vertical	Basket Hitch*							
1/8	1—6	0.53	0.71	1.2	1.0	0.71	6	6	W-2	6C	
3/16	2—0	1.3	1.4	2.5	2.2	1.4	8	6	W-3	8C	
1/4	2—6	2.2	2.5	4.4	3.6	2.5	12	8	W-4	9C	
5/16	2—9	3.4	3.9	6.8	5.0	3.9	12	8	W-4	10C	
3/8	3—6	4.9	5.6	9.8	8.0	5.6	16	10	W-5	14C	
7/16	4—0	6.7	7.6	13	11	7.6	18	12	W-5	16C	
1/2	4—6	8.7	9.9	17	14	9.9	18	12	W-5	18C	
9/16	5—6	11	12	22	18	12	20	14	W-6	20C	
5/8	6—6	14	15	27	22	15	24	18	W-7	22C	
3/4	7—6	19	22	38	31	22	28	20	W-7	24C	
7/8	8—9	26	30	52	42	30	32	24	W-8	32C	
1	10—6	34	39	67	55	39	36	30	W-9	40C	

* Larger sizes available upon request.

Rated capacities basket hitch based on D/d ratio of 25 times the component rope diameter.

Rated capacities based on pin diameter no larger than natural eye width or less than the nominal sling diameter.

Rated capacities based on design factor of 5.

Horizontal sling angles less than 30 degrees shall not be used.

** Rated capacities of choker hitches apply when the angle of choke is greater than 135°.

Available in Galvanized Aircraft Cable up to 3/8" ropes.



Type 18 Slings

8-PART BRAIDED

Diameter of Individual Ropes Inches	Diameter of Sling Body Inches	Min. Length (SL) of Sling ft—in.	Rated Capacities**						Inside Loop Dimensions Approx.	
			Single Leg Vertical	** Choker Hitch	Basket Hitch*				W in.	L in.
					Straight Pull Vertical	60°	45°	30°		
* 3/32	7/16	1—5	.59	.44	1.18	1.00	.83	.59	2	4
* 1/8	9/16	1—10	1.10	.82	2.20	1.90	1.50	1.10	3	6
* 3/16	13/16	2—10	2.20	1.80	4.30	4.30	3.00	2.20	5	10
* 1/4	1 1/8	3—6	3.80	3.30	7.60	6.60	5.40	3.80	6	12
* 5/16	1 3/8	4—6	5.90	5.20	12.00	10.00	8.30	5.90	8	16
* 3/8	1 11/16	5—0	8.50	7.40	17.00	15.00	12.00	8.50	8	16
7/16	2	5—9	11.00	10.00	23.00	20.00	16.00	11.00	9	18
1/2	2 1/4	6—5	15.00	13.00	30.00	26.00	21.00	15.00	9	18
9/16	2 1/2	8—0	19.00	16.00	38.00	33.00	27.00	19.00	12	24
5/8	2 13/16	9—4	23.00	20.00	46.00	40.00	33.00	23.00	14	28
3/4	3 3/8	—	33.00	29.00	66.00	57.20	47.85	33.20	—	—
7/8	4	—	45.00	39.00	89.00	77.60	63.80	45.55	—	—
1	4 1/2	—	58.00	51.00	116.00	100.60	82.35	58.35	—	—
1 1/8	5	—	73.00	64.00	146.00	126.00	103.00	73.00	—	—
1 1/4	5 5/8	—	89.00	78.00	179.00	155.00	127.00	89.00	—	—
1 3/8	6 3/16	—	108.00	94.00	215.00	186.00	152.00	108.00	—	—
1 1/2	6 3/4	—	128.00	112.00	255.00	221.00	181.00	128.00	—	—
1 5/8	7 5/16	—	148.00	129.00	296.00	256.00	209.00	148.00	—	—
1 3/4	7 7/8	—	171.00	150.00	343.00	297.00	242.00	171.00	—	—
1 7/8	8 7/16	—	195.00	171.00	390.00	338.00	276.00	195.00	—	—
2	9	—	222.00	194.00	444.00	384.00	314.00	222.00	—	—

Larger sizes available.

* Galvanized Aircraft Cable may be used on Individual Ropes up to 3/8" Dia.

** Rated capacities are given in tons of 2000 lb using EIPS rope with IWRC. Rated capacities of basket hitches are based on minimum diameter of curvature at the point of load contact of 20 times the rope diameter.

*** Rated capacities of choker hitches apply when the angle of choke is greater than 135°.

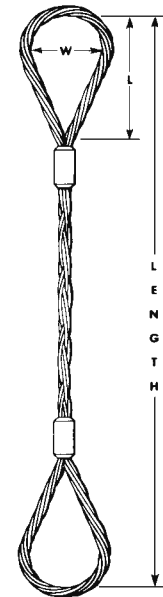

TYPE 18

3

PERTINENT DIMENSIONS FOR END FITTINGS

Sling Size Inches	LOOP		SLIP-THRU THIMBLE		ALLOY HOOK	SHACKLE with Thimble	HALF THIMBLE	
	INSIDE		INSIDE				INSIDE LOOP	
	Width In.	Length In.	Width In.	Length In.	Size Tons	Size In.	Width In.	Length In.
3/32	1 1/2	3	2 1/8	4 1/8	1	1/4		
1/8	2	4	2 1/8	4 1/8	1 1/2	3/8	2	4
3/16	3	6	2 3/8	4 3/8	3	1/2	2 1/4	6
1/4	4	8	3 3/8	6 5/8	4 1/2	5/8	3 1/4	8
5/16	5	10	3 3/4	7 1/8	7	3/4	4 1/2	10
3/8	6	12	3 3/4	7 1/8	11	7/8	4 5/8	12
7/16	7	14	4 3/8	8 3/8	15	1 1/8	5 1/2	14
1/2	8	16	5	9 1/2	15	1 1/4	6	16
9/16	9	18	5	9 1/2	22	1 1/2	6 1/2	18
5/8	10	20	6 3/4	11 3/4	30	1 3/4	7	20
3/4	12	24	8	14 1/2	37	2	8	24
7/8	14	28	8 3/8	17 5/8	45	2		
1	16	32	8 3/8	17 5/8	60	2 1/8		



Type 18 Braided Slings

8-PART FLAT BODY ERECTOR SLINGS

8-PART ROUND BODY ERECTOR SLINGS

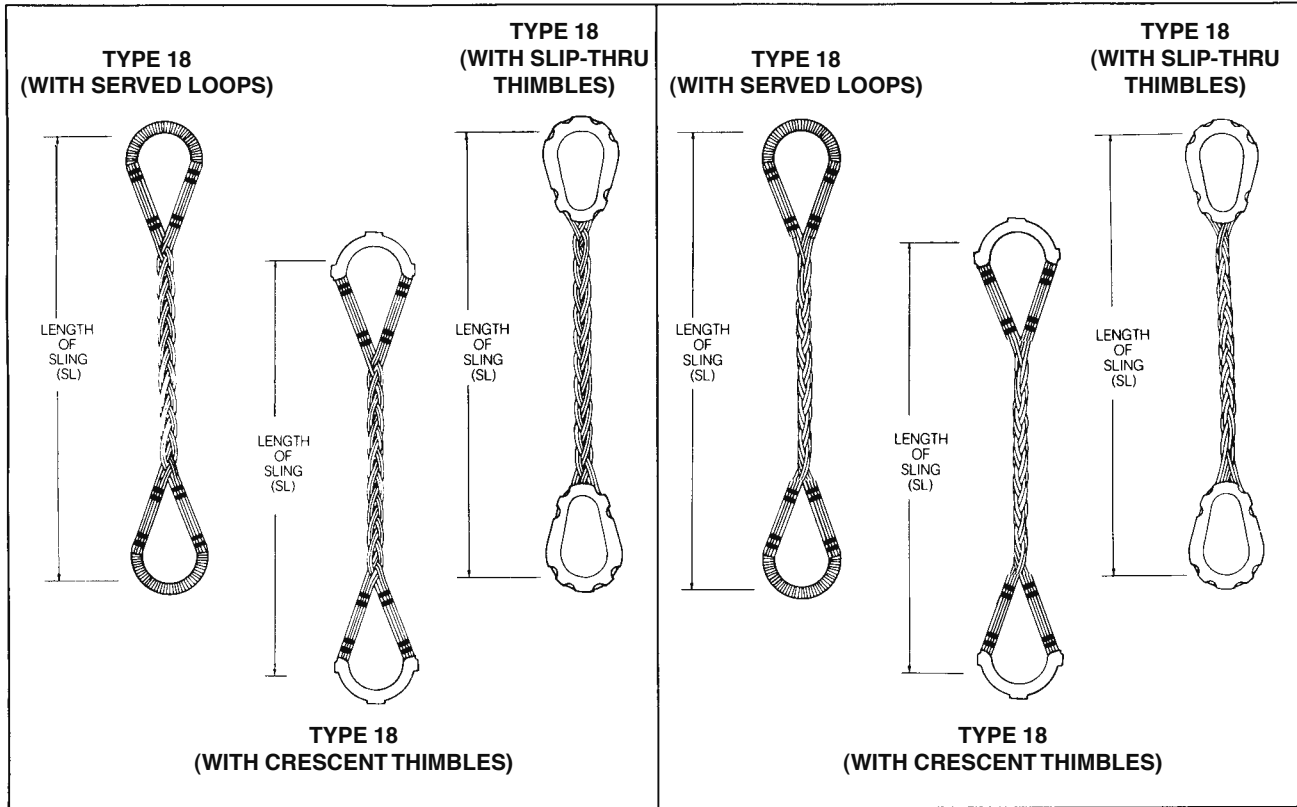

3

Diam. of Individual Ropes in.	Min. Length (SL) of Sling ft.—in.	Rated Capacities in Tons (2000 lb)										Lengths of Loops		Thimbles	
		EIPS—Fiber Core					EIPS—IWRC								
		** Choker Hitch	Single Leg Vertical	Basket Hitch*			** Choker Hitch	Single Leg Vertical	Basket Hitch*			Sug-gested L in.	Min L in.	Slip-Thru Thimbles Size No.	Crescent Thimbles Size No.
				60°	45°	30°			60°	45°	30°				
1/8	1—6	—	—	—	—	—	1	1.1	1.9	1.6	1.1	6	6	W-2	8C
3/16	2—0	1.7	1.9	3.3	2.7	1.9	1.9	2.2	3.7	3.0	2.2	10	6	W-3	9C
1/4	2—6	3.0	3.4	5.8	4.8	3.4	3.3	3.8	6.6	5.4	3.8	12	8	W-4	10C
5/16	2—9	4.6	5.2	9.1	7.4	5.2	5.2	5.9	10	8.3	5.9	16	8	W-5	14C
3/8	3—6	6.6	7.5	13	11	7.5	7.4	8.5	15	12	8.5	16	10	W-5	16C
7/16	4—0	8.9	10	18	14	10	10	11	20	16	11	18	12	W-6	18C
1/2	4—6	12	13	23	19	13	13	15	26	21	15	18	12	W-7	20C
9/16	5—6	15	17	29	24	17	16	19	33	27	19	24	14	W-7	22C
5/8	6—6	18	21	36	29	21	20	23	40	33	23	28	18	W-8	24C
3/4	7—6	26	29	51	41	29	29	33	57	47	33	30	20	W-9	28C
7/8	8—9	35	40	69	56	40	39	45	77	63	45	36	24	W-10	32C
1	10—6	45	51	89	73	51	51	58	100	82	58	48	30	W-10	40C
1 1/8	12—6	57	65	112	92	65	64	73	126	103	73	60	36	W-11	48C
1 1/4	15—0	70	80	138	113	80	78	89	155	127	89	72	42	W-11	—
1 3/8	18—8	84	96	166	135	96	94	108	186	152	108	84	54	—	—

* NOTE: 1/8 utilize Galvanized Small Cord minimum breakage force.
 Rated capacities basket hitch based on D/d ratio of 25 times the component rope diameter.
 Rated capacities based on pin diameter no larger than natural eye width or less than the nominal sling diameter.
 Rated capacities based on design factor of 5.

Horizontal sling angles less than 30 degrees shall not be used.
 ** Rated capacities of choker hitches apply when the angle of choke is greater than 135°.
 Also available made from Galvanized Aircraft Cable.
 Larger sizes available.



Braided Slings Type 19

Helically laid with one continuous wire rope running through both eyes and the body

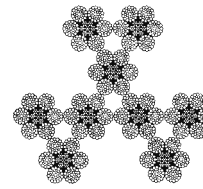

Cross Section Through Body



Flexibility and handing ease for rigging large lifts is achieved in these 9-part slings by laying a single wire rope continuously through both eyes and the sling body so that nine parts of rope form the body. This proven design provides internal adjustment to distribute the load evenly among all nine parts of the body when a sling is in tension. In addition, the construction makes it possible to visually inspect all internal parts of the sling before and after each lift – important when a sling is to be used many times. Only two splices occur in the entire sling, where the two rope ends are spliced at the eyes.

A 9-part sling construction exhibits constructional stretch of approximately 1 1/2% on the first loading, and a lesser amount thereafter. For this reason, lifts using two or more legs should always be made with legs which have been subjected to the same past usage when such stretch may affect the lift.

Where a sling body must conform to a tight choke hitch, or must bend in a tight radius, as around a pin or post, a 9-part construction may be the most suitable, since it can develop greater lifting capacity from a smaller component rope.



Conforms with WRTB Publication "Wire Rope Sling Users Manual".

**9-PART BRAID
HAND TUCKED SPLICE
IWRC**

VERTICAL, CHOKER OR VERTICAL BASKET

RATED CAPACITY IN TONS OF 2,000 lbs.

RATED CAPACITIES SHOWN APPLY ONLY TO 6X19 AND 6X36 CLASSIFICATION WIRE ROPE

ROPE DIAMETER (INCHES)	VERTICAL		CHOKER		VERTICAL BASKET	
						
	IPS	EIPS	IPS	EIPS	IPS	EIPS
3/32*	0.63		0.55		1.3	
1/8*	1.3		1.1		2.5	
3/16	2.1	2.4	1.8	2.1	4.2	4.8
1/4	3.7	4.3	3.2	3.7	7.4	8.6
5/16	5.8	6.6	5.0	5.8	12	13
3/8	8.3	9.5	7.2	8.3	17	19
7/16	11	13	9.8	11	22	26
1/2	14	17	13	15	29	34
9/16	18	21	16	19	37	42
5/8	23	26	20	23	45	52
3/4	32	37	28	32	65	74
7/8	44	50	38	44	87	100
1	57	65	50	57	113	130
1 1/8	71	82	62	72	142	164
1 1/4	87	101	77	88	175	201
1 3/8	105	121	92	106	210	242
1 1/2	125	144	109	126	249	287
1 5/8	145	166	127	146	290	333
1 3/4	168	193	147	169	335	386
1 7/8	192	219	168	192	383	438
2	217	249	190	218	433	499

* NOTE: 3/32 & 1/8 utilize Galvanized Small Cord minimum breaking force.

Rated capacities basket hitch based on D/d ratio of 25 times the component rope diameter.
 Rated capacities based on pin diameter no larger than natural eye width or less than the nominal sling diameter.
 Rated capacities based on design factor of 5
 Horizontal sling angles less than 30 degrees shall not be used.

Choker Slings

Braided Slings

TYPE 18

CHOKER HITCH RATING

Diameter of Ropes in Braided Sling Inches	Rated Capacities** in Tons (2000 lb)		Slip-Thru Thimbles Size No.	Choker Hooks Size No.
	EIPS Fiber Core	EIPS IWRC		
1/8	—	1.0	W-2	2
3/16	2.7	1.9	W-3	3
1/4	3.6	3.3	W-4	4
5/16	4.6	5.2	W-5	5
3/8	6.6	7.4	W-5	6
7/16	8.9	10	W-6	7
1/2	12	13	W-7	8

** Rated capacities of basket hitches are based on a minimum diameter of curvature at the point of load contact of 25 times the component rope diameter.

Rated capacities of choker hitches apply when the angle of choke is greater than 135°.

3

Flemished Eye & Mechanically Swaged

Diameter of Individual Ropes Inches	Rated Capacities** in Tons (2000 lb)		Slip-Thru Thimbles Size No.	Spliced Loops		Sliding Choker Hooks	
	EIPS Fiber Core	EIPS IWRC		W in.	L in.	Size No.	Weight lbs
1/4	.42	.48	W-2	2	2	1/4 - 5/16	1.0
3/8	.94	1.1	W-2	3	3	3/8	0.8
1/2	1.6	1.9	W-3	4	4	1/2	1.25
5/8	2.6	2.9	W-4	5	5	5/8	2.5
3/4	3.7	4.1	W-4	6	6	3/4	4.5
7/8	5.8	5.6	W-5	7	7	7/8 - 1	10
1	6.4	7.2	W-5	8	8	7/8 - 1	10
1 1/8	8.1	9	W-6	9	9	1 1/8 - 1 1/4	26
1 1/4	9.9	11	W-6	10	10	1 1/8 - 1 1/4	26
1 3/8	12	13	W-7	11	11	1 3/8 - 1 1/2	42
1 1/2	14	16	W-7	12	12	1 3/8 - 1 1/2	42

* When ordered (no HT): Bottom Eye will be supplied standard size (with no thimble).

** Rated capacities of choker hitches apply when the angle of choke is greater than 135°.



Choker Slings

TAPERED SLEEVE ATTACHMENTS

These Choker Slings are designed to grip or choke the load. Ideally suited to lifting bar stock, beams, lumber, bundles of pipe and similar material. The tapered sleeve splice, as well as the anchor hitch on Type 61, allows close snubbing of the load, insuring a positive grip.

The use of sliding choker hooks on Type 21 increases sling life and permits faster handling.

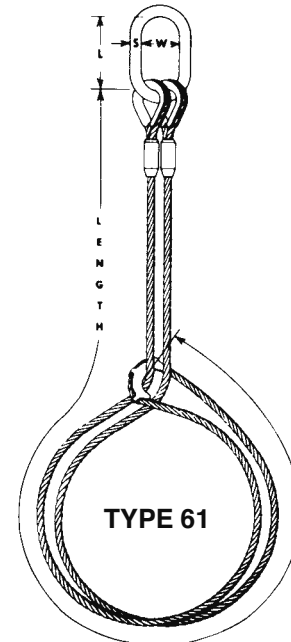

For Ratings on Type 61 shown above call IRSCI.

TWO LEG BRIDLE CHOKER SLING - TYPE 21

TYPE 21

Diameter of Wire Rope Inches	Rated Capacities* in Tons (2000 lb) EIPS IWRC** When Used @			Sliding Choker Hooks		Alloy Oblong Links d in.
	60°	45°	30°	Size	Wt. lb.	
3/8	1.8	1.5	1.1	3/8	.8	1/2
1/2	3.2	2.6	1.9	1/2	1.25	3/4
5/8	5.0	4.1	2.9	5/8	2.5	7/8
3/4	7.1	5.8	4.1	3/4	4.5	1
7/8	9.7	7.9	5.6	7/8-1	8	1 1/8
1	13	10	7.2	7/8-1	8	1 1/2
1 1/8	16	13	9.1	1 1/8-1 1/4	26	1 1/2
1 1/4	19	16	11	1 1/8-1 1/4	26	1 3/4
1 3/8	23	19	13	1 3/8-1 1/2	42	2
1 1/2	28	23	16	1 3/8-1 1/2	42	2

*Rated capacities are based on minimum diameter of curvature at the point of load contact of 25 times the rope diameter. Rated capacities of choker hitches apply when the angle of choke is greater than 135°.

**Information on EEIPS ropes and fitting sizes with higher rated capacities is available on request.



Grommet Slings

Mechanically Spliced

TYPE 53 STRAND-LAID CONSTRUCTION

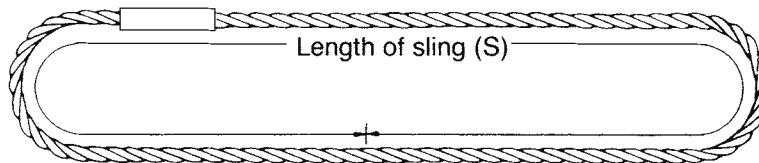

Diam. of Grommet Inches	Rated Capacities in Tons (2000 lb) EIPS				
	Choker Hitch	Leg Vertical	Basket Hitch When Used		
			30°	45°	60°
3/8	1.6	2.4	4.1	3.3	2.4
1/2	2.9	4.1	7.2	5.9	4.1
5/8	4.5	6.4	11	9.1	6.4
3/4	6.4	9.2	16	13	9.2
7/8	8.7	12	22	18	12
1	11	16	28	23	16

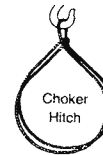
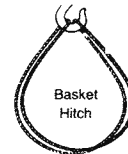

Larger sizes available upon request
 Rated capacities basket hitch and vertical lift based on D/d ratio of 5 where "d" = body diameter of the finished grommet
 Rated capacities based on design factor of 5.
 Rated capacities based on pin diameter no smaller than 5 times the body diameter.
 Horizontal sling angles less than 30 degrees shall not be used.
 Length of sling (SL) is measured as indicated on sketch.
 Rated capacities of choker hitches apply when the angle of choke is greater than 120°.

3

TYPE 54 FLEXIBLE GROMMET SLINGS CABLE-LAID CONSTRUCTION

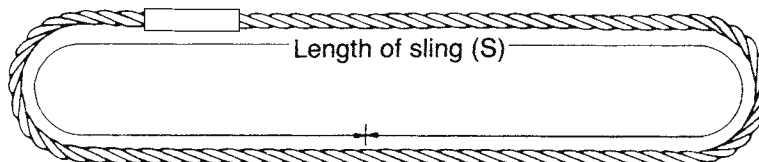

Diam. of Grommet Inches	Construction of Grommet	Rated Capacities in Tons (2000 lb) EIPS				
		Choker Hitch	Leg Vertical	Basket Hitch When Used		
				30°	45°	60°
3/8	7 x 7 x 7	1.2	1.8	3.1	2.5	1.8
1/2	7 x 7 x 7	2.0	3.0	5.3	4.3	3.0
5/8	7 x 7 x 7	3.0	4.6	7.9	6.4	4.6
3/4	7 x 6 x 19	4.1	6.2	11	8.8	6.2
1	7 x 6 x 19	6.8	11	18	15	11

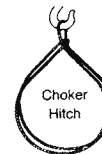
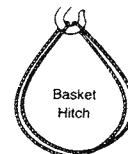

Larger sizes available upon request
 Rated capacities basket hitch and vertical lift based on D/d ratio of 5 where "d" = body diameter of the finished grommet
 Rated capacities based on design factor of 5.
 Rated capacities based on pin diameter no smaller than 5 times the body diameter.
 Horizontal sling angles less than 30 degrees shall not be used.
 Length of sling (SL) is measured as indicated on sketch.
 Rated capacities of choker hitches apply when the angle of choke is greater than 120°.



Grommet Slings

Hand Tucked

TYPE 51 STRAND-LAID CONSTRUCTION

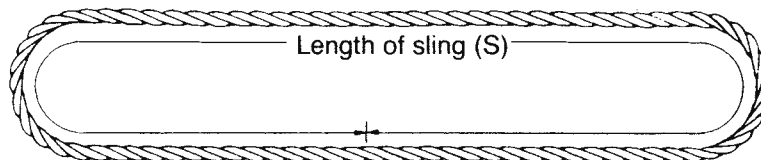

Diam. of Grommet Inches	Rated Capacities in Tons (2000 lb) EIPS				
	Choker Hitch	Leg Vertical	Basket Hitch When Used		
			30°	45°	60°
3/8	1.5	2.1	3.6	3.0	2.1
1/2	2.6	3.7	6.4	5.2	3.7
5/8	4.0	5.7	9.9	8.1	5.7
3/4	5.7	8.2	14	12	8.2
7/8	7.7	11	19	16	11
1	10	14	25	20	14

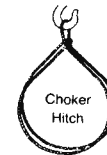
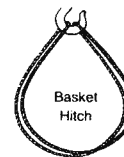

Larger sizes available on request.
Length of sling (SL) is measured as indicated on sketch.
Rated capacities of choker hitches apply when the angle of choke is greater than 120°.

3

TYPE 52 FLEXIBLE GROMMET SLINGS CABLE-LAID CONSTRUCTION

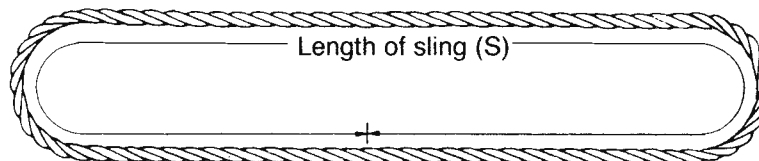

Diam. of Grommet Inches	Diam. of Rope Used inches	Construction of Grommet	Rated Capacities in Tons (2000 lb) EIPS				
			Choker Hitch	Leg Vertical	Basket Hitch When Used		
					30°	45°	60°
3/8	1/8	7 x 7 x 7	1.2	1.6	2.8	2.3	1.6
9/16	3/16	7 x 7 x 7	2.0	3.5	6.0	4.9	3.5
5/8	7/32	7 x 7 x 7	3.0	4.5	7.8	6.4	4.5
3/4	1/4	7 x 6 x 19	4.1	5.6	9.7	7.9	5.6
15/16	5/16	7 x 6 x 19	6.8	8.7	15	12	8.7

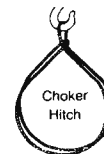
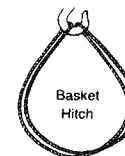

Larger sizes available on request.
Length of sling (SL) is measured as indicated on sketch.
Rated capacities of choker hitches apply when the angle of choker is greater than 120°.

Rated capacities basket hitch and vertical lift based on D/d ratio of 5 where "d" = body diameter of the finished grommet
Rated capacities based on design factor of 5.
Rated capacities based on pin diameter no smaller than 5 times the body diameter.
Horizontal sling angles less than 30 degrees shall not be used.

Chain





Alloy Chain Slings

HOW TO ORDER THE PROPER CHAIN SLING

When ordering, please be sure to include the following:

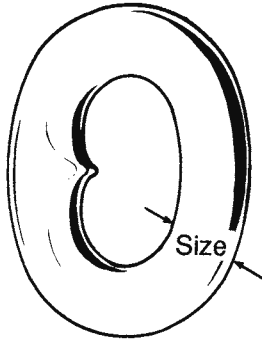

SIZE

Size means diameter of the material from which the link of the body chain is formed. Throughout this bulletin, size will be given in fractions.

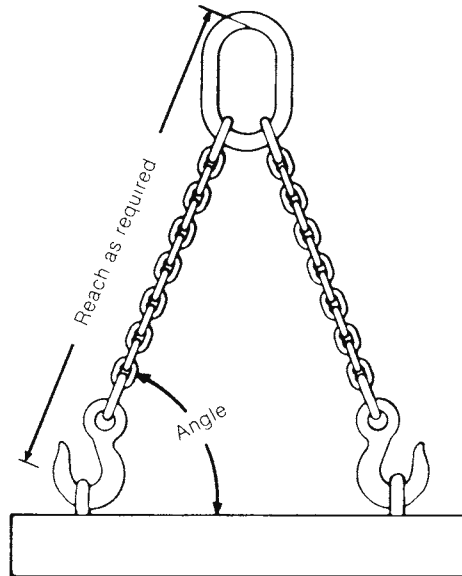

REACH("PULL TO PULL")

If chain slings are to be used in pairs and are to be matched for reach, please indicate when ordering.

TYPE

In describing the type of chain sling, the following symbols should be used. If attachments required are other than standard, give detailed specifications and description.

First symbol (basic type)

- S** — Single chain sling.
- C** — Single Choker chain sling with a standard end link on each end, no hooks.
- D** — Double branch chain sling.
- T** — Triple branch chain sling.
- Q** — Quadruple branch chain sling.

Second symbol (type of master link or end link)

- O** — Oblong master link of standard dimensions.
- P** — Pear-shaped master link (available on request, not a standard item).

Third symbol (type of hook)

- S** — Sling hook
- G** — Grab hook
- F** — Foundry hook
- L** — Latchlok
- PH** — Plate hook (available on request, not a standard item).
- PC** — Plate clamp (available on request, not a standard item).



Grade 80 & 100 Alloy Chain

GENERAL INFORMATION

WORKING LOAD LIMIT

The "Working Load Limit" is the maximum load in pounds which should ever be applied to chain, when the chain is new or "in as new" condition, and when the load is uniformly applied in direct tension to a straight length of chain.

PROOF TEST

The "Proof Test" is a term designating the tensile test applied to new chain for the sole purpose of detecting injurious defects in the material or manufacture. It is the load which the chain has withstood under a test in which the load has been applied in direct tension to a straight length of chain.

MINIMUM ULTIMATE LOAD

The "Minimum Ultimate Load" is the minimum load at which new chain will break when tested by applying direct tension to a straight length of chain at a uniform rate of speed in a testing machine.

ATTACHMENTS

Any attachments, such as hooks or links, should have a rated "Working Load Limit" at least equal to the chain with which it is used.

SYMMETRICAL LOADING

Rated Working Load Limit assumes symmetrical loading of all sling legs.

SPECIFICATIONS: ANSI / ASME B30.9 2006

Paragraph 9-1.6.1 "Prior to initial use, all new and repaired chain and components of an alloy steel chain sling, either individually or as an assembly, shall be proof tested by the sling manufacturer or qualified person."

CAUTION

Only Crosby Alloy chain, Spectrum 8® or Spectrum 10®, should be used for overhead lifting applications.

General Usage – It must be recognized that certain factors in the usage of chain and attachments can be abusive and lessen the load that the chain or attachments can withstand. Some examples are twisting of the chain; disfigurement; deterioration by straining, usage, weathering and corrosion; rapid application of load or jerking; applying excessive loads; sharp corner cutting action and non-symmetrical loading effects.

When using chain slings in choker applications, the Working Load Limit must be reduced by 20%. Crosby recommends a minimum angle of choke of 120 degrees. Consult Crosby when planning to use an angle of choke of less than 120 degrees. If Crosby A-1338 cradle grab hooks are used at a minimum angle of choke of 120 degrees, the full sling rated WLL can be utilized.



In shortening applications, a 20% reduction of the Working Load Limit is required except when using the Crosby A-1338 cradle grab hooks or S-1311N chain shortener link. They can be used without any reduction to the Working Load Limit.

Care should be taken to observe these derated applications or chain may fracture or permanently stretch at loads less than the advertised chain ultimate strength and proof load respectively.

Environmental Effects – Excessive high or low temperatures, or exposure to chemically active environments such as acids or corrosive liquids or fumes, can reduce the performance of the chain.

Temperature

- Extreme temperatures will reduce the performance of alloy steel chain slings.
- Normal operating temperature is -40° F to 400° F (-40° C to 204° C).
- See the temperature exposure chart (Table 1) to determine reduction of WLL due to operation at, and exposure to, elevated temperatures.

Chemically Active Environments can have detrimental effects on the performance of chain. The effects can be both visible loss of material and undetectable material degradation causing significant loss of strength.

- Usage Exposure – Exposure to chemically active environments such as acids or corrosive liquids or fumes can reduce the performance of the chain.
- Special Surface Coating/Plating/Galvanizing – Chain should not be subjected to galvanizing, or any plating process.
- If it is suspected that the chain has been exposed to chemically active environment, remove from service.

Temperature of Chain		Grade 8 (80) Chain		Grade 10 (100) Chain	
(F°)	(C°)	Temporary Reduction of Rated Load at Elevated Temperature*	Permanent Reduction of Rated Load After Exposure to Temperature**	Temporary Reduction of Rated Load at Elevated Temperature*	Permanent Reduction of Rated Load After Exposure to Temperature**
Below 400	Below 204	None	None	None	None
400	204	10%	None	15%	None
500	260	15%	None	25%	5%
600	316	20%	5%	30%	15%
700	371	30%	10%	40%	20%
800	427	40%	15%	50%	25%
900	482	50%	20%	60%	30%
1000	538	60%	25%	70%	35%
Over 1000	Over 538	OSHA 1910.184 and ASME B30.9 requires all slings exposed to temperatures over 1000° F to be removed from service.			

* Crosby does not recommend the use of Alloy Chain at temperatures above 800° F.

** When chain is used at room temperature after being heated to temperatures shown in the first column.



Crosby® Grade 100 Chain Sling Configurations

TO MAKE YOUR CROSBY® GRADE 100 ALLOY CHAIN SLING

Follow these simple steps in making a sling assembly:

1. Determine the maximum load to be lifted by the sling assembly.
2. Choose the type of sling assembly suited for the shape of the load and the size of the sling assembly for the load to be lifted. The decision must take into account the angle of the sling legs in multileg slings.
3. Determine the overall reach from bearing point of master link to bearing point on hook (see Fig. 1).
4. Select components, assemble chain and components.
5. Affix sling identification tag to sling. The tag is available from your Authorized Crosby Distributor.



Fig. 1

Each sling shall be marked to show: name or trademark of manufacturer, grade, nominal chain size, number of legs, rated load for the type(s) of hitch(es) used and angle upon which it is based (reach).

If measurement comes in the link, cut the following link. For two leg type slings, count the links and use an even number

for clevis hooks and an odd number for eye hooks. This will position hooks in the same plane. In multileg slings always use the same number of links in each leg.

When using chain slings in choker applications, the Working Load Limit must be reduced by 20%. Crosby recommends a minimum angle of choke of 120 degrees. Consult Crosby when planning to use an angle of choke of less than 120 degrees. If Crosby A-1338 cradle grab hooks are used at a minimum angle of choke of 120 degrees, the full sling rated WLL can be utilized.



In shortening applications, a 20% reduction of the Working Load Limit is required except when using the Crosby A-1338 cradle grab hooks or S-1311N chain shortener link. They can be used without any reduction to the Working Load Limit.

The Slings shown here are standard assemblies that can be made from "Proof Tested" Crosby Components and Alloy Chain supplied by your authorized Crosby distributor. Assemblies must include chain sling identification tag (not shown).

TYPE CO	TYPE SOS	TYPE SOG	TYPE SOF	TYPE SSS	TYPE SGS	TYPE ASOS	TYPE ASOF	TYPE ASOG	TYPE SOCH
Type	Description				Type	Description			
CO	Single Chain Sling with Master Link each end				SGS	Single Chain Sling with Grab Hook and Sling Hook			
SOS	Single Chain Sling with Master Link and Sling Hook				ASOS	Adjustable Single Chain with Master Link and Sling Hook			
SOG	Single Chain Sling with Master Link and Grab Hook				ASOF	Adjustable Single Chain Sling with Master Link and Foundry Hook			
SOF	Single Chain Sling with Master Link and Foundry Hook				ASOG	Adjustable Single Chain Sling with Master Link and Grab Hook			
SSS	Single Chain Sling with Sling Hook each end				SOCH	Single with 1355 Choker			

TYPE DOS	TYPE DOG	TYPE DOF	TYPE ADOS	TYPE ADOG	TYPE DOCH
Type	Description			Type	Description
DOS	Double Chain Sling with Master Link and Sling Hook			ADOS	Adjustable Double Chain Sling with Master Link and Sling Hook
DOG	Double Chain Sling with Master Link and Grab Hook			ADOG	Adjustable Double Chain Sling with Master Link and Grab Hook
DOF	Double Chain Sling with Master Link and Foundry Hook			DOCH	Double with 1355 Choker

TYPE TOS	TYPE TOG	TYPE TOF	TYPE TOCH	TYPE QOS	TYPE QOG	TYPE QOF
Type	Description			Type	Description	
TOS	Triple Chain Sling with Master Link and Sling Hook			QOS	Quadruple Chain Sling with Master Link and Sling Hook	
TOG	Triple Chain Sling with Master Link and Grab Hook			QOG	Quadruple Chain Sling with Master Link and Grab Hook	
TOF	Triple Chain Sling with Master Link and Foundry Hook			QOF	Quadruple Chain Sling with Master Link and Foundry Hook	
TOCH	Triple with 1355 Choker					



Crosby ELIMINATOR®

TO ORDER YOUR CROSBY ELIMINATOR® GRADE 100 ALLOY CHAIN SLING

Follow these simple steps to order a sling assembly:

1. Determine the maximum load to be lifted by the sling assembly.
2. Choose the type of sling assembly suited for the shape of the load and the size of the sling assembly for the load to be lifted. The decision must take into account the angle of the sling legs in multileg slings.
3. Determine the overall reach from bearing point of Eliminator Bail to bearing point on hook (see Fig. 1).
4. Select components, assemble chain and components.
5. Affix sling identification tag to sling. The tag is available from your Authorized Crosby Distributor.



Fig. 1

which it is based (reach).

When using chain slings in choker applications, the Working Load Limit must be reduced by 20%. Crosby recommends a minimum angle of choke of 120 degrees. Consult Crosby when planning to use an angle of choke of less than 120 degrees. If Crosby A-1338 cradle grab hooks are used at a minimum angle of choke of 120 degrees, the full sling rated WLL can be utilized.



In shortening applications, a 20% reduction of the Working Load Limit is required except when using the Crosby ELIMINATOR® Shortener Link, S-1311N chain shortener link or the Crosby ELIMINATOR® Shortener Link. They can be used without any reduction to the Working Load Limit.

Each sling shall be marked to show: name or trademark of manufacturer, grade, nominal chain size, number of legs, rated load for the type(s) of hitch(es) used and angle upon



TYPE ESOS



TYPE ESOG



TYPE ESOL



TYPE ESOF

Type	Description	Type	Description
ESOS	Crosby ELIMINATOR® Single Chain Sling with Sling Hook	ESOL	Crosby ELIMINATOR® Single Chain with SHUR-LOC® Hook
ESOG	Crosby ELIMINATOR® Single Chain Sling with Grab Hook	ESOF	Crosby ELIMINATOR® Single Chain with Foundry Hook



TYPE EDOS



TYPE EDOG



TYPE EDOL



TYPE EDOF

Type	Description	Type	Description
EDOS	Crosby ELIMINATOR® Double Chain Sling with Sling Hooks	EDOL	Crosby ELIMINATOR® Double Chain with SHUR-LOC® Hooks
EDOG	Crosby ELIMINATOR® Double Chain Sling with Grab Hooks	EDOF	Crosby ELIMINATOR® Double Chain with Foundry Hooks

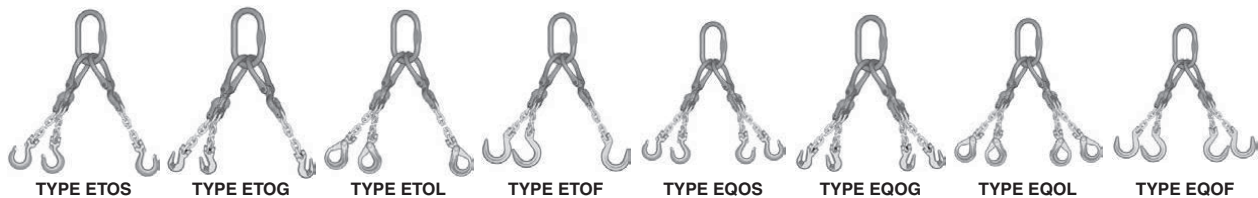

Type	Description	Type	Description
ETOS	Crosby ELIMINATOR® Triple Chain Sling with Master Link and Sling Hooks	EQOS	Crosby ELIMINATOR® Quad Chain Sling with Master Link and Sling Hooks
ETOG	Crosby ELIMINATOR® Triple Chain Sling with Master Link and Grab Hooks	EQOG	Crosby ELIMINATOR® Quad Chain Sling with Master Link and Grab Hooks
ETOL	Crosby ELIMINATOR® Triple Chain Sling with Master Link and SHUR-LOC® Hooks	EQOL	Crosby ELIMINATOR® Quad Chain Sling with Master Link and SHUR-LOC® Hooks
ETOF	Crosby ELIMINATOR® Triple Chain Sling with Master Link and Foundry Hooks	EQOF	Crosby ELIMINATOR® Quad Chain Sling with Master Link and Foundry Hooks



Grade 100 Assembly Chart

SINGLE LEG SLING

Spectrum 10 [®] Chain Size		Grade 100 Chain Stock No.	Master Link A-1342N + Stock No.	Master Link Assembly A-1345N + Stock No.	Master Link A-342 Stock No.	Master Link A-345 Stock No.	ELIMINATOR [®] L-1361 Stock No.	LOK-A-LOY [®] A-1337 Stock No.	Chain Coupler S-1325A Stock No.	Chain Shortener Link S-1311N Stock No.	SHUR-LOC [®] Clevis Hook S-1317 Stock No.	SHUR-LOC [®] Swivel Hook S-1316 Stock No.	SHUR-LOC [®] Swivel Hook S-1326 Stock No.
(in.)	(mm)												
1/4 (9/32)	7	273710	1011403X1	—	1014266	—	1049802	1015104	1098500	1017869	1029000	1022914	1004313
5/16	8	273729	1011412X2	—	1014266 1014280 1014285	—	1049809	1015113	1098504	1017878	1029009	1022914	1004313
3/8	10	273738	1011421X3	—	1014285 1014319	—	1049818	1015122	1098508	1017897	1029018	1002923	1004323
1/2	13	273747	1011430X4	—	1014319 1014331	—	1049827	1015136	1098512	1017906	1029027	1002932	1004331
5/8	16	273756	1011449X5	—	1014331 1014348	—	1049836	1015145	1098516	1017915	1029036	1002941	1004340
3/4	20	273858	1011458X6	—	1014348 1014365	—	—	1015154	—	—	1021071	1022942	1004349
7/8	22-23	273867	1011467X7	—	1014365 1014388	—	—	1015163	—	—	1029080	1022943	1004358
1	26	273876	—	—	1014388 1014404	—	—	1015172	—	—	1029089	1022944	—
1-1/4	32	—	—	—	1014404 1014422	—	—	1015181	—	—	—	—	—

DOUBLE LEG SLING

Spectrum 10 [®] Chain Size		Grade 100 Chain Stock No.	Master Link A-1342N + Stock No.	Master Link Assembly A-1345N + Stock No.	Master Link A-342 Stock No.	Master Link A-345 Stock No.	ELIMINATOR [®] L-1362 Stock No.	LOK-A-LOY [®] A-1337 Stock No.	Chain Coupler S-1325A Stock No.	Chain Shortener Link S-1311N Stock No.	SHUR-LOC [®] Clevis Hook S-1317 Stock No.	SHUR-LOC [®] Swivel Hook S-1316 Stock No.	SHUR-LOC [®] Swivel Hook S-1326 Stock No.
(in.)	(mm)												
1/4 (9/32)	7	273710	1011403X1	—	1014266	—	1049913	1015104	1098500	1017869	1029000	1022914	1004313
5/16	8	273729	1011412X2	—	1014285	—	1049922	1015113	1098504	1017878	1029009	1022914	1004313
3/8	10	273738	1011421X3	—	1014319	—	1049931	1015122	1098508	1017897	1029018	1002923	1004323
1/2	13	273747	1011430X4	—	1014331	—	1049940	1015136	1098512	1017906	1029027	1002932	1004331
5/8	16	273756	1011449X5	—	1014348	—	1049949	1015145	1098516	1017915	1029036	1002941	1004340
3/4	20	273858	1011458X6	—	1014365	—	—	1015154	—	—	1021071	1022942	1004349
7/8	22-23	273867	1011467X7	—	1014388	—	—	1015163	—	—	1029080	1022943	1004358
1	26	273876	—	—	1014404	—	—	1015172	—	—	1029089	1022944	—
1-1/4	32	—	—	—	1014468	—	—	1015181	—	—	—	—	—

TRIPLE AND QUAD LEG SLINGS

Spectrum 10 [®] Chain Size		Grade 100 Chain Stock No.	Master Link A-1342N + Stock No.	Master Link Assembly A-1345N + Stock No.	Master Link A-342 Stock No.	Master Link A-345 Stock No.	ELIMINATOR [®] Stock No.	LOK-A-LOY [®] A-1337 Stock No.	Chain Coupler S-1325A Stock No.	Chain Shortener Link S-1311N Stock No.	SHUR-LOC [®] Clevis Hook S-1317 Stock No.	SHUR-LOC [®] Swivel Hook S-1316 Stock No.	SHUR-LOC [®] Swivel Hook S-1326 Stock No.
(in.)	(mm)												
1/4 (9/32)	7	273710	—	1011510	—	1014739	See Page 219	1015104	1098500	1017869	1029000	1022914	1004313
5/16	8	273729	—	1011510	—	1014742		1015113	1098504	1017878	1029009	1022914	1004313
3/8	10	273738	—	1011529	—	1014766		1015122	1098508	1017897	1029018	1002923	1004323
1/2	13	273747	—	1011538	—	1014779		1015136	1098512	1017906	1029027	1002932	1004331
5/8	16	273756	—	1011547	—	1014807		1015145	1098516	1017915	1029036	1002941	1004340
3/4	20	273858	—	1011556	—	1014810		1015154	—	—	1021071	1022942	1004349
7/8	22-23	273867	—	1011565	—	1014845		1015163	—	—	1029080	1022943	1004358
1	26	273876	—	—	—	1014845		1015172	—	—	1029089	1022944	—
1-1/4	32	—	—	—	—	1014986		1015181	—	—	—	—	—



Grade 100 Assembly Chart

SINGLE LEG SLING

Spectrum 10® Chain Size										
(in.)	(mm)	SHUR-LOC® Swivel Hook w/ Bearing S-1326 Stock No.	Clevis Sling Hook L-1339 Stock No.	Eye Sling Hook L-1327 Stock No.	Cradle Grab Hook A-1338* Stock No.	Clevis Grab Hook A-1358* Stock No.	Eye Grab Hook A-1328 Stock No.	Clevis Foundry Hook A-1359 Stock No.	Eye Foundry Hook A-1329 Stock No.	Chain Choker A-1355 Stock No.
1/4 (9/32)	7	1004413	1049112	1025869	1049417	1049610	1026169	1049907	1026280	1015204
5/16	8	1004413	1049121	1025869	1049426	1049629	1026169	1049911	1026280	1015204
3/8	10	1004422	1049130	1025878	1049435	1049638	1026187	1049916	1026289	1015213
1/2	13	1004431	1049149	1025887	1049444	1049647	1026196	1049925	1026297	1015222
5/8	16	1004440	1049158	1025896	1049453	1049656	1026205	1049934	1026306	1015231
3/4	20	—	1049167	1025915	—	—	1026214	1049943	1026315	—
7/8	22-23	—	1049176	1025924	—	—	1026223	1049952	1026324	—
1	26	—	—	1025933	—	—	1016232	—	1026333	—
1-1/4	32	—	—	1025942	—	—	1026241	—	1026342	—

DOUBLE LEG SLING

Spectrum 10® Chain Size		SHUR-LOC® Swivel Hook w/ Bearing S-1326 Stock No.	Clevis Sling Hook L-1339 * Stock No.	Eye Sling Hook L-1327 Stock No.	Cradle Grab Hook A-1338* Stock No.	Clevis Grab Hook A-1358* Stock No.	Eye Grab Hook A-1328 Stock No.	Clevis Foundry Hook A-1359 Stock No.	Eye Foundry Hook A-1329 Stock No.	Chain Choker A-1355 Stock No.
(in.)	(mm)	SHUR-LOC® Swivel Hook w/ Bearing S-1326 Stock No.	Clevis Sling Hook L-1339 * Stock No.	Eye Sling Hook L-1327 Stock No.	Cradle Grab Hook A-1338* Stock No.	Clevis Grab Hook A-1358* Stock No.	Eye Grab Hook A-1328 Stock No.	Clevis Foundry Hook A-1359 Stock No.	Eye Foundry Hook A-1329 Stock No.	Chain Choker A-1355 Stock No.
1/4 (9/32)	7	1004413	1049112	1025869	1049417	1049610	1026169	1049907	1026280	1015204
5/16	8	1004413	1049121	1025869	1049426	1049629	1026169	1049911	1026280	1015204
3/8	10	1004422	1049130	1025878	1049435	1049638	1026187	1049916	1026289	1015213
1/2	13	1004431	1049149	1025887	1049444	1049647	1026196	1049925	1026297	1015222
5/8	16	1004440	1049158	1025896	1049453	1049656	1026205	1049934	1026306	1015231
3/4	20	—	1049167	1025915	—	—	1026214	1049943	1026315	—
7/8	22-23	—	1049176	1025924	—	—	1026223	1049952	1026324	—
1	26	—	—	1025933	—	—	1026232	—	1026333	—
1-1/4	32	—	—	1025942	—	—	1026241	—	1026342	—

TRIPLE AND QUAD LEG SLINGS

Spectrum 10® Chain Size		SHUR-LOC® Swivel Hook w/ Bearing S-1326 Stock No.	Clevis Sling Hook L-1339 Stock No.	Eye Sling Hook L-1327 Stock No.	Cradle Grab Hook A-1338* Stock No.	Clevis Grab Hook A-1358* Stock No.	Eye Grab Hook A-1328 Stock No.	Clevis Foundry Hook A-1359 Stock No.	Eye Foundry Hook A-1329 Stock No.	Chain Choker A-1355 Stock No.
(in.)	(mm)	SHUR-LOC® Swivel Hook w/ Bearing S-1326 Stock No.	Clevis Sling Hook L-1339 Stock No.	Eye Sling Hook L-1327 Stock No.	Cradle Grab Hook A-1338* Stock No.	Clevis Grab Hook A-1358* Stock No.	Eye Grab Hook A-1328 Stock No.	Clevis Foundry Hook A-1359 Stock No.	Eye Foundry Hook A-1329 Stock No.	Chain Choker A-1355 Stock No.
1/4 (9/32)	7	1004413	1048991	1025869	1049417	1049610	1026169	1049907	1026280	1015204
5/16	8	1004413	1049000	1025869	1049426	1049629	1026169	1049911	1026280	1015204
3/8	10	1004422	1049009	1025878	1049435	1049638	1026187	1049916	1026289	1015213
1/2	13	1004431	1049018	1025887	1049444	1049647	1026196	1049925	1026297	1015222
5/8	16	1004440	1049027	1025896	1049453	1049656	1026205	1049934	1026306	1015231
3/4	20	—	1049036	1025915	—	—	1026214	1049943	1026315	—
7/8	22-23	—	1049045	1025924	—	—	1026223	1049952	1026324	—
1	26	—	—	1025933	—	—	1026232	—	1026333	—
1-1/4	32	—	—	1025942	—	—	1026241	—	1026342	—

* Available with latch attached.



Grade 100 Chain Sling Components

WORKING LOAD LIMIT – 4 TO 1 DESIGN FACTOR

Chain Size		90°	60°	45°	30°	60°	45°	30°
(in.)	(mm)	Single Leg	Double Leg		Triple and Quad Leg			
—	6	3200	5500	4500	3200	8300	6800	4800
1/4 (9/32)	7	4300	7400	6100	4300	11200	9100	6400
5/16	8	5700	9900	8100	5700	14800	12100	8500
3/8	10	8800	15200	12400	8800	22900	18700	13200
1/2	13	15000	26000	21200	15000	39000	31800	22500
5/8	16	22600	39100	32000	22600	58700	47900	33900
3/4	20	35300	61100	49900	35300	91700	74900	52950
7/8	22	42700	74000	60400	42700	110900	90600	64000
1	26	59700	103400	84400	59700	155100	12600	89550
1-1/4	32	90400	156600	127800	90400	234900	191700	135600

*For choker applications, the Working Load Limit must be reduced by 20%. The Crosby A-1338 cradle grab hook and S1311N chain shortner link do not require any reduction of the Working Load Limit. The design factor of 4 to 1 on Spectrum® 10 Alloy Chain agrees with the design factor used by the International Standards Organization (I.S.O.) and ANSI B30.9 and is the preferred set of Working Load Limit values to be used.



Crosby ELIMINATOR® Fittings

Fatigue Rated



Crosby 8/10™



A-1361



The Crosby ELIMINATOR® combines selected features and functionality of a master link, connecting link, grab hook and adjuster legs to provide you with one fitting that is suitable for applications that require an adjustable length chain sling.

- Forged Alloy Steel - Quenched and Tempered.
- Innovative two piece design allows for maximum flexibility.
- Individually Proof Tested with certification.
- The Crosby ELIMINATOR®, if properly installed and locked, can be used for personnel lifting applications and meets the intent of OSHA Rule 1926.1431(g)(1)(i)(A) and 1926.1501(g)(4)(iv)(B).
- Suitable for use with Grade 100 and Grade 80 chain.
- Engineered to accommodate optional locking pins that can be inserted to "lock" the shortened chain legs into place.
- Fatigue rated at 1-1/2 times the Working Load Limit at 20,000 cycles.
- Use the A-1361 and A-1362 in combination to make 3 leg chain slings.
- Load pin assembly instructions on page 269.
- "Look for the Platinum Color - Crosby Grade 100 Alloy Products."
- All sizes are **RFID EQUIPPED**.

A-1362

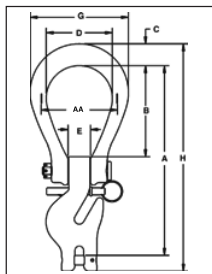

A-1361 Crosby ELIMINATOR® Single Hook

Chain Size		Frame Size	Working Load Limit (lbs.)*	A-1361 Stock No.	L-1361 Stock No.	Weight Each (lbs.)	Dimensions (in.)							
(in.)	(mm)						A	B	C	D	E	G	H	AA
1/4	7	2	4300	1049797	1049802	3.9	8.20	3.88	.90	3.00	.94	4.40	9.78	3.50
5/16	8	2	5700	1049804	1049809	3.9	8.18	3.88	.90	3.00	.94	4.40	9.78	3.50
3/8	10	3	8800	1049813	1049818	6.5	10.05	4.81	1.16	3.50	1.13	5.20	12.06	4.00
1/2	13	4	15000	1049822	1049827	13.5	12.88	6.00	1.63	4.13	1.31	6.39	15.57	5.00
5/8	16	5	22600	1049831	1049836	24.1	15.26	6.88	1.96	4.75	1.63	7.41	18.58	6.00

* Proof tested at 2.5 times the Working Load Limit. Minimum Ultimate Load is 4 times the Working Load Limit.

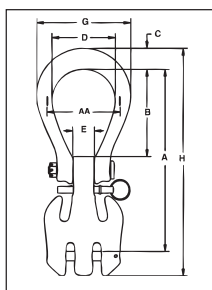

A-1362 Crosby ELIMINATOR® Double Hook

Chain Size		Frame Size	Working Load Limit (lbs.)*	A-1362 Stock No.	L-1362 Stock No.	Weight Each (lbs.)	Dimensions (in.)							
(in.)	(mm)						A	B	C	D	E	G	H	AA
1/4	7	2	8600	1049859	1049913	4.7	8.20	3.88	.90	3.00	.94	4.40	10.10	3.50
5/16	8	2	11400	1049868	1049922	4.7	8.18	3.88	.90	3.00	.94	4.40	10.10	3.50
3/8	10	3	17600	1049877	1049931	8.1	10.05	4.81	1.16	3.50	1.13	5.20	12.56	4.00
1/2	13	4	30000	1049886	1049940	17.3	12.88	6.00	1.63	4.13	1.31	6.39	16.25	5.00
5/8	16	5	45200	1049895	1049949	31.5	15.26	6.88	1.96	4.75	1.63	7.41	19.33	6.00

* Proof tested at 2 times the Working Load Limit. Minimum Ultimate Load is 4 times the Working Load Limit.

Using Crosby ELIMINATOR® in 3 and 4 Leg Slings

Spectrum 10 Chain Size		Master Link A-342 Stock No.	Master Link A-1342 Stock No.	Crosby ELIMINATOR® Single A-1361 Stock No.	Crosby ELIMINATOR® Double A-1362 Stock No.
(in.)	(mm)				
1/4 (9/32)	7	1014285	1011412	1049797	1049859
5/16	8	1014319	1011421	1049804	1049868
3/8	10	1014331	1011430	1049813	1049877
1/2	13	1014348	1011449	1049822	1049886
5/8	16	1014365	1011458	1049831	1049895

Use one of either A-342 or A-1342 master link.
Use one of each when making three leg sling.

Spectrum 10 Chain Size		Master Link A-342 Stock No.	Master Link A-1342 Stock No.	Crosby ELIMINATOR® Single A-1361 Stock No.	Crosby ELIMINATOR® Double A-1362 Stock No.
(in.)	(mm)				
1/4 (9/32)	7	1014285	1011412	-	1049859
5/16	8	1014319	1011421	-	1049868
3/8	10	1014331	1011430	-	1049877
1/2	13	1014348	1011449	-	1049886
5/8	16	1014365	1011458	-	1049895

Use one of either A-342 or A-1342 master link.
Use two A-1362 fittings when making quad leg sling.

Crosby ELIMINATOR® Fittings



Crosby ELIMINATOR® Components



A-1360B Bail

Chain Size		Frame Size	A-1360B Stock No.	Weight Each (lbs.)	Dimensions (in.)				S-4103 Replacement Hinge Pin Kit Stock No.
(in.)	(mm)				Inside Length	Inside Width	Jaw Width	Deformation Indicator	
1/4 - 5/16	7 - 8	2	1049626	2.1	3.88	3.00	.94	3.50	1092916
3/8	10	3	1049635	3.7	4.81	3.50	1.13	4.00	1092925
1/2	13	4	1049644	7.4	6.00	4.13	1.31	5.00	1092934
5/8	16	5	1049653	13.0	6.88	4.75	1.63	6.00	1092943



A-1360S Single Hook (shown with optional S-4104 Latch Pin)

Chain Size		Frame Size	Working Load Limit (lbs.)*	A-1360S Stock No.	L-1360S Stock No.	Weight Each (lbs.)	S-4100 Replacement Load Pin Kit Stock No.
(in.)	(mm)						
1/4	7	2	4300	1049671	1049790	1.8	1091801
5/16	8	2	5700	1049680	1049799	1.8	1091810
3/8	10	3	8800	1049699	1049808	2.8	1091829
1/2	13	4	15000	1049706	1049817	6.1	1091838
5/8	16	5	22600	1049715	1049826	11.1	1091847

* Ultimate Load is 4 times the Working Load Limit.



A-1360D Double Hook (shown with optional S-4104 Latch Pin)

Chain Size		Frame Size	Working Load Limit (lbs.)*	A-1360D Stock No.	L-1360D Stock No.	Weight Each (lbs.)	S-4102 Replacement Load Pin Kit Stock No.
(in.)	(mm)						
1/4	7	2	8600	1049733	1049838	2.6	1092713
5/16	8	2	11400	1049742	1049847	2.6	1092722
3/8	10	3	17600	1049751	1049856	4.4	1092731
1/2	13	4	30000	1049760	1049865	9.9	1092740
5/8	16	5	45200	1049779	1049874	18.5	1092759

* Ultimate Load is 4 times the Working Load Limit.

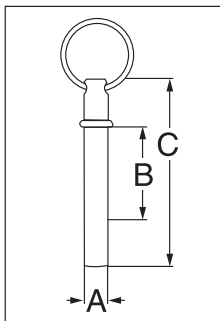

S-4104N Latch Pin

- The new style S-4104N latch pin is colored yellow zinc.
- The old style S-4104 latch pin is colored silver zinc.

Chain Size		Frame Size	S-4104N Stock No.	Weight Each (lbs.)	Dimensions (in.)		
(in.)	(mm)				A	B	C
1/4 - 5/16	7 - 8	2	1092983	.06	.313	1.36	2.58
3/8	10	3	1092992	.10	.313	1.62	3.08
1/2	13	4	1093001	.12	.313	1.83	3.83
5/8	16	5	1093010	.15	.313	2.21	4.59



Grade 100 Alloy Chain

**SPECTRUM 10[®]
ALLOY CHAIN**



- Alloy Steel.
- Heat Treated.
- 25% stronger than Grade 80 Alloy Chain.
- Permanently embossed with CG (Crosby Group) and 10 (Grade).
- Finish - Black rust preventative coating.
- Proof Tested at 2 times the Working Load Limit with certification.
- Standard container - fiber drum.

Grade 100 Alloy Chain Recommended for overhead lifting applications

Chain Size		Gr. 100 Drum Stock No.	Feet Per Drum	Material Size (in.)	Working Load Limit (lbs.)*	Maximum Inside Length (in.)	Maximum Inside Width (in.)	Maximum Length 100 Links (in.)	Weight Per 100 Feet (lbs.)
(in.)	(mm)								
9/32 (1/4)	7	273710	500	.276	4300	.87	.42	90	75
5/16	8	273729	500	.343	5700	1.01	.49	100	113
3/8	10	273738	500	.394	8800	1.23	.58	125	148
1/2	13	273747	300	.512	15000	1.57	.77	164	249
5/8	16	273756	200	.630	22600	1.93	.90	202	378
3/4	20	273858	100	.787	35300	2.52	.98	252	590
7/8	22	273867	100	.866	42700	2.77	1.08	277	740
1	26	273876	75	1.02	59700	3.28	1.28	328	1010

* Proof loaded at 2 times Working Load Limit. Ultimate Load is 4 times the Working Load Limit.

Fatigue Rated **Crosby 8/10™**

A-1337



- Suitable for use with both Grade 80 and Grade 100 chain.
- Individually Proof Tested at 2-1/2 times Working Load Limit with certification.
- Locking system that provides for simple assembly and disassembly - no special tools needed.
- 25% stronger than Grade 80.
- Meets ASTM A-952-96 standards for Grade 100 chain fittings.
- Forged Alloy Steel - Quenched and Tempered.
- Fatigue rated.

4

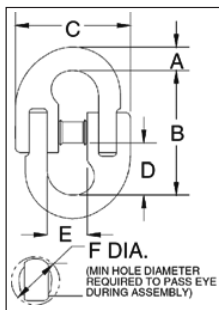

LOK-A-LOY[®] 10 Alloy Connecting Link

Chain Size		A-1337 Stock No.	Pkg. Qty.	Weight Each (lbs.)	Working Load Limit (lbs.)*	Dimensions (in.)					
(in.)	(mm)					A	B	C	D	E	F
9/32 (1/4)	7	1015104	60	.26	4300	.38	1.94	1.90	.81	.69	.57
5/16	8	1015113	50	.35	5700	.37	2.35	2.07	.99	.72	.64
3/8	10	1015122	40	.75	8800	.48	2.70	2.47	1.12	.90	.78
1/2	13	1015136	12	1.60	15000	.68	3.45	3.31	1.44	1.12	.97
5/8	16	1015145	10	2.68	22600	.81	4.13	3.90	1.72	1.35	1.14
3/4	20	1015154	1	5.00	35300	.93	4.62	4.62	2.03	1.62	1.28
7/8	22	1015163	1	7.50	42700	1.06	5.46	5.46	2.27	2.00	1.49
1	25	1015172	1	11.03	59700	1.22	5.98	6.13	2.44	2.25	1.76
1-1/4	32	1015181	1	20.38	90400	1.50	7.43	7.59	3.07	2.56	2.23

*Ultimate Load is 4 times the Working Load Limit.



Grade 100 Alloy Master Links



Crosby 8/10™

A-1342N



- Alloy Steel - Quenched and Tempered.
- Individually proof tested to values shown with certification.
- Proof tested with fixture sized to prevent localized point loading per ASTM A952.
- Proof test certification shipped with each link.
- All sizes are forged unless otherwise specified.
- “Look for the Platinum Color - Crosby Grade 100 Alloy Products.”
- Engineered Flat for use with S-1325A coupler link.

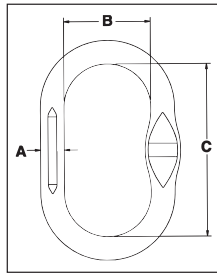

A-1342N Master Link

A-1342N Designation Marking	A-1342N Stock No.	Grade 100 Chain Size		Working Load Limit (lbs.)*	Proof Load (lbs.)	Weight Each (lbs.)	Dimensions (in.)		
		(in.)	(mm)				A	B	C
X 1	1011403	1/4	6 - 7	8600	17200	1.1	.60	2.50	5.00
X 2	1011412	5/16	8	11400	22800	1.7	.70	2.75	5.50
X 3	1011421	3/8	10	17600	35200	2.5	.81	3.00	6.00
X 4	1011430	1/2	13	30000	60000	6.2	1.09	4.00	8.00
X 5	1011449	5/8	16	45200	90400	10.6	1.34	5.00	9.00
X 6	1011458	3/4	19	70600	141200	18.8	1.63	5.25	10.50
X 7	1011467**	7/8	22	85400	170800	28.8	1.88	6.00	12.00

* Minimum Ultimate Load is 4 times the Working Load Limit.

** Welded.



Crosby 8/10™

A-1345N



- Alloy Steel - Quenched and Tempered.
- Individually proof tested to values shown with certification.
- Proof tested with fixture sized to prevent localized point loading per ASTM A952.
- Proof test certification shipped with each link.
- “Look for the Platinum Color - Crosby Grade 100 Alloy Products.”
- Engineered Flat for use with S-1325A coupler link.

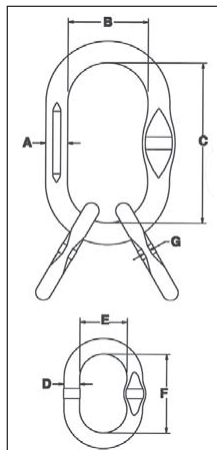

A-1345N Master Link Assembly

A-1345N Designation Marking	A-1345N Stock No.	Grade 100 Chain Size		Working Load Limit (lbs.)*	Proof Load (lbs.)	Weight Each (lbs.)	Dimensions (in.)						
		(in.)	(mm)				A	B	C	D	E	F	G
X 2	1011501	-	6	9600	19200	2.9	.70	2.75	5.50	.50	1.57	3.35	.24
X 3	1011510	1/4-5/16	7 - 8	17100	34200	4.2	.81	3.00	6.00	.56	1.77	3.35	.30
X 4	1011529	3/8	10	26400	52800	9.6	1.09	4.00	8.00	.75	2.36	3.94	.33
X 5	1011538	1/2	13	45000	90000	19.3	1.34	5.00	9.00	1.00	3.54	6.30	.51
X 6	1011547	5/8	16	67800	135600	31.4	1.65	5.25	10.50	1.25	3.94	7.09	.65
X 7	1011556	3/4	19	105900	211800	54.2	1.88	6.00	12.00	1.50	4.25	8.00	.81
X 8	1011565	7/8	22	128100	256200	112.2	2.25	8.00	16.00	1.88	6.00	12.00	.88

* Minimum Ultimate Load is 4 times the Working Load Limit.



Crosby® Grade 100 Eye Sling Hooks

Fatigue Rated **"QT"** QUIC-CHECK®

Crosby 8/10™

S-1327



- Forged Alloy Steel - Quenched and Tempered.
- Each hook has a Product Identification Code (PIC) for material traceability, along with the size and the name Crosby & U.S.A. in raised letters.
- 25% stronger than Grade 80.
- Eye Sling hooks incorporate two types of strategically placed markings forged into the product which address two (2) QUIC-CHECK® features: Deformation Indicators and Angle Indicators.
- Low profile hook tip.
- Utilizes S-4320 integrated latch which meets the world standard for lifting.
 - Heavy duty stamped latch interlocks with the hook tip.
 - High cycle, long life spring.
 - When secured with the proper cotter pin through the hole in the tip of hook, meets the intent of OSHA Rule 1926.1431(g) and 1926.1501(g) for personnel lifting.
- Individually Proof Tested to 2-1/2 times the Working Load Limit with certification.
- Suitable for use with Grade 100 and Grade 80 chain.
- Fatigue rated at 1-1/2 times the Working Load Limit at 20,000 cycles.
- "Look for the Platinum Color - Crosby Grade 100 Alloy Products."

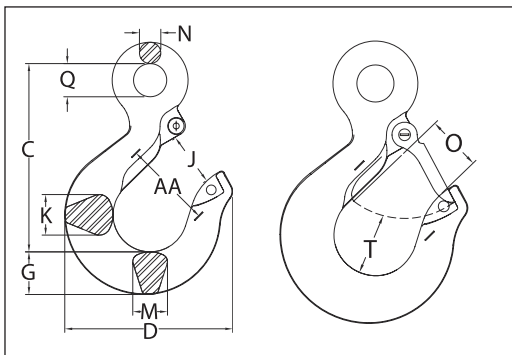

4

S-1327 Eye Sling Hook

Grade 100 Alloy Chain Size		Working Load Limit (lbs.)*	Hook ID Code	S-1327 Stock No.	L-1327 Stock No.	Weight Each (lbs.)	Dimensions (in.)											Replacement Latch Stock No.
(in.)	(mm)						C	D	G	J	K	M	N	O	Q	T	AA	
-	6	3200	DA	1025857	1025860	.50	3.34	2.86	.73	.90	.63	.63	.36	.89	.75	.87	1.50	1096325
1/4-5/16	7 - 8	5700	HA	1025866	1025869	1.3	4.21	3.90	1.03	1.18	.75	.75	.50	1.15	.75	1.16	2.00	1096468
3/8	10	8800	IA	1025875	1025878	2.3	4.99	4.34	1.19	1.53	1.19	1.00	.56	1.40	.94	1.23	2.50	1096515
1/2	13	15000	JA	1025884	1025887	4.5	6.36	5.67	1.44	1.78	1.37	1.17	.72	1.67	1.12	1.88	3.00	1096562
5/8	16	22600	KA	1025893	1025896	8.4	7.43	6.78	1.88	2.38	1.66	1.44	.88	2.21	1.31	2.03	4.00	1096609
3/4	18-20	35300	KA	1025911	1025915	15.0	9.07	7.45	2.25	2.29	1.88	1.63	1.11	2.08	2.44	2.47	4.00	1096609
7/8	22-23	44100	LA	1025920	1025924	20.7	10.08	8.30	2.59	2.50	2.19	1.94	1.27	2.27	2.84	2.62	4.00	1096657
1	26	59700	NA	1025929	1025933	39.5	12.82	10.30	3.00	3.30	2.69	2.38	1.56	3.02	3.50	2.83	5.00	1096704
1 1/4	32	90400	PA	1025938	1025942	105.0	18.19	14.06	4.56	4.25	3.75	3.19	2.00	3.00	4.50	3.88	7.00	1093717

* Ultimate Load is 4 times the Working Load Limit.



Crosby Grade 100 Clevis Sling Hooks

Fatigue Rated



Crosby 8/10™

A-1339



- Forged Alloy Steel - Quenched and Tempered.
- Individually Proof Tested to 2-1/2 times the Working Load Limit with certification.
- Each hook has a Product Identification Code (PIC) for material traceability, along with the size and the name Crosby & U.S.A. in raised letters.
- Hoist hooks incorporate two types of strategically placed markings forged into the product which address two (2) QUIC-CHECK® features: Deformation Indicators and Angle Indicators.
- Low profile hook tip.
- New integrated latch (S-4320/S-4339) meets the world standard for lifting.
 - Heavy duty stamped latch interlocks with the hook tip.
 - High cycle, long life spring.
 - When secured with the proper cotter pin through the hole in the tip of hook, meets the intent of OSHA Rule 1926.1431(g) and 1926.1501(g) for personnel lifting.
- Suitable for use with Grade 100 and Grade 80 chain.
- Fatigue rated at 1-1/2 times the Working Load Limit at 20,000 cycles.
- "Look for the Platinum Color - Crosby Grade 100 Alloy Products."

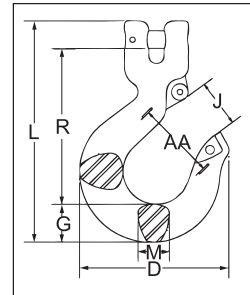

A-1339 Clevis Sling Hook

Chain Size		Working Load Limit (lbs.)*	Hook ID Code	A-1339 Stock No.	L-1339 Stock No.	Weight Each (lbs.)	Dimensions (in.)							S-4320 Repl. Latch Stock No.	S-4339 Repl. Latch Stock No.
(in.)	(mm)						D	G	J	L	M	R	AA		
-	6	3200	DA	1048982	1049103	0.64	2.86	0.73	0.93	4.21	0.63	2.95	1.50	1096325	-
1/4	7	4300	HA	1048991	1049112	1.58	3.86	1.04	1.19	5.67	0.75	3.97	2.00	1096468	-
5/16	8	5700	HA	1049000	1049121	1.57	3.86	1.04	1.19	5.67	0.75	3.95	2.00	1096468	-
3/8	10	8800	IA	1049009	1049130	2.58	4.38	1.19	1.53	6.75	1.00	4.71	2.50	1096515	-



Crosby® Grade 100 Foundry Hooks

Fatigue Rated



Crosby 8/10™

A-1359



- Forged Alloy Steel - Quenched and Tempered.
- Individually Proof Tested to 2-1/2 times the Working Load Limit with certification.
- Each hook has a Product Identification Code (PIC) for material traceability, along with the size and the name Crosby & U.S.A. in raised letters.
- Suitable for use with Grade 100 and Grade 80 chain.
- Fatigue rated at 1-1/2 times the Working Load Limit at 20,000 cycles.
- "Look for the Platinum Color - Crosby Grade 100 Alloy Products."
- Hook can be tip loaded at the reduced Working Load Limit, see below. Operator must ensure the load is retained properly in the hook.

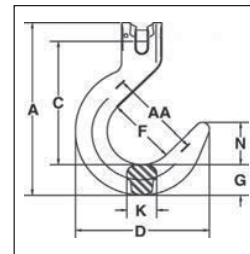

A-1359 Clevis Foundry Hook

Chain Size		A-1359 Stock No.	Working Load Limit at Saddle of Hook (lbs.)*	Working Load Limit at Tip of Hook (lbs.)*	Weight Each (lbs.)	Dimensions (in.)							
(in.)	(mm)					A	C	D	F	G	K	N	AA
1/4	7	1049907	4300	2150	2.15	6.26	4.38	4.82	2.50	1.13	0.88	1.57	3.50
5/16	8	1049911	5700	2850	2.06	6.26	4.37	4.82	2.50	1.13	0.88	1.57	3.50
3/8	10	1049916	8800	4400	4.29	7.76	5.54	5.82	3.00	1.38	1.30	1.88	4.00
1/2	13	1049925	15000	7500	7.97	9.38	6.67	7.04	3.50	1.63	1.50	2.25	4.50
5/8	16	1049934	22600	11300	14.2	11.25	7.68	8.17	4.00	2.19	1.75	2.53	5.00
3/4	18-20	1049943	35300	17650	24.7	14.43	9.79	9.65	5.00	2.40	2.20	3.39	6.00
7/8	22-23	1049952	44100	22050	43.8	16.25	11.02	11.03	5.50	3.07	2.72	3.74	6.50

* Ultimate Load is 4 times the Working Load Limit.

A-1329



- Forged Alloy Steel - Quenched and Tempered.
- Individually Proof Tested to 2-1/2 times the Working Load Limit with certification.
- Each hook has a Product Identification Code (PIC) for material traceability, along with the size and the name Crosby & U.S.A. in raised letters.
- Suitable for use with Grade 100 and Grade 80 chain.
- Fatigue rated at 1-1/2 times the Working Load Limit at 20,000 cycles.
- "Look for the Platinum Color - Crosby Grade 100 Alloy Products."
- Hook can be tip loaded at the reduced Working Load Limit, see below. Operator must ensure the load is retained properly in the hook.

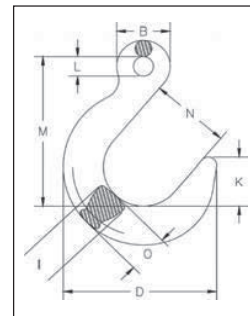

A-1329 Eye Foundry Hook

Chain Size		A-1329 Stock No.	Working Load Limit at Saddle of Hook (lbs.)*	Working Load Limit at Tip of Hook (lbs.)*	Weight Each (lbs.)	Dimensions (in.)							
(in.)	(mm)					B	D	I	K	L	M	N	O
1/4 - 5/16	7-8	1026280	5700	2850	2.00	1.56	4.82	.88	1.57	.63	4.81	2.50	1.13
3/8	10	1026289	8800	4400	3.80	2.07	5.82	1.30	1.88	.81	5.50	3.00	1.38
1/2	13	1026297	15000	7500	7.20	2.53	7.04	1.50	2.25	1.03	7.11	3.50	1.63
5/8	16	1026306	22600	11300	12.3	3.00	8.17	1.75	2.53	1.25	7.96	4.00	2.19
3/4	18-20	1026315	35300	17650	23.0	4.13	9.65	2.20	3.39	1.97	10.75	5.00	2.40
7/8	22-23	1026324	44100	22050	40.6	4.77	11.03	2.72	3.74	2.28	12.25	5.50	3.07
1	26	1026333	59700	29850	51.7	5.33	11.90	2.83	3.93	2.56	13.37	6.00	3.31
1 1/4	32	1026342	90400	45200	84.4	6.61	13.25	3.50	4.33	3.15	15.25	6.50	3.84

* Ultimate Load is 4 times the Working Load Limit.



Crosby® Grade 100 Clevis Grab Hooks

Fatigue Rated



Grosby 8/10™

A-1338

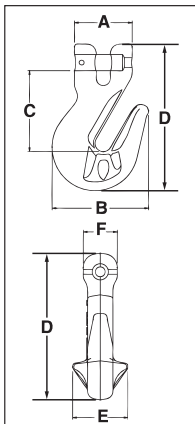

- Forged Alloy Steel - Quenched and Tempered.
- Innovative cradle design allows for 100% efficiency of Grade 100 chain.
- Individually Proof Tested to 2-1/2 times the Working Load Limit with certification.
- Each hook has a Product Identification Code (PIC) for material traceability, along with the size and the name Crosby & U.S.A. in raised letters.
- Suitable for use with Grade 100 and Grade 80 chain.
- The use of A-1338 Cradle Grab Hook will allow 100 percent of the chain sling capacity. When used to hook back to chain leg to form a choker, the angle of the choke must be 120 degrees or greater. When used as a chain shortener, minimize twist of chain and ensure chain is fully engaged in hook.
- Fatigue rated at 1-1/2 times the Working Load Limit at 20,000 cycles.
- "Look for the Platinum Color - Crosby Grade 100 Alloy Products."

L-1338

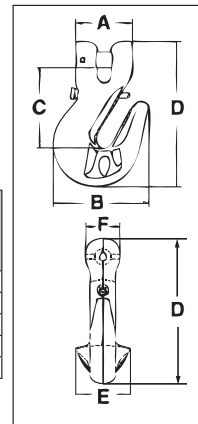

A/L-1338 Cradle Grab Hook

Chain Size (in.)	(mm)	Working Load Limit (lbs.)*	A-1338 Stock No.	L-1338 Stock No.	Weight Each (lbs.)	Dimensions (in.)						S-4338 Replacement Latch Kit Stock No.
						A	B	C	D	E	F	
1/4	7	4300	1049417	1049480	.45	1.72	2.54	2.20	3.88	1.50	.88	1048426
5/16	8	5700	1049426	1049489	.99	1.72	2.54	2.18	3.88	1.50	.88	1048426
3/8	10	8800	1049435	1049498	1.80	1.85	3.09	2.58	4.69	1.83	1.09	1048435
1/2	13	15000	1049444	1049507	3.92	2.39	3.83	3.28	5.88	2.25	1.42	1048444
5/8	16	22600	1049453	1049516	7.00	2.67	4.52	3.85	7.03	2.94	1.75	1048453

* Ultimate Load is 4 times the Working Load Limit.

Fatigue Rated



Grosby 8/10™

A-1358

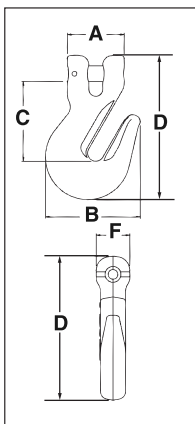

- Forged Alloy Steel - Quenched and Tempered.
- Individually Proof Tested to 2-1/2 times the Working Load Limit with certification.
- Each hook has a Product Identification Code (PIC) for material traceability, along with the size and the name Crosby & U.S.A. in raised letters.
- Suitable for use with Grade 100 and Grade 80 chain.
- Fatigue rated at 1-1/2 times the Working Load Limit at 20,000 cycles.
- "Look for the Platinum Color - Crosby Grade 100 Alloy Products."

L-1358

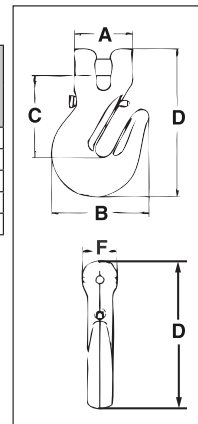

A/L-1358 Grab Hook

Chain Size (in.)	(mm)	Working Load Limit (lbs.)*	A-1358 Stock No.	L-1358 Stock No.	Weight Each (lbs.)	Dimensions (in.)					S-4338 Replacement Latch Kit Stock No.
						A	B	C	D	F	
1/4	7	4300	1049610	1049605	1.00	1.72	2.54	2.20	3.88	.88	1048426
5/16	8	5700	1049629	1049614	.99	1.72	2.54	2.18	3.88	.88	1048426
3/8	10	8800	1049638	1049623	1.80	1.85	3.09	2.58	4.69	1.09	1048435
1/2	13	15000	1049647	1049634	3.92	2.39	3.83	3.28	5.88	1.42	1048444
5/8	16	22600	1049656	1049643	7.00	2.67	4.52	3.85	7.03	1.75	1048453

* Ultimate Load is 4 times the Working Load Limit.



Crosby® Grade 100 Eye Grab Hooks

Fatigue Rated®



Crosby 8/10™

A-1328



- Forged Alloy Steel - Quenched and Tempered.
- Individually Proof Tested to 2-1/2 times the Working Load Limit with certification.
- Each hook has a Product Identification Code (PIC) for material traceability, along with the size and the name Crosby & U.S.A. in raised letters.
- Suitable for use with Grade 100 and Grade 80 chain.
- Fatigue rated at 1-1/2 times the Working Load Limit at 20,000 cycles.
- “Look for the Platinum Color – Crosby Grade 100 Alloy Products.”

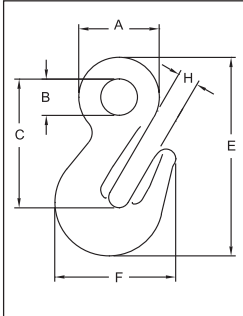

A-1328 Eye Grab Hook

Chain Size		Working Load Limit (lbs.)*	A-1328 Stock No.	Weight Each (lbs.)	Dimensions (in.)					
(in.)	(mm)				A	B	C	E	F	H
1/4 - 5/16	7 - 8	5700	1026169	0.98	1.75	.75	2.79	4.29	2.57	.44
3/8	10	8800	1026187	1.6	2.06	.94	3.33	5.13	3.09	.53
1/2	13	15,000	1026196	3.3	2.56	1.12	4.11	6.38	3.83	.66
5/8	16	22600	1026205	6	3.07	1.31	4.91	7.62	4.53	.79
3/4	18-20	35300	1026214	10.0	3.25	1.50	5.41	8.76	6.00	.94
7/8	22-23	44100	1026223	13.1	3.94	1.81	6.48	10.10	6.53	1.09
1	26	59700	1026232	18.9	4.44	2.00	7.22	11.45	7.75	1.19
1 1/4	32	90400	1026241	39.4	5.64	2.38	9.08	14.59	9.50	1.50

* Ultimate Load is 4 times the Working Load Limit.



Crosby® Grade 100 SHUR-LOC® Hooks

Fatigue Rated®



Crosby 8/10™

S-1316



- Forged Alloy Steel - Quenched and Tempered.
- 25% stronger than Grade 80.
- Individually Proof Tested to 2-1/2 times the Working Load Limit with certification.
- Recessed trigger design is flush with the hook body, protecting the trigger from potential damage.
 - Easy to operate with enlarged thumb access.
- Positive Lock Latch is Self-Locking when hook is loaded.
- Eye style is designed with "Engineered Flat" to connect to S-1325 chain coupler.
- Suitable for use with Grade 100 and Grade 80 chain.
- The SHUR-LOC® hook, if properly installed and locked, can be used for personnel lifting applications and meets the intent of OSHA Rule 1926.1431(g)(1)(i)(A) and 1926.1501(g)(4)(iv)(B).
- Fatigue rated at 1-1/2 times the Working Load Limit at 20,000 cycles.
- "Look for the Platinum Color - Crosby Grade 100 Alloy Products.

S-1317



SHUR-LOC® Hook Series with Positive Locking Latch

S-1316 Eye Hook

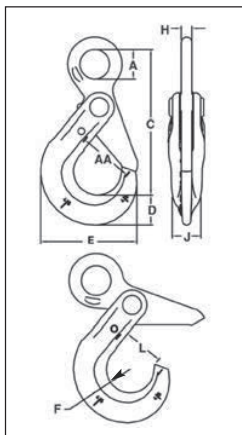

Chain Size		Working Load Limit (lbs.)*	S-1316 Stock No.	Weight Each (lbs.)	Dimensions (in.)									
(in.)	(mm)				A	C	D	E	F	H	J	L	AA	
-	6	3200	1022896	.85	.78	3.95	.79	2.60	.67	.31	.63	1.14	1.50	
1/4-5/16	7-8	5700	1022914	1.80	1.08	5.31	1.10	3.50	.87	.39	.81	1.48	2.00	
3/8	10	8800	1022923	3.40	1.30	6.57	1.17	4.39	1.10	.51	.94	1.83	2.50	
1/2	13	15000	1022932	6.00	1.65	8.23	1.67	5.45	1.26	.67	1.16	2.22	3.00	
5/8	16	22600	1022941	15.1	2.20	10.06	2.04	6.56	1.50	.87	1.50	2.65	3.50	
3/4	18-20	35300	1022942	19.0	2.60	10.77	2.22	7.76	2.01	.87	2.03	3.52	-	
7/8	22	42700	1022943	28.0	2.87	12.49	2.45	8.75	2.27	.98	2.20	3.83	-	
1	26	59700	1022944	49.5	3.15	14.60	3.21	9.87	2.46	1.26	2.68	4.09	-	

* Minimum Ultimate Load is 4 times the Working Load Limit.

S-1317 Clevis Hook

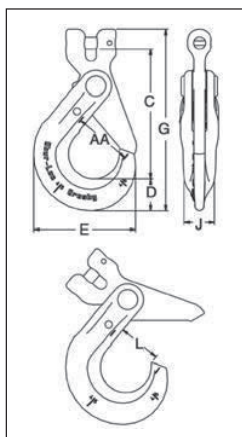

Chain Size		Working Load Limit (lbs.)*	S-1317 Stock No.	Weight Each (lbs.)	Dimensions (in.)						
(in.)	(mm)				C	D	E	G	J	L	AA
-	6	3200	1028991	.77	3.44	.79	2.60	4.75	.63	1.16	1.50
1/4	7	4300	1029000	1.80	4.48	1.10	3.51	6.25	.81	1.48	2.00
5/16	8	5700	1029009	1.80	4.47	1.10	3.51	6.25	.81	1.48	2.00
3/8	10	8800	1029018	3.66	5.53	1.17	4.39	7.54	.94	1.83	2.50
1/2	13	15000	1029027	6.80	6.81	1.67	5.49	9.52	1.16	2.22	3.00
5/8	16	22600	1029036	11.9	8.22	2.04	6.55	11.61	1.50	2.65	3.50
3/4	18-20	35300	1029071	15.0	9.42	2.22	7.76	13.21	2.03	3.52	-
7/8	22	42700	1029080	28.0	11.14	2.45	8.75	15.45	2.20	3.83	-
1	26	59700	1029089	49.5	12.56	3.21	9.87	18.44	2.68	4.09	-

* Minimum Ultimate Load is 4 times the Working Load Limit.



Crosby® Grade 100 SHUR-LOC® Hooks

Fatigue Rated **QT** QUIC-CHECK® Crosby 8/10™



S-1326

- Forged Alloy Steel - Quenched and Tempered.
- Individually Proof Tested at 2-1/2 times the Working Load Limit with certification.
- Recessed trigger design is flush with the hook body, protecting the trigger from potential damage.
 - Easy to operate with enlarged thumb access.
- Positive Lock Latch is Self-Locking when hook is loaded.
- G-414 Heavy Thimble should be used with wire rope slings.
- Trigger repair Kit available (S-4316). Consists of spring, roll pin and trigger.
- S-13326 Swivel Hook utilizes anti-friction bearing design which allows hook to rotate freely under load.
- Fatigue rated.
- The SHUR-LOC® hook, if properly installed and locked, can be used for personnel lifting applications and meets the intent of OSHA Rule 1926.1431(g)(1)(i)(A) and 1926.1501(g)(4)(iv)(B).
- “Look for the Platinum Color – Crosby Grade 100 Alloy Products”.
- U.S. Patent 5,381,650 and foreign equivalents.



S-13326

Use in corrosive environment requires shank and nut inspection in accordance with ASME B30.10-1.10.4(b)(5)(c)2009.

4

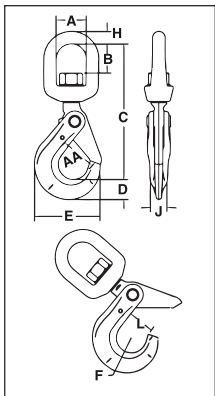

S-1326 SHUR-LOC® Swivel Hooks

- Suitable for infrequent, non-continuous rotation under load.

Chain Size		S-1326 Stock No.	Grade 100 Alloy Chain Working Load Limit (lbs.) 4:1*	Weight Each (lbs.)	Dimensions (in.)										
(in.)	(mm)				A	B	C	D	E	F	H	J	L	AA	
-	6	1004304	3200	1.26	1.50	1.32	6.13	.79	2.60	.67	.50	.63	1.13	1.50	
1/4-5/16	7-8	1004313	5700	2.62	1.75	1.59	7.60	1.10	3.50	.87	.63	.81	1.38	2.00	
3/8	10	1004322	8800	4.70	2.00	1.73	8.83	1.17	4.39	1.10	.75	.94	1.75	2.50	
1/2	13	1004331	15000	8.64	2.50	2.38	11.20	1.67	5.45	1.26	1.00	1.16	2.11	3.00	
5/8	16	1004340	22600	17.00	2.75	2.53	12.98	2.05	6.56	1.50	1.13	1.50	2.49	3.50	
3/4	18-20	1004349	35300	24.00	2.83	2.52	17.42	2.22	7.76	2.01	1.10	2.03	3.52	5.00	
7/8	22	1004358	42700	29.00	3.44	3.19	16.47	2.45	8.75	2.26	1.30	2.20	3.83	6.00	

* Ultimate Load is 4 times the Working Load Limit.

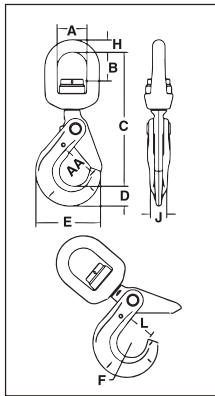

S-13326 SHUR-LOC® Swivel Hooks with Bearing

- Suitable for frequent rotation under load.

Chain Size		S-13326 Stock No.	Grade 100 Alloy Chain Working Load Limit (lbs.) 4:1*	Weight Each (lbs.)	Dimensions (in.)										
(in.)	(mm)				A	B	C	D	E	F	H	J	L	AA	
-	6	1004404	3200	1.50	1.50	1.14	6.17	.79	2.60	.67	.50	.63	1.13	1.50	
1/4-5/16	7-8	1004413	5700	3.10	1.75	1.52	7.54	1.10	3.50	.87	.63	.81	1.44	2.00	
3/8	10	1004422	8800	5.26	2.00	1.61	8.88	1.16	4.35	1.10	.75	.94	1.83	2.50	
1/2	13	1004431	15000	11.22	2.50	2.03	11.11	1.66	5.45	1.26	1.00	1.16	2.19	3.00	
5/8	16	1004440	22600	17.32	2.75	1.98	12.61	2.05	6.56	1.50	1.13	1.50	2.61	3.50	

* Ultimate Load is 4 times the Working Load Limit.



Crosby® Grade 100 Chain Fittings

Fatigue Rated®



Crosby 8/10™

S-1325A



- Designed to connect Grade 100 chain fittings produced with “Engineered Flat” to Grade 100 chain.
- Forged Alloy Steel - Quenched and Tempered.
- Suitable for use with Grade 100 and Grade 80 chain.
- Individually Proof Tested to 2-1/2 times the Working Load Limit with certification.
- Locking system that provides for simple assembly and disassembly – no special tools required.
- Fatigue rated at 1-1/2 times the Working Load Limit at 20,000 cycles.
- “Look for the Platinum Color – Crosby Grade 100 Alloy Products.”

S-1325A Grade 100 Chain Coupler

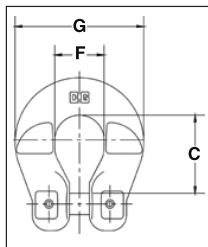

Chain Size		S-1325A Stock No.	Working Load Limit (lbs.)*	Weight Each (lbs.)	Dimensions (in.)		
(in.)	(mm)				C	F	G
-	6	1098496	3200	.25	1.03	.74	1.74
1/4	7	1098500	4300	.50	1.41	.88	2.32
5/16	8	1098504	5700	.50	1.40	.88	2.32
3/8	10	1098508	8800	.80	1.84	1.18	2.72
1/2	13	1098512	15000	1.70	2.12	1.50	3.62
5/8	16	1098516	22600	1.90	2.84	1.96	4.40

* Minimum Ultimate Load is 4 times the Working Load Limit.

Fatigue Rated®



Crosby 8/10™

S-1311N



- Alloy Steel - Quenched and Tempered.
- Individually Proof Tested to 2-1/2 times the Working Load Limit with certification.
- Suitable for use with Grade 100 and Grade 80 chain.
- Spring loaded chain locking system keeps chain in place under slack conditions.
- The use of S-1311N Chain Shortener will allow 100 percent of the chain sling capacity.
- Fatigue rated at 1-1/2 times the Working Load Limit at 20,000 cycles.
- “Look for the Platinum Color - Crosby Grade 100 Alloy Products.”

S-1311N Grade 100 Chain Shortener Link

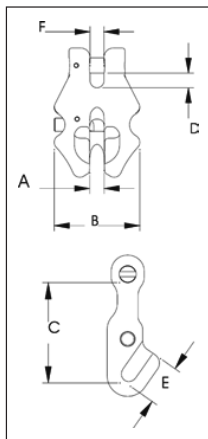

Chain Size		S-1311N Stock No.	Working Load Limit (lbs.)*	Weight Each (lbs.)	Dimensions (in.)					
(in.)	(mm)				A	B	C	D	E	F
-	6	1017860	3200	.49	.30	1.76	1.83	.29	.76	.29
1/4	7	1017869	4300	.84	.34	2.04	2.17	.34	.88	.33
5/16	8	1017878	5700	1.22	.40	2.36	2.53	.39	1.01	.38
3/8	10	1017897	8800	2.03	.48	2.84	3.07	.48	1.23	.46
1/2	13	1017906	15000	4.31	.62	3.56	3.77	.61	1.57	.59
5/8	16	1017915	22600	7.20	.73	4.24	4.64	.73	1.91	.70

* Minimum Ultimate Load is 4 times the Working Load Limit.

Crosby® Connecting Links



G-334 / S-334



- Forged Steel - Quenched and Tempered.
- Has larger inside dimensions making it easier to attach hooks or other fittings to the chain.
- An exclusive Crosby product.
- After making connections, rivets must be peened.

Pear Shape "Missing Link"® Replacement Links

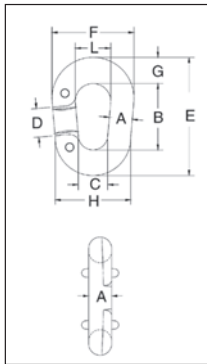

Chain Size (in.)	Stock No.		Working Load Limit (lbs.)*	Weight Per 100 (lbs.)	Dimensions (in.)								
	G-334 Galv.	S-334 S.C.			A	B	C	D	E	F	G	H	L
3/8	1013432	1013441	1850	25.00	.41	2.00	.56	.81	2.94	1.63	.47	1.38	.81
1/2	1013450	1013469	3300	50.00	.50	2.50	.69	1.00	3.63	2.00	.56	1.69	1.00
5/8	1013478	1013487	5000	75.00	.63	2.75	.81	1.06	4.00	2.38	.63	2.06	1.13
3/4	1013496	1013502	7100	125.00	.75	3.13	1.00	1.13	4.75	2.75	.81	2.50	1.25
7/8	1013511	1013520	9600	200.00	.88	3.69	1.25	1.38	5.56	3.25	.94	3.00	1.50

* Ultimate Load is 4 times the Working Load Limit.

Not Suitable for use with Grade 80 or Grade 100 chain and chain slings used in overhead lifting.



G-335 / S-335



- Forged Steel - Quenched and Tempered.
- Integral rivets join the two halves.
- After making connections, rivets must be peened.

4

Meets or exceeds the performance requirements of Federal Specifications RRC-271D, Type II, except for those provisions required of the contractor.

"Missing Link"® Replacement Links

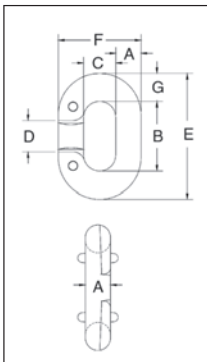

Chain Size (in.)	Stock No.		Working Load Limit (lbs.)*	Links Per Box	Weight Per 100 (lbs.)	Dimensions (in.)						
	G-335 Galv.	S-335 S.C.				A	B	C	D	E	F	G
**3/16	1013094	1013101	800	20	2.50	.25	.69	.34	.34	1.19	.78	.28
**1/4	1013110	1013129	1325	10	6.25	.28	.88	.44	.44	1.50	1.00	.31
**5/16	1013138	1013147	1950	10	12.50	.34	.94	.47	.47	1.69	1.16	.38
3/8	1013156	1013165	2750	10	20.00	.41	1.13	.56	.56	2.06	1.38	.47
7/16	1013174	1013183	3625	10	27.50	.47	1.28	.59	.59	2.34	1.53	.53
1/2	1013192	1013209	4750	10	37.50	.53	1.47	.66	.66	2.66	1.72	.59
5/8	1013236	1013245	7250	10	72.50	.66	1.81	.78	.81	3.31	2.09	.75
3/4	1013254	1013263	10250	10	122.50	.78	2.13	.94	1.06	3.88	2.50	.88
7/8	1013272	1013281	12000	Bulk	175.00	.91	2.50	1.13	1.13	4.50	2.94	1.00
† 1	1013290	1013307	15500	Bulk	250.00	1.03	2.75	1.25	1.25	5.00	3.31	1.13

* Ultimate Load is 4 times the Working Load Limit.

** Rivets Only - No interlocking lugs.

† Has reinforced rivet holes. All sizes have countersunk rivet holes.

Not Suitable for use with Grade 80 or Grade 100 chain and chain slings used in overhead lifting.



Crosby® Connecting Links



S-247



- All pins Alloy Steel - Quenched and Tempered.
- Body is forged and heat treated carbon steel.
- Designed for linking all popular sizes of Crosby Spectrum 3® and Spectrum 4® chain to rings, end links, eye hooks, pad eyes, tractor eye bolts, etc.
- Features quick and easy assembly.

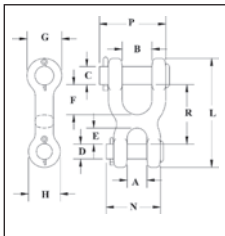

S-247 Double Clevis Link

Chain Size (in.)	S-247 Stock No.	Working Load Limit (lbs.)*	Weight Each (lbs.)	Dimensions (in.)											
				A	B	C	D	E	F	G	H	L	N	P	R
1/4	1013021	2600	.38	.50	.75	.50	.31	.38	.75	1.00	.81	2.81	1.38	1.66	1.50
5/16-3/8	1013049	5400	.81	.56	1.00	.63	.44	.47	1.00	1.19	1.00	3.53	1.75	2.25	1.91
7/16	1013067	7200	1.25	.69	1.13	.69	.56	.59	1.09	1.31	1.19	4.06	2.00	2.50	2.19
1/2	1013085	9200	1.56	.81	1.25	.75	.63	.68	1.25	1.44	1.31	4.53	2.25	2.75	2.47

* Ultimate Load is 4 times the Working Load Limit.

Not Suitable for use with Grade 80 or Grade 100 chain and chain slings used in overhead lifting.



S-249



- Available in three popular sizes.
- Body is forged and heat treated carbon steel.
- All pins Alloy Steel - Quenched and Tempered.
- Features quick and easy assembly.
- Twin Clevis design provides a variety of uses and can be used with Crosby Spectrum 3®, Spectrum 4® and Spectrum 7® chain.

4

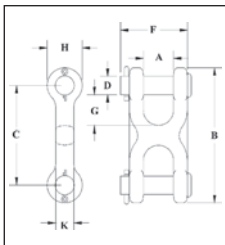

S-249 Twin Clevis Link

Chain Size (in.)	S-249 Stock No.	Working Load Limit (lbs.)*	Weight Each (lbs.)	Dimensions (in.)							
				A	B	C	D	F	G	H	K
1/4-5/16	1012861	4700	.31	.47	2.50	1.56	.38	1.31	.43	.94	.50
3/8	1012889	6600	.44	.53	2.81	1.81	.44	1.53	.50	1.00	.56
7/16-1/2	1012905	11300	.98	.65	3.62	2.31	.56	1.91	.63	1.31	.81

* Ultimate Load is 4 times the Working Load Limit.

Not Suitable for use with Grade 80 or Grade 100 chain and chain slings used in overhead lifting.



Chain Connecting Links

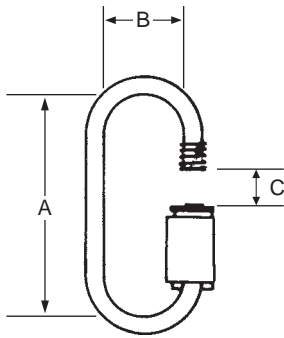

Quick Link or Rapid Link

Trade Size Inches	A Inside Length Inches	B Inside Width Inches	C Side Opening Inches	Working Load Limit Pounds*	Avg. Wt. Pounds Per 100
$\frac{3}{16}$	$1\frac{1}{2}$	$\frac{1}{2}$	$\frac{1}{4}$	750	4.50
$\frac{1}{4}$	$1\frac{3}{4}$	$\frac{9}{16}$	$\frac{9}{32}$	1,250	8.00
$\frac{5}{16}$	$2\frac{5}{16}$	$1\frac{1}{16}$	$\frac{3}{8}$	1,900	17.00
$\frac{3}{8}$	$2\frac{7}{16}$	$\frac{3}{4}$	$\frac{7}{16}$	2,650	23.00
$\frac{1}{2}$	$3\frac{3}{16}$	$1\frac{5}{16}$	$\frac{19}{32}$	4,500	51.00

*CAUTION: This working load limit should not be exceeded.
 APPLICATIONS: Used as a repair link, connecting link or attaching device on proof coil chain only.
 DESCRIPTION: Zinc-plated NOT heat-treated.

Cold Shut

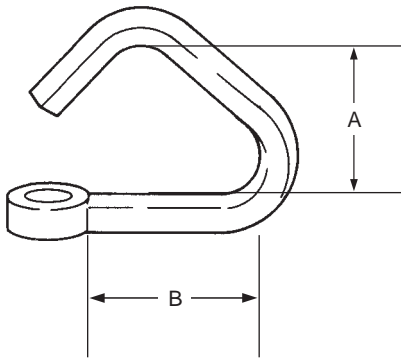

Trade Size Inches	A Inside Length Inches	B Inside Width Inches	Working Load Limit* Pounds	Avg. Wt. Pounds Per 100
$\frac{3}{16}$	$1\frac{1}{16}$	$\frac{5}{16}$	525	3
$\frac{1}{4}$	$1\frac{3}{16}$	$\frac{3}{8}$	925	6
$\frac{5}{16}$	$1\frac{7}{16}$	$\frac{13}{32}$	1,450	10
$\frac{3}{8}$	$1\frac{1}{4}$	$\frac{5}{8}$	2,110	18
$\frac{7}{16}$	$1\frac{3}{8}$	$\frac{13}{16}$	2,850	26
$\frac{1}{2}$	$1\frac{9}{16}$	$\frac{13}{16}$	3,750	38
$\frac{5}{8}$	$2\frac{1}{4}$	$\frac{3}{4}$	5,850	78
$\frac{3}{4}$	$2\frac{1}{2}$	$\frac{7}{8}$	8,425	130
$\frac{7}{8}$	$3\frac{3}{8}$	1	11,475	200
1	$3\frac{7}{8}$	$1\frac{3}{16}$	15,000	325

*CAUTION: This working load limit should not be exceeded.
 APPLICATIONS: As temporary repair link, use **one size larger** than the proof coil chain with which it is to be used. Also used to couple light attachments.
 DESCRIPTION: Low carbon steel, self-colored or zinc-plated finish.



Crosby® Grab Hooks



H-330 / A-330



- Forged Steel - Quenched and Tempered.
- Design factor is 4:1.
- Features quick and easy assembly.
- H-330 designed for Crosby Spectrum 4® chain.
- A-330 designed for Crosby Spectrum 7® chain.

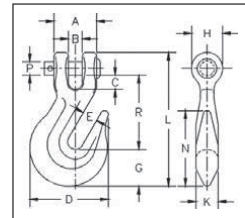

H-330 / A-330 Clevis Grab Hooks

Chain Size (in.)	Stock No.		Working Load Limit (lbs.)		Weight Each (lbs.)	Dimensions (in.)											
	H-330 Carbon	A-330 Alloy*	H-330 Carbon	A-330 Alloy		A	B	C	D	E	G	H	K	L	N	P	R
1/4	1027105	1027249*	2600	3500	.36	1.00	.32	.31	1.81	.34	.88	.72	.47	3.05	1.75	.31	1.64
5/16	1027123	1027267*	3900	4700	.62	1.22	.43	.36	2.12	.44	.97	.91	.59	3.66	2.06	.38	2.02
3/8	1027141	1027285*	5400	7100	1.00	1.42	.48	.49	2.53	.50	1.17	1.00	.72	4.42	2.34	.44	2.41
7/16	1027169	1027301	7200	8750	1.31	1.66	.66	.62	3.09	.56	1.31	1.13	.69	4.94	2.66	.56	2.75
1/2	1027187	1027329*	9200	12000	2.22	1.88	.57	.51	3.56	.66	1.53	1.25	.78	5.72	2.97	.63	3.19
5/8	1027203	1027347	13000	18100	4.41	2.31	.71	.67	4.39	.78	1.78	1.56	1.09	6.83	4.31	.75	4.09
3/4	1027221	1027365	20200	24700	6.50	2.62	.94	.94	5.22	.94	2.13	1.88	1.31	8.13	5.09	.88	4.63

* These A-330 hooks are forged with an "8" designating Grade 80, and are suitable for use with Grade 8 chain in over head lifting applications as long as hook is proof-tested as part of the chain sling assembly or as an individual component per ASME B30.9. We recommend the use of the A-338 which is proof tested and supplied with a proof test certificate.

H-323 / A-323



- Forged Steel - Quenched and Tempered.
- Design Factor is 4:1.
- H-323 designed for Crosby Spectrum 4® chain.
- A-323 designed for Crosby Spectrum 7® chain.

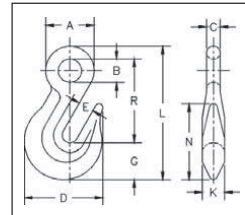

H-323 / A-323 Eye Grab Hooks

Chain Size (in.)	Stock No.		Working Load Limit (lbs.)		Weight Each (lbs.)	Dimensions (in.)											
	H-323 Carbon	A-323 Alloy*	H-323	A-323		A	B	C	D	E	G	K	L	N	R		
1/4	1026204	1026384*	2600	3500	.28	1.09	.53	.31	1.81	.34	.88	.47	3.05	1.75	1.88		
5/16	1026222	1026400*	3900	4700	.45	1.31	.62	.38	2.12	.44	.97	.59	3.59	2.06	2.28		
3/8	1026240	1026428*	5400	7100	.79	1.56	.75	.44	2.53	.50	1.17	.72	4.28	2.34	2.69		
1/2	1026286	1026464*	9200	12000	1.75	1.94	.88	.53	3.56	.66	1.53	.78	5.44	2.97	3.38		
5/8	1026302	1026482*	13000	18100	3.25	2.38	1.06	.66	4.41	.78	1.89	1.00	6.66	3.78	4.11		
3/4	1026320	1026507	20200	24700	5.94	2.88	1.38	.75	5.22	.94	2.13	1.31	8.06	5.09	5.16		

* These A-330 hooks are forged with an "8" designating Grade 80, and are suitable for use with Grade 8 chain in over head lifting applications as long as hook is proof-tested as part of the chain sling assembly or as an individual component per ASME B30.9. We recommend the use of the A-338 which is proof tested and supplied with a proof test certificate.

BL-GRB



Bullard Alloy Grab Hook with Latch

- Dimensions shown relate to H-323 / A-323 drawing scheme shown above.

Chain Size (in.)	BL-GRB Stock No.	Working Load Limit (lbs.)*	Weight Each (lbs.)	Dimensions (in.)											
				A	B	C	D	E	G	K	L	N	R		
1/4	1051904	3500	.50	1.25	.56	.28	2.47	.40	.86	.53	3.68	2.18	2.50		

* Ultimate Load is 4 times the Working Load Limit.



Crosby® Slip Hooks



H-331 / A-331



- Forged Carbon Steel or Forged Alloy Steel – Quenched and Tempered.
- All pins are Alloy Steel – Quenched and Tempered.
- **Not Suitable for use with Grade 80 chain and chain slings used in overhead lifting. For slings or lifting chains, Grade 80 or 100 alloy components are recommended.**

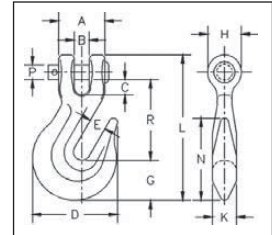

H-331 / A-331 Clevis Slip Hooks

Chain Size (in.)	Stock No.		Working Load Limit (lbs.)*		Weight Each (lbs.)	Dimensions (in.)													
	H-331 Carbon	A-331 Alloy	H-331 Carbon	A-331 Alloy		A	B	C	D	E	F	G	H	K	L	N	P	R	T
1/4	1027383	1027524	1950	2750	.55	1.06	.32	.29	2.75	.94	1.19	.81	.88	.50	3.95	2.13	.31	2.58	.81
5/16	1027409	1027542	2875	4300	.79	1.22	.43	.34	3.06	1.06	1.25	.94	1.00	.56	4.52	2.25	.38	2.87	.97
3/8	1027427	1027560	4000	5250	1.21	1.38	.45	.44	3.63	1.31	1.50	1.13	1.19	.66	5.15	2.56	.44	3.25	1.06
7/16	1027445	1027588	5000	7000	2.06	1.73	.59	.60	4.34	1.56	1.81	1.38	1.44	.81	5.97	3.06	.56	3.70	1.19
1/2	1027463	1027604	6500	9000	2.75	1.88	.57	.53	4.81	1.69	1.94	1.56	1.63	.91	6.53	3.44	.63	4.00	1.31
5/8	1027481	1027622	9250	13500	4.75	2.31	.71	.71	5.63	2.00	2.38	1.81	1.94	1.09	7.89	4.00	.75	4.94	1.56
3/4	–	1027640	–	19250	11.28	3.19	1.18	1.29	7.38	2.50	3.00	2.38	2.50	1.44	10.02	5.06	1.00	6.09	2.09

* Ultimate Load is 4 times the Working Load Limit.



4

H-324



- Forged Carbon Steel – Quenched and Tempered.
- **Not Suitable for use with Grade 80 chain and chain slings used in overhead lifting. For slings or lifting chains, Grade 80 or 100 alloy components are recommended.**

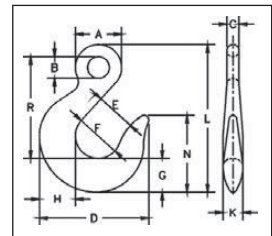

H-324 Eye Slip Hooks

Chain Size (in.)	H-324 Stock No.	Working Load Limit (lbs.)*	Weight Each (lbs.)	Dimensions (in.)											
				A	B	C	D	E	F	G	H	K	L	N	R
1/4	1026749	1950	.40	1.06	.50	.28	2.75	.94	1.19	.81	.88	.50	3.66	2.13	2.56
5/16	1026767	2875	.64	1.25	.63	.34	3.06	1.06	1.25	.94	1.00	.56	4.23	2.25	2.95
3/8	1026785	4000	1.10	1.53	.72	.41	3.63	1.31	1.50	1.13	1.19	.66	4.89	2.56	3.36
7/16	1026801	5000	1.56	1.69	.81	.44	4.34	1.56	1.81	1.38	1.44	.81	5.70	3.06	3.88
1/2	1026829	6500	2.09	1.94	.94	.50	4.81	1.69	1.94	1.56	1.63	.91	6.34	3.44	4.28
5/8	1026847	9250	3.90	2.38	1.13	.63	5.63	2.00	2.38	1.81	1.94	1.09	7.66	4.00	5.22
3/4	1026865	12500	6.93	2.88	1.38	.75	6.75	2.13	2.75	2.19	2.31	1.31	8.73	4.75	5.80

* Ultimate Load is 4 times the Working Load Limit.



Lebus® Load Binders



Load Rated

L-150



- Extra heavy construction at leverage point to prevent spreading. Heel of binder toggles away from load, permitting easy release.
- Ball and socket swivel joints at hook assemblies permit a straight line pull.
- Binders shown with Proof Loads have been individually proof tested to values shown, prior to shipment.

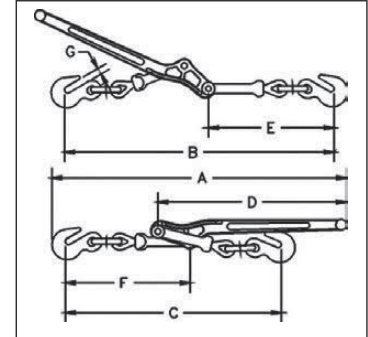

L-150 Standard Lever Type Load Binders

- Meets or exceeds requirements of US DOT FMCSA Part 393 Subpart I.

Model	Stock No.	Std. Pkg.	Min-Max Chain Size (in.)	Working Load Limit (lbs.)	Proof Load (lbs.)	Ultimate Load (lbs.)	Weight Each (lbs.)	Handle Length (in.)	Take Up (in.)	Dimensions (in.)						
										A	B	C	D	E	F	G
7-1	1048128	4	5/16-3/8	5400	10800	19000	7.02	16.00	4.50	24.13	22.13	17.88	16.00	10.38	10.38	.50
A-1	1048146	4	3/8-1/2	9200	18400	33000	12.47	18.69	4.50	28.75	25.75	21.25	18.69	12.31	12.38	.63
C-1	1048164	4	1/2-5/8	13000	26000	46000	19.68	21.00	4.75	31.25	29.75	25.00	21.00	14.63	13.75	.72

Lebus® Load Binders

Load Rated

L-140



- Upgraded for use with Grades 70, 80 and 100 Chain.
- Utilizes standard Crosby A-323 Alloy Eye Grab Hooks.
- New design “one piece” forged handle.
- Continuous take-up feature provides finite adjustment to tie down load.
- One piece assembly, no bolts or nuts to loosen.
- Ratchet spring is rust proofed.
- All load bearing or holding parts forged.
- Easy operating positive ratchet.
- Binders shown with Proof Loads have been individually proof tested to values shown, prior to shipment.

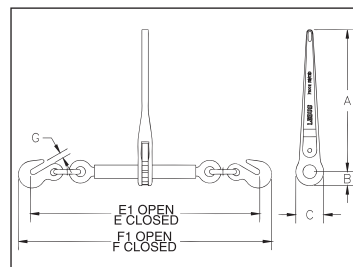

L-140 Standard Ratchet Type Load Binders

- Meets or exceeds requirements of US DOT FMCSA Part 393 Subpart I.

Model	Stock No.	Min-Max Chain Size (in.)	Working Load Limit (lbs.)*	Proof Load (lbs.)	Weight Each (lbs.)	Handle Length (in.)	Barrel Length (in.)	Take Up (in.)	Dimensions (in.)							
									A	B	C	E	E1	F	F1	G
R-7 **	1048404	5/16-3/8	8800	17600	12.11	14	10	8.0	14.00	1.38	2.75	22.94	30.94	25.13	33.13	.50
R-A **	1048422	3/8-1/2	15000	30000	14.70	14	10	8.0	14.00	1.38	2.75	25.25	33.25	27.63	35.63	.63
R-C ***	1048440	1/2-5/8	16000	32000	14.55	14	10	8.0	14.00	1.38	2.75	26.38	24.38	29.44	37.44	.72

* Ultimate Load is 3 times the Working Load Limit.

** Matches the Working Load Limit of Grade 100 chain for both sizes.

*** Matches the Working Load Limit of Grade 100 chain for 1/2" size.

R-7QL

4



- For use with Grade 7 Transport Chain.
- Utilizes standard Crosby A-323 Alloy Eye Grab Hooks.
- New design “one piece” forged handle.
- Continuous take-up feature, infinite adjustment, gets the last half of chain.
- One piece assembly, no bolts or nuts to loosen.
- Ratchet spring is rust proofed.
- All load bearings or holding parts forged.
- Easy operating positive ratchet.
- Binders shown with Proof Loads have been individually proof tested to values shown, prior to shipment.

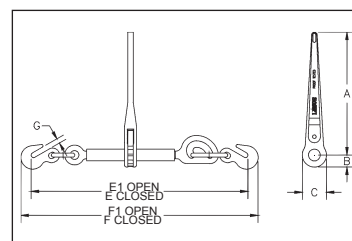

R-7QL QUIC-LINK Ratchet Load Binder

Model	R-7QL Stock No.	Min-Max Chain Size (in.)	Working Load Limit (lbs.)*	Proof Load (lbs.)	Weight Each (lbs.)	Handle Length (in.)	Barrel Length (in.)	Take Up (in.)	Dimensions (in.)							
									A	B	C	E	E1	F	F1	G
R-7QL	1048413	5/16-3/8	6600	13200	12.25	14	10	8.0	14.00	1.38	2.75	24.81	32.81	27.00	35.00	.50

* Ultimate Load is 3 times the Working Load Limit.



Lebus® Load Binders



A-1W

- Forged steel – Quenched and Tempered.
- Used as a come-a-long for short take-up on chain.
- Binder toggles away from the load.
- Binders shown with Proof Loads have been individually proof tested to values shown, prior to shipment.

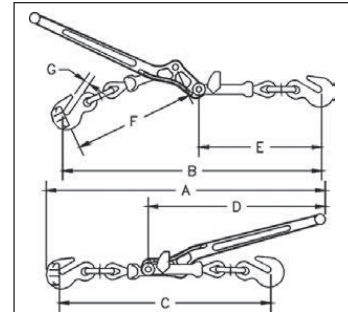

A-1W Walking Load Binders

- Meets or exceeds requirements of US DOT FMCSA Part 393 Subpart I.

Model	Stock No.	Chain Size (in.)	Working Load Limit (lbs.)	Proof Load (lbs.)	Ultimate Load (lbs.)	Weight Each (lbs.)	Handle Length (in.)	Dimensions (in.)						
								A	B	C	D	E	F	G
A-1W	1048388	1/2 only	9200	18400	33000	13.10	18.69	28.75	25.75	21.25	18.69	12.31	12.38	.63



R-10

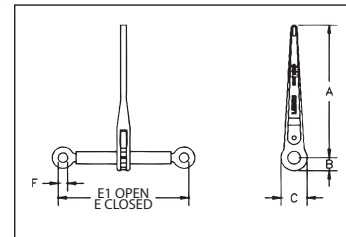

R-10 Binder without Links and Hooks

- Meets or exceeds requirements of US DOT FMCSA Part 393 Subpart I.

Model	R-10 Stock No.	Working Load Limit (lbs.)*	Weight Each (lbs.)	Handle Length (in.)	Barrel Length (in.)	Take Up (in.)	Dimensions (in.)					
							A	B	C	E	E1	F
R-10	1048468	16000	8.04	14	10	8.0	14	1.38	2.75	14	22	1.00

* Ultimate Load is 3 times the Working Load Limit.



Lebus® Load Binders



Load Rated

7-12 & A-12



- Forged steel – Quenched and Tempered.
- Spring cushion for load protection, cushions shock and sway.
- Binder toggles away from the load.

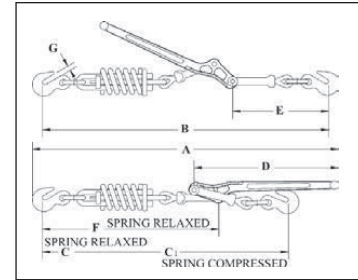

L-150 Snubbing Load Binders

Model	Stock No.	Min-Max Chain Size (in.)	Working Load Limit (lbs.)	Ultimate Load (lbs.)	Weight Each (lbs.)	Handle Length (in.)	Take Up (in.)	Compression Strength of Spring (lbs.)	Dimensions (in.)							
									A	B	C	C1	D	E	F	G
7-12	1048280	5/16 - 3/8	5400	16000	11.25	16.00	4.25	2300	32.75	30.75	28.00	26.50	16.00	10.38	19.00	.50
A-12	1048306	3/8 - 1/2	9200	20000	18.69	18.50	4.50	3300	37.19	34.00	29.50	30.44	18.69	12.31	20.88	.63

L-130

4



- Forged handle, hooks and swivel link.
- Steel swivels and clevis.

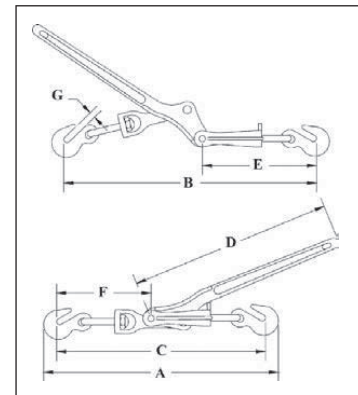

L-130 Midget Load Binders

- Meets or exceeds requirements of US DOT FMCSA Part 393 Subpart I.

Model	L-130 Stock No.	Min-Max Chain Size (in.)	Working Load Limit (lbs.)	Ultimate Load (lbs.)	Weight Each (lbs.)	Take Up (in.)	Dimensions (in.)						
							A	B	C	D	E	F	G
W-1	1048100	3/16-1/4	1450	5100	2.57	2.40	13.63	16.13	11.00	11.25	6.25	6.56	.34



Chain Sling Configuration

Alloy Grade 80

Adjustable Chain Slings (Traditional Styles)

Adjustable Loop Chain Slings

Chain Size (in.)	Rated Capacity* at 60° (lbs.)	
	Single	Double
7/32	3,600	5,450
9/32	6,100	9,100
3/8	12,300	18,400
1/2	20,800	31,200
5/8	31,300	47,000
3/4	49,000	73,500
7/8	59,200	88,900
1	82,600	123,900
1 1/4	125,200	187,800

Master Link Dimensions page 47
Hook Dimensions pages 87 & 88

Adjustable Chain Slings

Chain Size (in.)	Rated Capacity* (lbs.)	
	Single at 90°	Double at 60°
7/32	2,100	3,600
9/32	3,500	6,100
3/8	7,100	12,300
1/2	12,000	20,800
5/8	18,100	31,300
3/4	28,300	49,000
7/8	34,200	59,200
1	47,700	82,600
1 1/4	72,300	125,200

**Style B, single and double adjustable slings are furnished with approximately one (1) foot of chain in short branches unless otherwise specified in the order. Style A, hook is attached to master link with a coupling link.

NOTE 1: Also referred to as Working Load Limit.

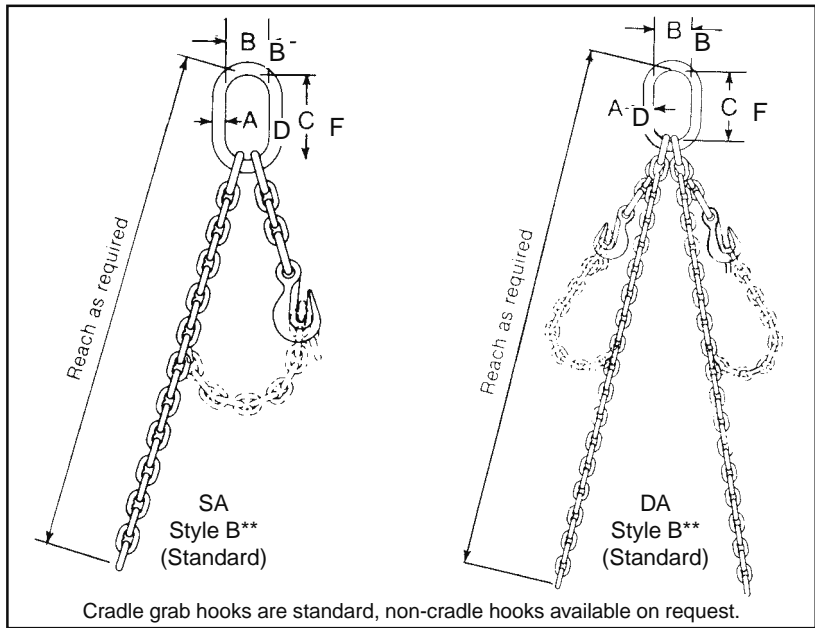

Lockable cradle grab hooks are available to 3/4".

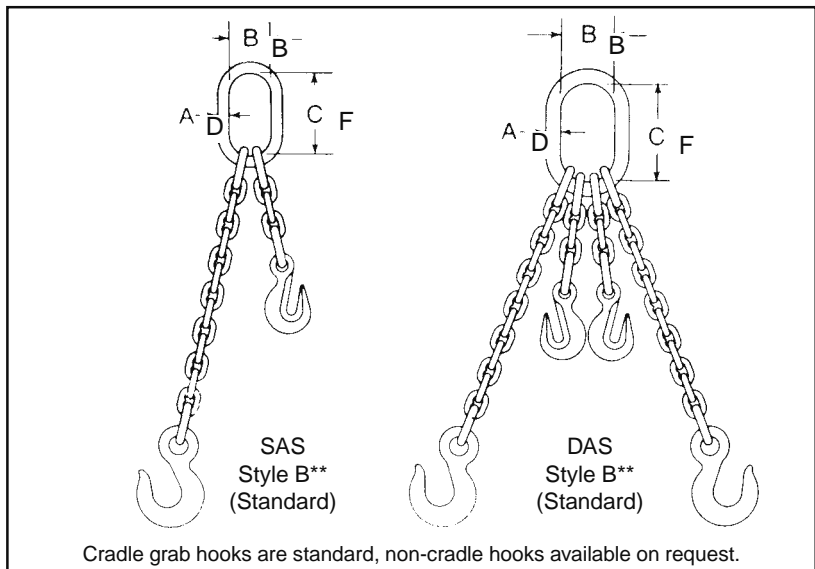

Lockable cradle grab hooks are available to 3/4".

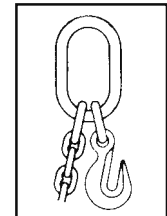

Style A



Chain Sling Configurations

Alloy Grade 80

Basket Type Chain Slings

Chain Size (in.)	Rated Capacity* at 60° (lbs.)	
	Single	Double
7/32	3,600	5,450
9/32	6,100	9,100
3/8	12,300	18,400
1/2	20,800	31,200
5/8	31,300	47,000
3/4	49,000	73,500
7/8	59,200	88,900
1	82,600	123,900
1 1/4	125,200	187,800

Note: 1. Also referred to as "Working Load Limit".

* Do not exceed rated capacities. Ratings must be reduced when used with slings at angles of less than 90° from horizontal.

Master Link Dimensions page 47

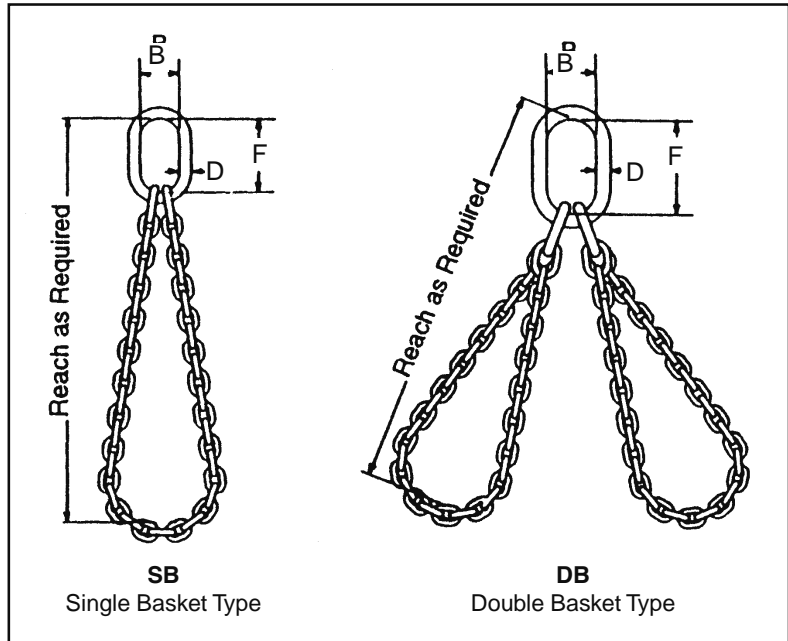

SB
Single Basket Type

DB
Double Basket Type

Endless Basket Chain Slings

4

Chain Size (in.)	Rated Capacity* (lbs.)	
	Single at 90°	Double at 60°
7/32	2,100	3,600
9/32	3,500	6,100
3/8	7,100	12,300
1/2	12,000	20,800
5/8	18,100	31,300
3/4	28,300	49,000
7/8	34,200	59,200

Note: 1. Also referred to as "Working Load Limit".

* Do not exceed rated capacities. Ratings must be reduced when used with slings at angles of less than 90° from horizontal.

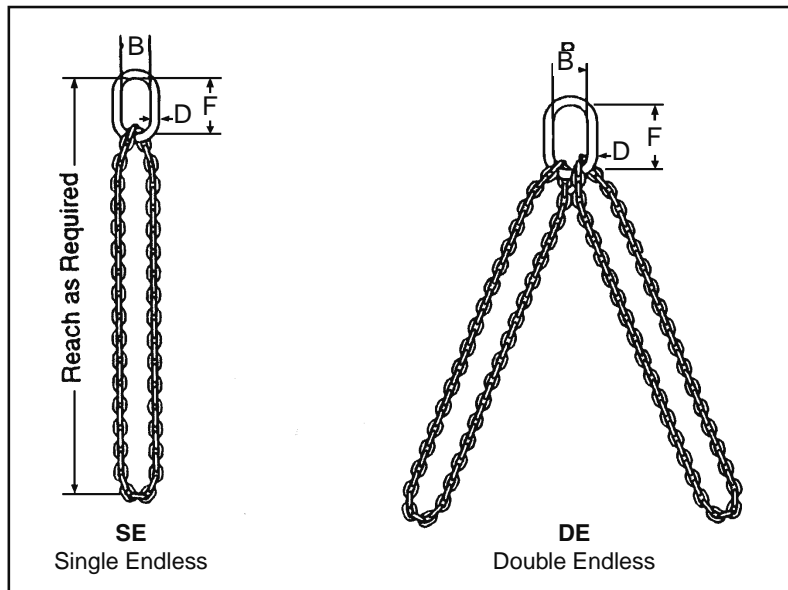

SE
Single Endless

DE
Double Endless



Welded Chain Specifications

TRANSPORT CHAIN (GRADE 70)

Significantly higher tensile strength for all load binding and tie down applications, which permits you to hold a given load with the next smaller size chain than High Test. This increased strength-to-weight ratio means lower costs and a lighter chain, for easier storage and handling.

Trade Size In Inches	Size Material in Inches	Working* Load Limit Lbs.	Nominal Inside Length in Inches	Nominal Inside Width in Inches	Maximum Length 100 Links in Inches	Weight per 100 Feet Lbs.
1/4	9/32	3,150	.76	.40	87	76
5/16	11/32	4,700	.98	.46	102	113
3/8	13/32	6,600	1.14	.54	119	162
7/16	15/32	8,700	1.29	.62	134	212
1/2	17/32	11,300	1.43	.72	149	270

*Working load limit must not be exceeded.
Not to be used for overhead lifting.
Boomer chains or binder chains available on request.

HIGH TEST CHAIN (GRADE 40 OR 43)

High test chain features both high tensile strength and resistance to wear needed by modern hauling and heavy duty trucking. Working load limit exceeds those of ordinary low carbon or general utility chain.

MATERIAL High carbon steel. Minimum tensile 85,000 psi. **FINISH** Self-colored, and hot galvanized.

Trade Size in Inches	Size Material in Inches	Working* Load Limit Lbs.	Nominal Inside Length in Inches	Nominal Inside Width in Inches	Maximum Length 100 Links in Inches	Weight Per 100 Feet Lbs.
1/4	9/32	2,600	.82	.39	86	75
5/16	11/32	4,000	1.01	.48	105	111
3/8	13/32	5,400	1.15	.56	121	157
7/16	15/32	7,200	1.29	.65	135	213
1/2	17/32	9,200	1.43	.75	150	274
5/8	21/32	11,500	1.79	.90	186	409
3/4	25/32	16,200	1.96	1.06	205	603
7/8	29/32	22,500	2.25	1.14	235	735
1	1 1/32	26,500	2.66	1.34	277	975

*Working load limit must not be exceeded.
Not to be used for overhead lifting.

HIGH TEST BOOMER CHAINS OR BINDER CHAINS

Made according to ASTM specifications. Bright Polished High Test Steel. Ridgeless electrically welded, with grab hook at each end.

Size x Length	Working Load Limit	Approx. Weight Each/Lbs.
1/4" x 20'	2,600	16
5/16" x 20'	4,000	22
3/8" x 20'	5,400	32
7/16" x 20'	7,200	44
1/2" x 20'	9,200	54
5/8" x 20'	11,500	86

*Working load limit must not be exceeded.
Not to be used for overhead lifting.

PROOF COIL CHAIN (GRADE 28 OR 30)

A general utility chain for such uses as log chain, cargo lashing chain, pipe line hanging chain, tailgate, guard rail, tow and switch chain.

MATERIAL Low carbon steel. Minimum tensile 55,000 psi. **FINISH** Self-colored, bright zinc and hot galvanized.

Trade Size In Inches	Size Material in Inches	Working* Load Limit Lbs.	Nominal Inside Length in Inches	Nominal Inside Width in Inches	Maximum Length 100 Links in Inches	Weight per 100 Fet Lbs.
3/16	7/32	750	.95	.40	99	40
1/4	9/32	1,250	1.00	.50	104	71
5/16	11/32	1,875	1.10	.50	114	107
3/8	13/32	2,625	1.23	.62	128	158
7/16	15/32	3,500	1.38	.75	142	213
1/2	17/32	4,500	1.50	.81	156	278
5/8	21/32	6,800	1.87	1.00	194	410
3/4	25/32	9,500	2.12	1.12	220	580
7/8	29/32	11,375	2.50	1.37	260	811
1	1 1/32	13,950	2.75	1.50	286	1045

*Working load limit must not be exceeded.
Not to be used for overhead lifting.

Synthetic Web Slings





Recommended Practices

For a complete review of recommended industry practices, please refer to:

- ASME B30.9 Sling Safety Standard
- OSHA Industrial Slings Regulations (Office of the Federal Register)
- Web Sling Tie Down Association Technical Manual

Do:

- Make sure load weight is within the sling's rated capacity; slings should be long enough so the rated load is adequate when the sling to load angle is considered.
- Select sling characteristics that are suitable for the load, hitch and environment
- Slings with fittings used in a choker hitch should be of sufficient length to ensure choking action is on the webbing, not the fitting
- Balance loads on basket hitch slings to prevent slippage
- Make sure fitting opening shape and size ensure proper seating in the hook and other attachments
- Protect slings from being cut by sharp edges or abrasive surfaces.
- Keep tags and labels away from the load, hook, and point of choke
- Place blocks under a load to allow removal of sling
- Hitch slings so that the load is controlled.
- Make sure personnel stand clear of suspended loads and remain alert for snagging
- Avoid shock loading
- Avoid twisting and kinking of legs (branches)
- Sling legs (branches) should support the load from the sides above the center of gravity when in a basket hitch
- Center load applied to the hook

Don't:

- Load slings in excess of rated capacity (consider load angle)
- Twist, shorten, lengthen, or tie knots in slings
- Drag slings on the floor or abrasive surfaces
- Pull slings out from under a load
- Drop slings equipped with metal fittings
- Constrict or bunch slings and labels between the ears of a clevis, shackle, or in a hook
- Use slings that appear to be damaged
- Allow personnel to ride the sling or load being lifted
- Use slings with illegible tags

Removal from Service

A flat web sling shall be removed from service if any of the following is visible:

- If sling rated capacity or sling material identification is missing or not readable.
- Acid or alkali burns.
- Melting, charring or weld spatter of any part of the web sling.
- Holes, tears, cuts snags or embedded particles.
- Broken or worn stitching in load bearing splices.
- Excessive abrasive wear.
- Knots in any part of the web sling.
- Distortion and excessive pitting, corrosion or broken fittings.
- Any conditions which cause doubt as to the strength of the sling.

Exposure To Common Chemicals

Chemical	Polyester	Nylon
Acid	†	No
Alcohol	OK	OK
Aldehydes	NO	OK
Strong Alkalis	**	OK
Bleaching Agents	OK	NO
Dry Cleaning Solvents	OK	OK
Ethers	NO	OK
Halogenated Hydrocarbons	OK	OK
Hydrocarbons	OK	OK
Ketones	OK	OK
Oil, Crude	OK	OK
Oil, Lubricating	OK	OK
Soaps, Detergents	OK	OK
Water, Seawater	OK	OK
Weak Alkalis	OK	OK

† Disintegrated by concentrated sulphuric acid.

** Degraded by strong alkalis at elevated temperatures

• Acid Damage



• Heat Damage



• Cuts

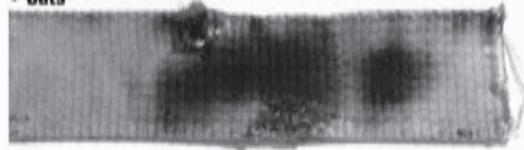

• Abrasion Damage



• Face Cuts

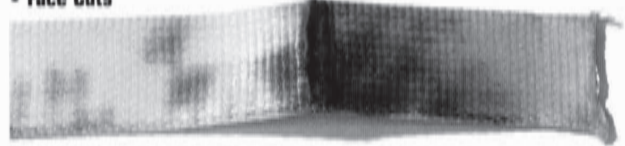

• Punctures & Snags

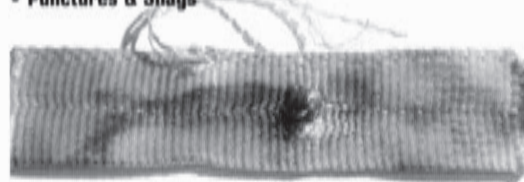

• Tensile Break

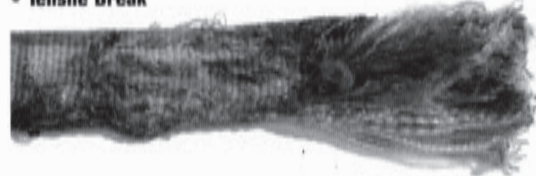

• Illegible or Missing Tag

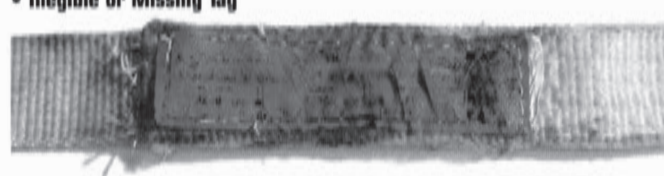



Rated Capacity Information

Angle Degrees	Factor
90	1.0000
85	0.9962
80	0.9848
75	0.9659
70	0.9397
65	0.9063
60	0.8660
55	0.8192
50	0.7660
45	0.7071
40	0.6528
35	0.5736
30	0.5000
25	0.4226
20	0.3420
15	0.2588

Rated Capacity

The rated capacities of the slings in this catalog are given in pounds. Refer to the maximum recommended weight for which the sling is to be used in one of the standard types of lifts as illustrated:

Effect of Angle

When slings are used at an angle (i.e.-two slings or one sling in a basket attached to only one crane hook), sling capacity is reduced. How much it is reduced depends on the degree of the angle. You can determine whether a sling will be rated high enough if you know the angle between the sling leg and the horizontal. Once you know this angle, multiply the sling's rating by the appropriate factor in the table. This will give you the sling's reduced rating.

Sling Capacity decreases as the angle increases.

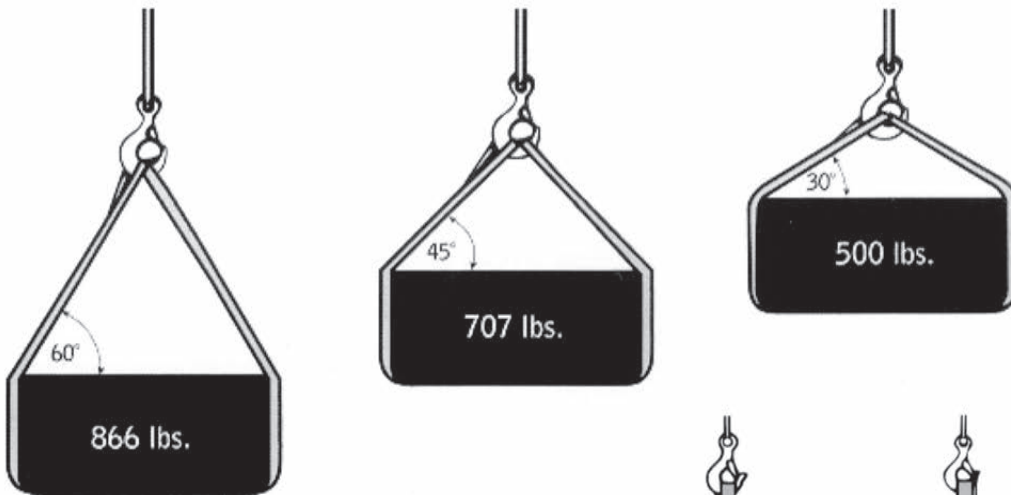

A sling capable of lifting 1,000 lbs. in a 90 vertical basket hitch, can only lift 866 lbs. at a 60° angle, 707 lbs. at a 45° angle, and 500 lbs. at a 30° angle.

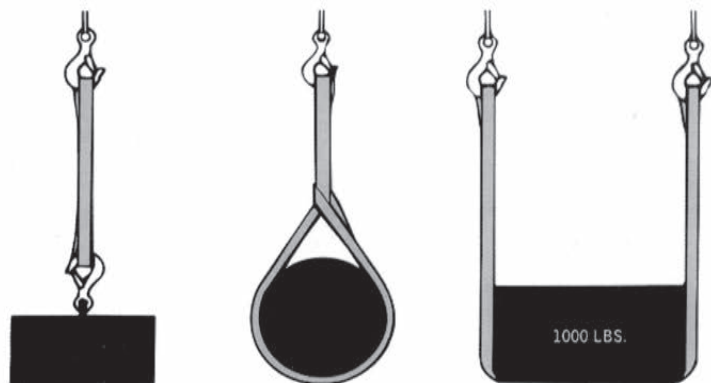

Vertical Hitch

Choker Hitch

Basket Hitch



Customize Your Sling

Flat Web Material Options

9800# Heavy Duty Nylon Webbing: Industry standard webbing, suited for most applications.

7000# Light Duty Nylon Webbing: An economical alternative for lighter applications.

9800# Polyester Webbing: For applications where the sling is exposed to acidic environments or strong alkalis.

9800# Scuff Edge™: These polyester web slings have polymer coated yarns woven into the edges to reduce damage and increase life.

Cordura Jacketed: Has Cordura fibers woven into the outer layer of the web material, providing increased strength and wear protection.

Custom Printed Tags

IRSCI can custom print tags in Tyvek, vinyl and leather. Each type has unique qualities, depending upon customer preference. (Private label programs available)

Tyvek:

INDUSTRIAL WIRE ROPE SUPPLY Co. Inc.
EE4 902 LENGTH 10 FT. NYLON
VERTICAL 10000
CHOKER 8000 DO NOT EXCEED
BASKET 20000 RATED CAPACITIES IN LBS.

These durable tags are printed on demand by IRSCI. Tyvek tags offer customers greater flexibility and can be serialized, customized with company logos, and bar coded; there is no minimum quantity or premium charge for Tyvek tags.

Vinyl:

INDUSTRIAL WIRE ROPE SUPPLY POLY-133X
MAXIMUM LOAD CAPACITIES FOR NEW SLINGS *WARNING* DO NOT EXCEED
VERTICAL 6,000 LBS. CHOKER 5,000 LBS. BASKET 12,000 LBS.
WIDTH 2" LENGTH 6 FT. DATE 3-25-18 TYPE EE72-002 S/N 0130145-17

A very durable tag, printed with diagrams accompanying the rated lifting capacities of the slings. The vinyl tag must be pre-printed and carries a small premium charge (price varies by quantity). IRSCI will stock and maintain customers vinyl tag inventory.

Leather:

INDUSTRIAL EE2702
VERTICAL 4000 20FT
CHOKER 3000 NYLON
BASKET 3000 LBS

Leather is the most durable of the three tags. Leather tags can be branded with serial numbers and other identifying information, such as your company's logo, at the distributor or end user level. It carries a premium charge, but can be purchased in any quantity.

Wear Protection

Wear protection prolongs life of the sling, ultimately resulting in cost effectiveness. IRSCI utilizes four wear materials: Pukka (a 5/16" felt pad, as shown), leather, Cordura and nylon, which can be used in any of the following configurations:

- Eye or Body Wrapped
- Edge guard treatment, protects against edge abrasion
- Lined eye, protects the sling at lifting point
- Velcro sliding pad, easily removable
- Sewn-on, attached to sling
- Sliding sleeve, adjustable

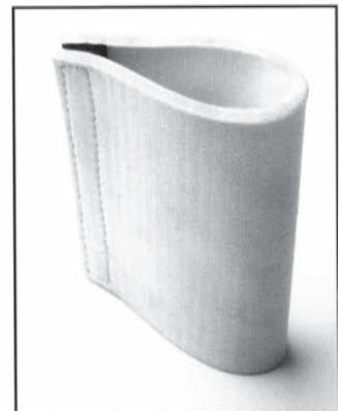



Nylon and Polyester Web Slings



type 1
triangle choker

type 2
triangle triangle

HEAVY DUTY

TYPE 1 (TC)	TYPE 2* (TT)	RATED CAPACITIES IN LBS.		
		VERTICAL	CHOKER	BASKET
ONE PLY				
TC1-902	TT1-902	3,200	2,500	6,400
TC1-903	TT1-903	4,800	3,800	9,600
TC1-904	TT1-904	6,400	5,000	12,800
TC1-906	TT1-906	9,600	7,700	19,200
TC1-908	TT1-908	12,800	10,200	25,600
TC1-910	TT1-910	16,000	12,800	32,000
TC1-912	TT1-912	19,200	15,400	38,400
TWO PLY				
TC2-902	TT2-902	6,400	5,000	12,800
TC2-903	TT2-903	8,600	6,900	17,200
TC2-904	TT2-904	11,500	9,200	23,000
TC2-906	TT2-906	16,300	13,000	32,600
TC2-908	TT2-908	19,200	15,000	38,400
TC2-910	TT2-910	22,400	17,400	44,800
TC2-912	TT2-912	26,900	21,500	53,800

Three and four ply hardware slings are available upon request.
 * Type 2 can not be used in a choker hitch.

LIGHT DUTY

TYPE 1 (TC)	TYPE 2* (TT)	RATED CAPACITIES IN LBS.		
		VERTICAL	CHOKER	BASKET
ONE PLY				
TC1-702	TT1-702	2,400	1,900	4,800
TC1-703	TT1-703	3,600	2,900	7,200
TC1-704	TT1-704	4,800	3,800	9,600
TC1-706	TT1-706	7,200	5,800	14,400
TWO PLY				
TC2-702	TT2-702	4,800	3,800	9,600
TC2-703	TT2-703	6,500	5,200	13,000
TC2-704	TT2-704	8,600	6,900	17,200
TC2-706	TT2-706	12,600	10,100	25,200

* Type 2 can not be used in a choker hitch.

Note:

Hardware – Aluminum hardware is available on single ply types 1 and 2 slings in 2", 3", 4" and 6" widths.



Nylon and Polyester Web Slings



**type
3**
eye & eye
flat

**type
4**
eye & eye
twist

HEAVY DUTY

TYPE 3 FLAT EYE	TYPE 4 TWISTED EYE	RATED CAPACITIES IN POUNDS		
		VERTICAL	CHOKER	BASKET
EE1-901		1,600	1,250	3,200
EE1-902		3,200	2,500	6,400
EE1-903		4,800	3,800	9,600
EE1-904		6,400	5,000	12,800
EE1-906		9,600	7,700	19,200
EE1-908		12,800	10,200	25,600
EE1-910		16,000	12,800	32,000
EE1-912		19,200	15,400	38,400
EE2-901		3,200	2,500	6,400
EE2-902		6,400	5,000	12,800
EE2-903		8,600	6,900	17,200
EE2-904		11,500	9,200	23,000
EE2-906		16,300	13,000	32,600
EE2-908		19,200	15,400	38,400
EE2-910		22,400	17,900	44,800
EE2-912		26,900	21,500	53,800
EE3-901		4,100	3,300	8,200
EE3-902		8,300	6,600	16,600
EE3-903		12,500	10,000	25,000
EE3-904		16,000	12,800	32,000
EE3-906		23,000	18,400	46,000
EE3-908		30,700	24,500	61,400
EE3-910		36,800	29,400	73,600
EE3-912		44,000	35,200	88,000
EE4-901		5,000	4,000	10,000
EE4-902		10,000	8,000	20,000
EE4-903		14,900	11,900	29,800
EE4-904		19,800	15,800	39,600
EE4-906		29,800	23,800	59,600
EE4-908		39,700	31,700	79,400
EE4-910		49,600	39,600	99,200
EE4-912		59,500	47,600	119,000



Note:

Tapering – types 3 and 4 are tapered at 3” and wider unless otherwise ordered. These wider slings are tapered at the bearing points to accommodate a crane hook.

LIGHT DUTY

TYPE 3 FLAT EYE	TYPE 4 TWISTED EYE	RATED CAPACITIES IN POUNDS		
		VERTICAL	CHOKER	BASKET
ONE PLY				
EE1-701		1,200	950	2,400
EE1-702		2,400	1,900	4,800
EE1-703		3,600	2,900	7,200
EE1-704		4,800	3,800	9,600
EE1-706		7,200	5,800	14,400
TWO PLY				
EE2-701		2,400	1,900	4,800
EE2-702		4,800	3,800	9,600
EE2-703		6,500	5,200	13,000
EE2-704		8,600	6,900	17,200
EE2-706		12,200	9,800	24,400
THREE PLY				
EE3-701		3,500	2,800	7,000
EE3-702		7,000	5,600	14,000
EE3-703		9,400	7,500	18,800
EE3-704		12,000	9,600	24,000
EE3-706		18,000	14,400	36,000
FOUR PLY				
EE4-701		4,200	3,400	8,400
EE4-702		8,000	6,400	16,000
EE4-703		12,000	9,600	24,000
EE4-704		16,000	12,800	32,000
EE4-706		23,500	18,800	47,000

Eye Length Chart

Sling Width	Plies of Webbing			
	1	2	3	4
1”	9”	9”	12”	12”
2”	9”	9”	12”	12”
3”	12”	12”	18”	18”
4”	12”	12”	18”	18”
5”	15”	15”	20”	20”
6”	18”	18”	24”	24”
8”	24”	24”	30”	30”
10”	30”	30”	36”	36”
12”	30”	30”	36”	36”

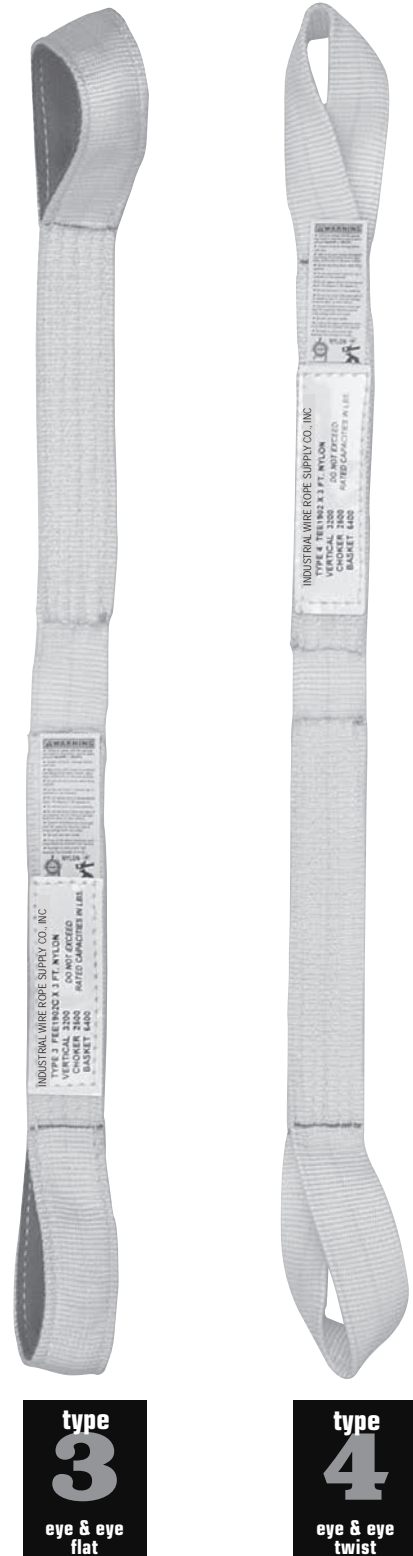



Nylon and Polyester Web Slings



type
5
endless
or grommet

HEAVY DUTY

TYPE 5 (EN)	RATED CAPACITIES IN LBS.		
	VERTICAL	CHOKER	BASKET
ONE PLY			
EN1-901	3,200	2,500	6,400
EN1-902	6,400	5,000	12,800
EN1-903	8,600	6,900	17,200
EN1-904	11,500	9,200	23,000
EN1-906	16,300	13,000	32,600
EN1-908	19,200	15,400	38,400
EN1-910	22,400	17,900	44,800
EN1-912	26,900	21,500	53,800
TWO PLY			
EN2-901	6,200	4,900	12,400
EN2-902	12,200	9,800	24,400
EN2-903	16,300	13,000	32,600
EN2-904	20,700	16,500	41,400
EN2-906	28,600	23,000	57,200
EN2-908	30,700	24,500	61,400
EN2-910	33,600	26,800	67,200
EN2-912	37,600	30,000	75,200
THREE PLY			
EN3-901	8,000	6,400	16,000
EN3-902	16,000	12,800	32,000
EN3-903	21,500	17,200	43,000
EN3-904	28,700	23,000	57,400
EN3-906	40,700	32,500	81,400
EN3-908	46,000	36,800	92,000
EN3-910	51,500	41,200	103,000
EN3-912	59,200	47,300	118,400
FOUR PLY			
EN4-901	10,000	8,000	20,000
EN4-902	19,800	15,800	39,600
EN4-903	26,700	21,300	53,400
EN4-904	35,600	28,400	71,200
EN4-906	50,500	40,400	101,000
EN4-908	57,600	46,000	115,200
EN4-910	67,200	53,700	134,400
EN4-912	80,700	64,500	161,400

LIGHT DUTY

TYPE 5 (EN)	RATED CAPACITIES IN LBS.		
	VERTICAL	CHOKER	BASKET
ONE PLY			
EN1-701	2,400	1,900	4,800
EN1-702	4,800	3,800	9,600
EN1-703	6,500	5,200	13,000
EN1-704	8,600	6,900	17,200
EN1-706	12,200	9,800	24,400
TWO PLY			
EN2-701	4,800	3,800	9,600
EN2-702	9,600	7,700	19,200
EN2-703	11,700	9,400	23,400
EN2-704	15,500	12,400	31,000
EN2-706	22,500	18,000	45,000
THREE PLY			
EN3-701	6,200	4,900	12,400
EN3-702	12,500	10,000	25,000
EN3-703	16,300	13,000	32,600
EN3-704	20,600	16,400	41,200
EN3-706	29,300	23,400	58,600
FOUR PLY			
EN4-701	7,700	6,200	15,400
EN4-702	15,500	12,400	31,000
EN4-703	20,800	16,600	41,600
EN4-704	26,600	21,200	53,200
EN4-706	37,800	30,200	75,600



Cordura Lined Reversed Eye Slings



HEAVY DUTY

TYPE 6 (RE)	VERTICAL	CHOKER	BASKET	SLING WIDTH	EYE LENGTH
ONE PLY					
RE1-902	4,500	3,600	9,000	2	9
RE1-904	7,700	6,200	15,400	4	15
RE1-906	11,000	8,800	22,000	6	15
TWO PLY					
RE2-902	6,500	5,200	13,000	2	9
RE2-904	13,000	10,400	26,000	4	15
RE2-906	20,000	16,000	40,000	6	15
THREE PLY					
RE3-904	16,400	13,100	32,800	4	15
RE3-906	25,500	20,400	51,000	6	15
FOUR PLY					
RE4-906	34,000	27,200	68,000	6	15



LIGHT DUTY

TYPE 6 (RE)	VERTICAL	CHOKER	BASKET	SLING WIDTH	EYE LENGTH
ONE PLY					
RE1-702	3,600	2,900	7,200	2	9
RE1-704	6,800	5,400	13,600	4	15
RE1-706	8,000	6,400	16,000	6	15
TWO PLY					
RE2-702	5,200	4,200	10,400	2	9
RE2-704	10,500	8,400	21,000	4	15
RE2-706	14,400	11,500	28,000	6	15
THREE PLY					
RE3-704	14,000	11,200	28,000	4	15
RE3-706	20,000	16,000	40,000	6	15

Wide Body Basket

When surface area is more critical than weight capacity, a wide body basket is the preferred alternative. A wide body basket is also an economical approach to load balancing. Contact a IRSCI specialist for more information on Wide Body and Load Balancing Baskets.



Multi-leg Bridle

A multi-leg bridle can be manufactured from either flat web or polyester round slings. IRSCI application specialists are available to assist in determining the best configuration for your lifting requirements.



5



Round Slings

Tubular Polyester Round Slings

Lift Capacities according to polyester round sling type (color) and hitch used.

CODE	COLOR	CAPACITIES IN LBS.			
		VERTICAL	CHOKER	BASKET	MINIMUM LENGTH
SWG30	PURPLE	2,650	2,120	5,300	3 ft.
SWG60	GREEN	5,300	4,240	10,600	3 ft.
SWG90	YELLOW	8,400	6,720	16,800	3 ft.
SWG120	TAN	10,600	8,500	21,200	3 ft.
SWG150	RED	13,200	10,560	26,400	3 ft.
SWG180	ORANGE	16,800	13,440	33,600	3 ft.
SWG240	BLUE	21,200	17,000	42,400	3 ft.
SWG300	ORANGE	25,000	20,000	50,000	3 ft.
SWG360	GREY	31,700	25,300	63,400	3 ft.
SWG500	ORANGE	40,000	32,000	80,000	3 ft.
SWG600	BROWN	52,900	42,300	105,800	6 ft.
SWG800	OLIVE	66,100	52,880	132,200	6 ft.
SWG1000	BLACK	90,000	72,000	180,000	6 ft.

Removal from Service

A polyester round sling shall be removed from service if any of the following is visible:

- If polyester round slings identification tag is missing or unreadable.
- Melting, charring or weld spatter of any part of the polyester round sling.
- Holes, tears cuts, embedded particles, abrasive wear, or snags that expose the core fibers of the polyester round sling.
- Broken or worn stitching in the cover which exposes the core fibers.
- Fittings when damaged, stretched or distorted in any way.
- Polyester round slings that are knotted.
- Acid or alkalis burns of the polyester round sling.
- Any conditions which cause doubt as to the strength of the polyester round sling.

8 Part Braided Round Slings

CODE	COLOR	RATED CAPACITIES (LBS.)				APPROXIMATE MEASUREMENTS				
		VERTICAL	CHOKER	BASKET	MINIMUM LENGTH (FT.)	WEIGHT (LBS./FT.)	STANDARD EYE (EL) (IN.)	WIDTH AT LOAD (W) (IN.)	THICKNESS AT LOAD (IN.)	EYE DIA. (IN.)
SWG30	PURPLE	8,800	7,100	17,600	4 1/2	1.1	15	3 1/2	1	1 3/4
SWG60	GREEN	18,000	14,400	36,000	5	1.5	15	4	1 9/8	2
SWG90	YELLOW	28,500	22,800	57,000	5 1/2	2.2	15	4 3/4	1 5/8	2 1/2
SWG120	TAN	36,000	28,800	72,000	5 1/2	2.6	15	5	1 3/4	2 1/2
SWG150	RED	44,900	35,900	89,800	6 1/2	3.6	20	6	2 1/6	2 3/4
SWG180	ORANGE	57,100	45,600	114,200	7	4.1	20	6 1/4	2 1/2	3 1/4
SWG240	BLUE	72,000	57,600	144,000	9	5.6	20	7 1/2	2 3/4	3 3/4
SWG360	GREY	105,400	84,300	210,800	9 1/2	8.3	30	9 1/2	3 1/4	4 1/2
SWG600	BROWN	180,200	144,100	360,400	10 1/2	12.0	30	13	3 3/4	5 1/2
SWG800	OLIVE	224,400	179,500	448,800	13	16.0	30	13 1/2	4 1/2	6
SWG1000	BLACK	306,000	244,000	612,000	14 1/2	20.0	31	15 3/4	5 1/4	6 1/2

5

Endless and Eye & Eye styles of Round Slings are made to a tolerance of ± 1% of the specified length (± 1" minimum tolerance) and can stretch 3% at rated capacity.

Braided Round Slings length tolerance is ± 5% of the ordered length (sling at rest). At its rated capacity, braided Round Slings will stretch approximately 9%.

**Note: Matched lengths of slings must be specified at time of order.
Higher capacity round slings available upon request.**



Wear Pads

SCUFF EDGE™

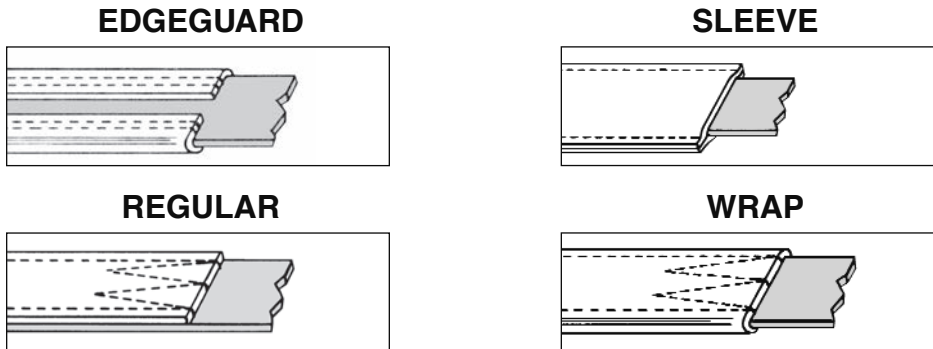

Truck Tiedowns

Polyester Webbing

- 27' and 30' Standard Lengths
- Fits Standard 3" & 4" Winches
- Manufactured to Customer Order
- Corner Protectors, Sliding Sleeves Available
- Meets or Exceeds California and Federal Regulations

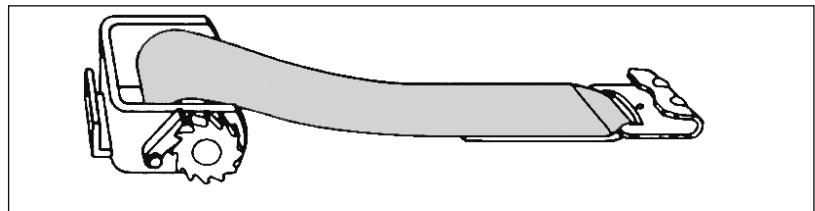

Ratchet Snugger (Truck Tiedown)

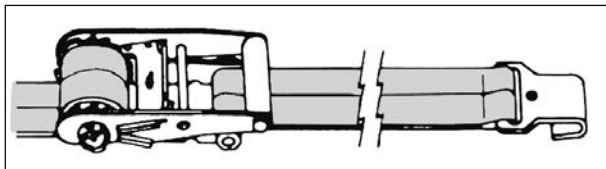

Size	W.L.L.
1" X 10' W/Ratchet	1500
1" X 12' W/Ratchet	1500
2" X 27' W/Ratchet	3300
3" X 27' W/Ratchet	5000
4" X 27' W/Ratchet	5000

Replacement Strap for Standard Truck Tiedowns

Size	W.L.L.
3"	5000
4"	5000

Length to your requirements

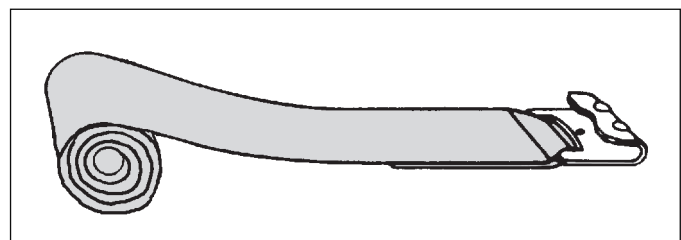



GUARDIAN
FALL PROTECTION



**INDUSTRIAL WIRE ROPE SUPPLY COMPANY INC.
PROUDLY SUPPLIES AND REPAIRS
GUARDIAN FALL PROTECTION**

5

SUPPLYING FALL PROTECTION

Industrial Wire Rope Supply Company Inc. carries quality fall protection solutions.
• Anchors • Harnesses • Self-Retracting Lifelines • Lanyards • Safety kits • And more

REPAIRING FALL PROTECTION

Industrial Wire Rope Supply Company Inc. is a certified repair center for all Guardian Fall Protection self-retracting lifelines.

Miscellaneous

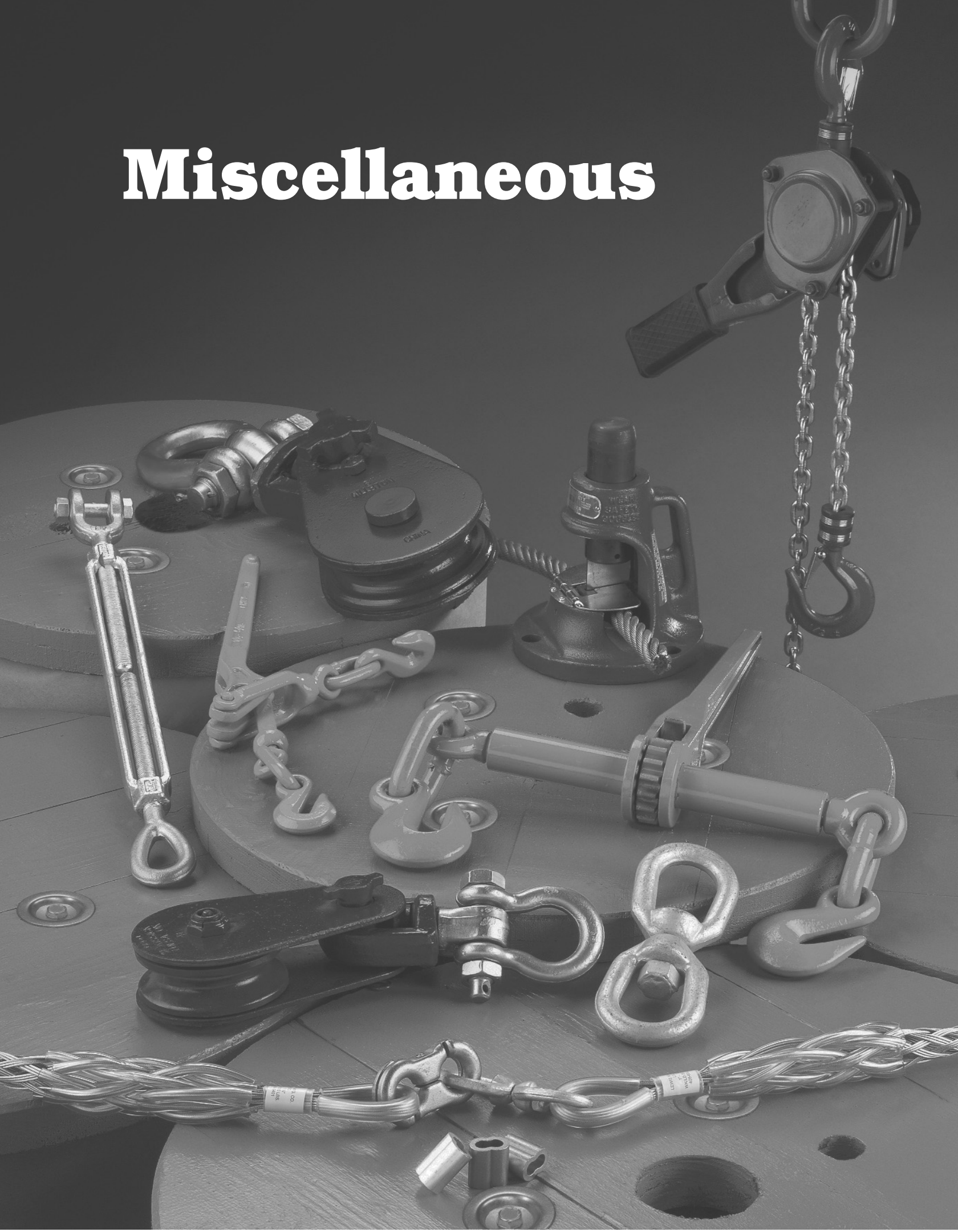



Available From Stock For Immediate Delivery

Custom Made - To Order

CHAIN HOIST

Call for information:

513-941-2443

636-255-0600



**LEVER HOIST
1/2 TON - 6 TON**



**CHAIN LIFT
1/2 TON - 10 TON**

Larger Hoists Available Upon Request

WIRE ROPE HOIST

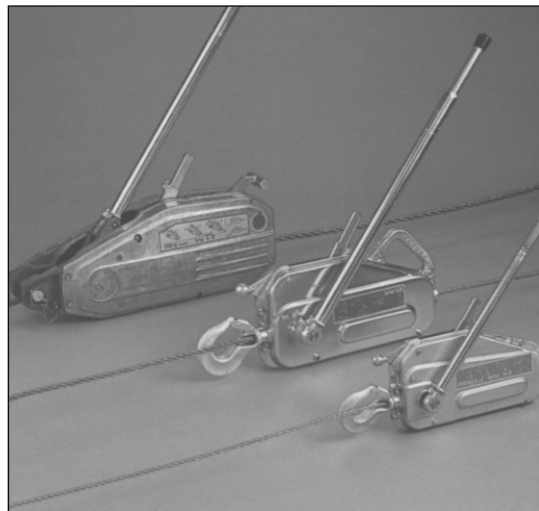

Or Call Toll Free:

Cincinnati, Ohio (888) 345-0919

St. Charles, Missouri (866) 852-9714



McKissick® Overhaul Balls

UB500 SERIES TOP SWIVELING OVERHAUL BALLS



S320 or S320N
Eye Hook



S1316A
SHUR-LOC®
Eye Hook



Both styles available with
optional McKissick®
Wedge Socket Assembly
or S-421 TERMINATOR™
Wedgs Socket



UWO 422T
TERMINATOR™
Wedge Only

- Sizes 4 tons through 10 tons available with Crosby’s S1316A “Positive Locking” SHUR-LOC® hook which may be used for lifting personnel. Meets the intent of OSHA Rule 1926.1431(g)(1)(i)(A) and 1926.1501(g)(4)(iv)(B).
- Design Factor 4:1.
- The top swivel design on the UB500 assures the ball remains stationary if the wire line spins.
- The swivel incorporates a sealed roller thrust bearing together with a grease fitting for easy lubrication.
- Each ball can be equipped with the new McKissick® US-422T Wedge Socket which can be easily adjusted to fit

- various sizes of wire rope by changing the wedge (Ensure that correct wedge is used for selected wire rope size).
- All hooks used on UB500 Overhaul Balls (S320, S320N & S1316A) are forged from alloy steel. The S320 and S320N hooks come complete with latches.
- The S320 hook (PL latch) and the S320N hook (S4320 latch), with the proper latch attached, may be used for personnel lifting when secured with proper device (Bolt, nut and pin for the PL latch; Cotter pin for the S4320 latch). Meets the intent of OSHA Rule 1926.1431(g)(1)(i)(A) and 1926.1501(g)(4)(iv)(B).

Overhaul Ball Assembly					Optional US-422T Wedge Sockets					
McKissick® UB500 Model No.	UB500 “E” Eye Hook Stock No.	UB500 “S” SHUR-LOC® Stock No.	Working Load Limit (tons)	Weight Each (lbs.)	Wire Rope Size (in.)	Model No.	Wedge Socket Assy. Stock No.	Weight Each (lbs.)	Wedge Only Stock No.	Weight Each (lbs.)
MB4T35	1036000*	1036005	4	58	3/8	US4T	1044300	4.6	1047310	0.6
MB4T85	1036009*	1036018	4	102	7/16	US4T	1044309	4.6	1047301	0.6
MB4T150	1036027*	1036032	4	162	1/2	US4T	1044318	4.6	1047329	0.6
MB4T200	1036036*	1036041	4	201	1/2	US5T	1044327	8.5	1047338	1.0
MB7T85	1036045*	1036050	7	109	9/16	US5T	1044336	8.5	1047347	1.0
MB7T150	1036054*	1036063	7	170	5/8	US5T	1044345	8.5	1047356	1.0
MB7T200	1036072*	1036077	7	210	5/8	US6T	1044354	9.4	1047365	1.4
MB7T285	1036081*	1036086	7	321	3/4	US6T	1044363	9.4	1047374	1.4
MB10T150	1036090*	1036095	10	216						
MB10T200	1036099*	1036108	10	260						
MB10T285	1036117*	1036122	10	365	5/8	US6T	1044354	9.4	1047365	2.3
MB10T350	1036126*	1036131	10	403	3/4	US6T	1044363	9.4	1047374	2.4
MB10T650	1036135*	1036140	10	718	7/8	US8T	1044404	20.8	1047425	5.3
MB12T150	1036144*	1036520	12	216	1	US8T	1044417	20.8	1047431	6.0
MB12T200	1036153*	1036529	12	258	1-1/8	US10T	1044426	46.5	1047440	9.6
MB12T285	1036171*	1036538	12	365	1-1/4	US10T	1044435	46.5	1047459	10.5
MB12T350	1036180*	1036547	12	403						
MB12T650	1036189*	1036556	12	718						
MB15T200	1036198*	1036565	15	298						
MB15T350	1036207*	1036574	15	456						
MB15T650	1036216*	1036583	15	753						
MB15T1150	1036225*	1036592	15	1311						
MB20T200	1036234*	1036611	20	298	5/8	US8AT	1044372	17.5	1047383	3.1
MB20T350	1036243*	1036620	20	456	3/4	US8AT	1044381	17.5	1047392	3.4
MB20T650	1036252*	1036629	20	753	7/8	US8T	1044404	20.8	1047425	5.3
MB20T1150	1036261*	1036638	20	1311	1	US8T	1044417	20.8	1047431	6.0
MB25T350	1036270	1036647	25	533	1-1/8	US10T	1044426	46.5	1047440	9.6
MB25T650	1036279	1036656	25	865	1-1/4	US10T	1044435	46.5	1047459	10.5
MB25T1150	1036288	1036665	25	1421						
MB30T650	1036297	1036674	30	865						
MB30T1150	1036306	1036683	30	1421						

* Utilizes Crosby “N” style hooks with integrated latch. Replacement latch kit is S-4320. PL latch and S-4055 latch will not fit. Standard Crosby S-5 Thrust style swivels can not be used with UB500 Overhaul Balls. For replacement swivels, contact Crosby Customer Service.



McKissick® Overhaul Balls

UB-500 TOP SWIVEL OVERHAUL BALLS

UB-500E Top Swivel Overhaul Balls with 320 Eye Hooks

- All sizes are RFID EQUIPPED.

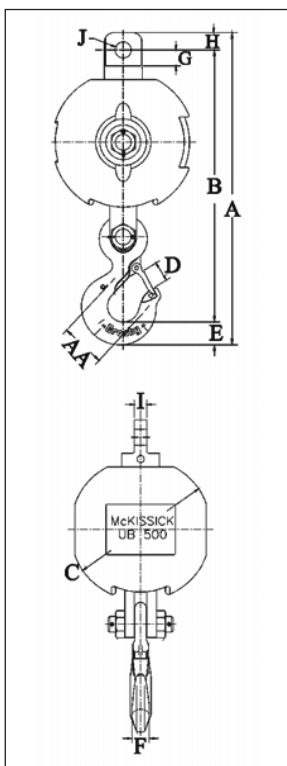

Model No.*	UB-500 "E" Stock No.	Dimensions (in.)										
		A	B	C	D	E	F	G	H	I	J	AA
MB4T35*	1036000	20.09	17.27	7.50	1.36	1.44	1.12	1.88	1.38	.88	1.31	2.5
MB4T85*	1036009	20.98	18.16	9.25	1.36	1.44	1.12	1.88	1.38	.88	1.31	2.5
MB4T150*	1036027	21.98	19.16	11.25	1.36	1.44	1.12	1.88	1.38	.88	1.31	2.5
MB4T200*	1036036	22.35	19.53	12.50	1.36	1.44	1.12	1.88	1.38	.88	1.31	2.5
MB7T85*	1036045	23.18	20.36	9.25	1.61	1.81	1.38	1.88	1.38	.88	1.31	3.0
MB7T150*	1036054	24.56	21.36	11.25	1.61	1.81	1.38	1.88	1.38	.88	1.31	3.0
MB7T200*	1036072	24.89	21.71	12.50	1.61	1.81	1.38	1.88	1.38	.88	1.31	3.0
MB7T285*	1036081	25.86	22.67	13.88	1.61	1.81	1.38	1.88	1.38	.88	1.31	3.0
MB10T150*	1036090	31.44	27.19	11.25	2.08	2.25	1.62	2.75	2.00	1.25	1.78	4.0
MB10T200*	1036099	31.81	27.56	12.50	2.08	2.25	1.62	2.75	2.00	1.25	1.78	4.0
MB10T285*	1036117	32.75	28.50	13.88	2.08	2.25	1.62	2.75	2.00	1.25	1.78	4.0
MB10T350*	1036126	33.31	29.06	15.00	2.08	2.25	1.62	2.75	2.00	1.25	1.78	4.0
MB10T650*	1036135	34.79	30.54	17.94	2.08	2.25	1.62	2.75	2.00	1.25	1.78	4.0
MB12T150*	1036144	31.44	27.19	11.25	2.08	2.25	1.62	2.75	2.00	1.25	1.78	4.0
MB12T200*	1036153	31.81	27.56	12.50	2.08	2.25	1.62	2.75	2.00	1.25	1.78	4.0
MB12T285*	1036171	32.75	28.50	13.88	2.08	2.25	1.62	2.75	2.00	1.25	1.78	4.0
MB12T350*	1036180	33.31	29.06	15.00	2.08	2.25	1.62	2.75	2.00	1.25	1.78	4.0
MB12T650*	1036189	35.79	30.54	17.94	2.08	2.25	1.62	2.75	2.00	1.25	1.78	4.0
MB15T200*	1036198	37.59	32.59	12.50	3.02	3.00	2.38	2.38	2.00	1.25	1.78	5.0
MB15T350*	1036207	38.81	33.81	15.00	3.02	3.00	2.38	2.38	2.00	1.25	1.78	5.0
MB15T650*	1036216	40.22	35.22	17.94	3.02	3.00	2.38	2.38	2.00	1.25	1.78	5.0
MB15T1150*	1036225	42.22	37.22	21.62	3.02	3.00	2.38	2.38	2.00	1.25	1.78	5.0
MB20T200*	1036234	37.59	32.59	12.50	3.02	3.00	2.38	2.38	2.00	1.25	1.78	5.0
MB20T350*	1036243	38.81	33.81	15.00	3.02	3.00	2.38	2.38	2.00	1.25	1.78	5.0
MB20T650*	1036252	40.22	35.22	17.94	3.02	3.00	2.38	2.38	2.00	1.25	1.78	5.0
MB20T1150*	1036261	42.22	37.22	21.62	3.02	3.00	2.38	2.38	2.00	1.25	1.78	5.0
MB25T350	1036270	47.18	40.18	15.00	3.00	3.62	3.00	3.31	2.75	1.75	1.78	6.5
MB25T650	1036279	49.12	42.75	17.94	3.00	3.62	3.00	3.31	2.75	1.75	1.78	6.5
MB25T1150	1036288	51.06	44.69	21.62	3.00	3.62	3.00	3.31	2.75	1.75	1.78	6.5
MB30T650	1036297	49.12	42.75	17.94	3.00	3.62	3.00	3.31	2.75	1.75	1.78	6.5
MB30T1150	1036306	51.06	44.69	21.62	3.00	3.62	3.00	3.31	2.75	1.75	1.78	6.5

* 4 ton thru 20 ton models use Crosby "N" style hooks with integrated latch.

UB-500S Top Swivel Overhaul Balls with SHUR-LOC® Hooks

- All sizes are RFID EQUIPPED.

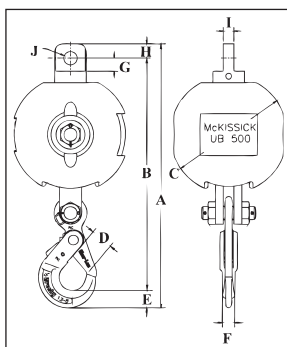

Model No.	UB-500 "S" Stock No.	Dimensions (in.)									
		A	B	C	D	E	F	G	H	I	J
MB4T35	1036005	20.66	18.18	7.50	1.83	1.15	.94	1.88	1.38	.88	1.31
MB4T85	1036018	21.55	19.05	9.25	1.83	1.15	.94	1.88	1.38	.88	1.31
MB4T150	1036032	22.55	20.05	11.25	1.83	1.15	.94	1.88	1.38	.88	1.31
MB4T200	1036041	22.92	20.42	12.50	1.83	1.15	.94	1.88	1.38	.88	1.31
MB7T85	1036050	23.90	21.30	9.25	2.11	1.66	1.16	1.88	1.38	.88	1.31
MB7T150	1036063	25.28	22.30	11.25	2.11	1.66	1.16	1.88	1.38	.88	1.31
MB7T200	1036077	25.61	22.65	12.50	2.11	1.66	1.16	1.88	1.38	.88	1.31
MB7T285	1036086	26.58	23.61	13.88	2.11	1.66	1.16	1.88	1.38	.88	1.31
MB10T150	1036095	31.24	27.19	11.25	2.49	2.06	1.50	2.75	2.00	1.25	1.78
MB10T200	1036108	31.61	27.56	12.50	2.49	2.06	1.50	2.75	2.00	1.25	1.78
MB10T285	1036122	32.55	28.50	13.88	2.49	2.06	1.50	2.75	2.00	1.25	1.78
MB10T350	1036131	33.11	29.06	15.00	2.49	2.06	1.50	2.75	2.00	1.25	1.78
MB10T650	1036140	34.59	30.54	17.94	2.49	2.06	1.50	2.75	2.00	1.25	1.78



McKissick® Snatch Blocks

Fatigue Rated



418 WITH HOOK



New Improved Light Champion

- Forged alloy heat treated hooks.
- Forged steel swivel tees, yokes and shackles.
- Hook and shackle assemblies on 4-1/2" through 14" sizes can be interchanged.
- Can be furnished with bronze bushings or roller bearings.
- Opening feature permits insertion of rope while block is suspended from gin-pole.
- 3" thru 18" 418 and 419 blocks have exclusive bolt retaining spring to assure no lost bolts.
- Can be furnished with S-4320 hook latch.
- Pressure lube fittings.
- 3" - 10" feature dual rated wireline sheaves.
- Fatigue rated.
- 4-1/2" and larger are **RFID EQUIPPED**.
- Meets or exceeds all requirements of ASME B30.26 including identification, ductility, design factor, proof load and temperature requirements. Importantly, these blocks meet other critical performance requirements including fatigue life, impact properties and material traceability, not addressed by ASME B30.26.

419 WITH SHACKLE



418 / 419 / 404 Snatch Blocks

Sheave Diameter (in.)	Bearing Code	Stock No.			Wire Rope Size (in.) ‡	Working Load Limit (t)*	Weight Each (lbs.)			Rep. Sheave Stock No.	Rep. Latch Stock No.
		418 with Hook	419 with Shackle	404 Tail Board			418 with Hook	419 with Shackle	404 Tail Board		
** 3	BB	-	109091	-	5/16 - 3/8	2	-	4	-	460147	-
** 3	BB	108038	109037 †	102016	5/16 - 3/8	2	5	4	3	460147	1096421
**4-1/2	BB	108065	109064	102025	3/8 - 1/2	4	12	12	7	2000232	1096468
6	BB	108127	109126	102098	5/8 - 3/4	8	27	28	15	460815	1096562
6	RB	108154	109153	102114	5/8 - 3/4	8	27	28	15	472688	1096562
8	BB	108225	109224	102169	5/8 - 3/4	8	33	34	21	461164	1096562
8	RB	108252	109251	102187	5/8 - 3/4	8	33	34	21	473277	1096562
10	BB	108323	109322	102230	5/8 - 3/4	8	41	42	29	461805	1096562
10	RB	108350	109359	102258	5/8 - 3/4	8	41	42	29	473776	1096562
12	BB	169169	202961	178890	5/8	8	48	49	36	462270	1096562
12	RB	199911	169347	178934	5/8	8	48	49	36	474141	1096562
12	BB	108421	109420	102301	3/4	8	48	49	36	462289	1096562
12	RB	108458	109457	102329	3/4	8	48	49	36	474150	1096562
14	BB	194920	169356	-	5/8	8	55	56	-	463625	1096562
14	RB	199948	167857	-	5/8	8	55	56	-	474766	1096562
14	BB	108528	109527	-	3/4	8	55	56	-	463634	1096562
14	RB	108546	109545	-	3/4	8	55	56	-	474775	1096562
16	BB	199975	203041	-	3/4	15	130	135	-	4100056	1096609
16	RB	200008	203087	-	3/4	15	130	135	-	4200028	1096609
16	BB	108608	109607	-	7/8	15	130	135	-	4100065	1096609
16	RB	108626	109625	-	7/8	15	130	135	-	4200037	1096609
18	BB	200099	203130	-	7/8	15	150	155	-	464571	1096609
18	RB	200151	203176	-	7/8	15	150	155	-	475792	1096609
18	BB	108644	109643	-	1	15	150	155	-	4104640	1096609
18	RB	108662	109661	-	1	15	150	155	-	6000000	1096609

404 TAIL BOARD



* Ultimate Load is 4 times the Working Load Limit.

** Available in Bronze Bushed only. 3" and 4-1/2" have self lubricating Bronze Bushing.

† Fitted with 1-1/4" ID Swivel Eye.

‡ May be furnished in other rope sizes.

NOTE: When ordering, please specify: size, block number, hook or shackle, bronze bushed or roller bearing, and wire rope size.

NOTE: Tail Board does not contain the spool that is required with the hook (418) and shackle (419) snatch blocks.



McKissick® Snatch Blocks

Fatigue Rated



**420
WITH HOOK**



Champion

- Hooks and side plates are forged alloy steel and heat treated.
- Shackles and yokes are forged and heat treated steel.
- All parts are forged.
- Side plates are designed to eliminate possibility of rope jamming.
- Can be furnished with bronze bushings or sealed roller bearings.
- Opening feature permits insertion of rope while block is suspended from gin-pole.
- Can be furnished with S-4320 hook latch.
- Pressure lube fittings.
- Hook and shackle assemblies can be interchanged.
- Blocks furnished with dual rated wireline sheaves.
- Fatigue Rated.
- All sizes are **RFID EQUIPPED**.
- Meets or exceeds all requirements of ASME B30.26 including identification, ductility, design factor, proof load and temperature requirements. Importantly, these blocks meet other critical performance requirements including fatigue life, impact properties and material traceability, not addressed by ASME B30.26.

**421
WITH SHACKLE**



420 / 421 / 406 Snatch Blocks

Sheave Diameter (in.)	Bearing Code	Stock No.			Wire Rope Size (in.) †	Working Load Limit (t)*	Weight Each (lbs.)			Rep. Sheave Stock No.	Rep. Latch Stock No.
		420 with Hook	421 with Shackle	406 Tail Board			420 with Hook	421 with Shackle	406 Tail Board		
6	BB	169374	169481	167973	3/4 - 7/8	12	40	48	24	460940	1096609
6	RB	169392	204120	167982	3/4 - 7/8	12	40	48	24	473035	1096609
8	BB	169418	169515	167991	3/4 - 7/8	15	51	57	30	461360	1096609
8	RB	169445	204193	168008	3/4 - 7/8	15	51	57	30	473534	1096609
10	BB	110221	110720	103186	3/4 - 7/8	15	63	69	42	462001	1096609
10	RB	110258	110757	103202	3/4 - 7/8	15	63	69	42	474025	1096609

* Ultimate Load is 4 times the Working Load Limit.

† May be furnished in other rope sizes.

NOTE: When ordering, please specify: size, block number, hook or shackle, bronze bushed or roller bearing, and wire rope size.

NOTE: Tail Board does not contain the spool that is required with the hook (420) and shackle (421) snatch blocks.

**406
TAIL BOARD**





McKissick® Snatch Blocks

Fatigue Rated



430 WITH HOOK



Super Champion

- Drop forged, heat treated swivel hook or swivel shackle.
- Hook and shackle assemblies on 8" through 14" sizes can be interchanged.
- Can be furnished with bronze bushings or roller bearings.
- Pressure lube fittings.
- 430 and 431 blocks have exclusive bolt retaining spring to assure no lost bolts.
- Can be furnished with hook latch.
- 8" and 10" models furnished with dual rated wireline sheaves.
- Fatigue Rated.
- All sizes are **RFID EQUIPPED**.
- Meets or exceeds all requirements of ASME B30.26 including identification, ductility, design factor, proof load and temperature requirements. Importantly, these blocks meet other critical performance requirements including fatigue life, impact properties and material traceability, not addressed by ASME B30.26.

431 WITH SHACKLE



430 / 431 / 407 Snatch Blocks

Sheave Diameter (in.)	Bearing Code	Stock No.			Wire Rope Size (in.)	Working Load Limit (t)*	Weight Each (lbs.)			Rep. Sheave Stock No.	Rep. Latch Stock No.
		430 with Hook	431 with Shackle	407 Tail Board			430 with Hook	431 with Shackle	407 Tail Board		
8	BB	120023	121022	103523	1 - 1-1/8	20	75	87	42	461440	1096657
8	RB	120041	121040	103541	1 - 1-1/8	20	75	87	42	473614	1096657
10	BB	120096	121095	103603	1 - 1-1/8	20	89	101	55	462083	1096657
10	RB	120112	121111	103621	1 - 1-1/8	20	89	101	55	474105	1096657
12	BB	208536	169917	184375	1	20	103	115	70	462680	1096657
12	RB	208554	209303	184393	1	20	103	115	70	474524	1096657
12	BB	120176	121175	103685	1-1/8	20	103	115	70	462699	1096657
12	RB	120194	121193	103701	1-1/8	20	103	115	70	474533	1096657
14	BB	208572	209321	184419	1	20	123	135	90	463457	1096657
14	RB	208590	170424	184437	1	20	123	135	90	475024	1096657
14	BB	120256	121255	103765	1-1/8	20	123	135	90	463466	1096657
14	RB	120274	121273	103783	1-1/8	20	123	135	90	475033	1096657
18	BB	208689	209410	184552	1	25	240	260	165	4100298	1090143
18	RB	208732	209465	184605	1	25	240	260	165	4200331	1090143
18	BB	119482	119561	119641	1-1/8	25	240	260	165	4103348	1090143
18	RB	119491	119570	119650	1-1/8	25	240	260	165	4200322	1090143
20	BB	208750	209483	184623	1-1/8	30	375	400	215	4103936	1090189
20	RB	208787	169864	184650	1-1/8	30	375	400	215	4200769	1090189
20	BB	119507	119589	119669	1-1/4	30	375	400	215	4103945	1090189
20	RB	119516	119598	119678	1-1/4	30	375	400	215	4200778	1090189
24	BB	208812	209526	184687	1-1/8	30	450	475	290	4104114	1090189
24	RB	208858	209553	184721	1-1/8	30	450	475	290	4200983	1090189
24	BB	119525	119605	119687	1-1/4	30	450	475	290	4104123	1090189
24	RB	119534	119614	119696	1-1/4	30	450	475	290	4200992	1090189

* Ultimate Load is 4 times the Working Load Limit.

† May be furnished in other rope sizes.

NOTE: When ordering, please specify: size, block number, hook or shackle, bronze bushed or roller bearing, and wire rope size.

NOTE: Tail Board does not contain the spool that is required with the hook (430) and shackle (431) snatch blocks.

407 TAIL BOARD



McKissick® Snatch Blocks

Fatigue Rated



408 WITH HOOK



Light Champion Double Sheave

- Light champion snatch block as a double sheave block.
- Drop forged swivel hook or swivel shackle.
- Can be furnished with bronze bushings or roller bearings.
- Opening feature permits easy insertion of wire rope in both sheaves with removal of one bolt.
- Can be furnished with S-4320 hook latch.
- Pressure lube fittings.
- 4-1/2" - 10" models furnished with dual rated wireline sheaves.
- Fatigue Rated.
- All sizes are **RFID EQUIPPED**.
- Meets or exceeds all requirements of ASME B30.26 including identification, ductility, design factor, proof load and temperature requirements. Importantly, these blocks meet other critical performance requirements including fatigue life, impact properties and material traceability, not addressed by ASME B30.26.

409 WITH SHACKLE



408 / 409 Snatch Blocks

Sheave Diameter (in.)	Bearing Code	Stock No.		Wire Rope Size (in.) ‡	Working Load Limit (t)*	Weight Each (lbs.)		Rep. Sheave Stock No.	Rep. Latch Stock No.
		408 with Hook	409 with Shackle			408 with Hook	409 with Shackle		
† 4-1/2	BB	104023	105022	3/8 - 1/2	4	18	18	2000232	1096468
6	BB	104103	105102	5/8 - 3/4	12	45	50	460815	1096609
6	RB	104121	105120	5/8 - 3/4	12	45	50	472688	1096609
8	BB	104185	105184	5/8 - 3/4	12	53	58	461164	1096609
8	RB	104201	105200	5/8 - 3/4	12	53	58	473277	1096609
10	BB	104265	105264	5/8 - 3/4	12	70	75	461805	1096609
10	RB	104283	105282	5/8 - 3/4	12	70	75	473776	1096609
12	BB	194578	195185	5/8	12	90	95	462270	1096609
12	RB	168044	195229	5/8	12	90	95	474141	1096609
12	BB	104345	105344	3/4	12	90	95	462289	1096609
12	RB	104363	105362	3/4	12	90	95	474150	1096609
14	BB	194621	195247	5/8	12	100	105	463625	1096609
14	RB	194649	195265	5/8	12	100	105	474766	1096609
14	BB	104425	105424	3/4	12	100	105	463634	1096609
14	RB	104443	105442	3/4	12	100	105	474775	1096609

* Ultimate Load is 4 times the Working Load Limit.

† Available in Bronze Bushed only.

‡ May be furnished in other Wire Rope sizes.

NOTE: When ordering, please specify: size, block number, hook or shackle, bronze bushed or roller bearing, and wire rope size.



McKissick® Snatch Blocks

Fatigue Rated



416 WITH HOOK



All Alloy Snatch Blocks

- Entire block made from heat treated alloy steel. Use of heat treated alloy gives block only 60% of the weight of blocks of comparable capacities.
- Available with a bronze bushed or roller bearing sheaves.
- Easy opening feature of "Champion" blocks retained.
- Hook and shackle assemblies can be interchanged.
- Pressure lube fittings.
- Can be furnished with S-4320 hook latch.
- Blocks furnished with dual rated wireline sheaves.
- Fatigue Rated.
- Meets or exceeds all requirements of ASME B30.26 including identification, ductility, design factor, proof load and temperature requirements. Importantly, these blocks meet other critical performance requirements including fatigue life, impact properties and material traceability, not addressed by ASME B30.26.
- All sizes are **RFID EQUIPPED**.

417 WITH SHACKLE



416 / 417 / 402 Alloy Snatch Blocks

Sheave Diameter (in.)	Bearing Code	Stock No.			Wire Rope Size (in.) †	Working Load Limit (t)*	Weight Each (lbs.)			Rep. Sheave Stock No.	Rep. Latch Stock No.
		416 with Hook	417 with Shackle	402 Tail Board			416 with Hook	417 with Shackle	402 Tail Board		
6	BB	193427	168972	179238	3/4 - 7/8	12	26	27	15	460824	1096609
6	RB	193472	193757	179283	3/4 - 7/8	12	26	27	15	472679	1096609
8	BB	193490	168990	179318	3/4 - 7/8	12	33	34	21	461173	1096609
8	RB	193542	193819	179363	3/4 - 7/8	12	33	34	21	473286	1096609
10	BB	193613	193882	179434	3/4 - 7/8	12	41	42	29	461814	1096609
10	RB	193677	193935	179498	3/4 - 7/8	12	41	42	29	473785	1096609

* Ultimate Load is 4 times the Working Load Limit.

† May be furnished in other wire rope sizes.

NOTE: When ordering, please specify: size, block number, hook or shackle, bronze bushed or roller bearing, and wire rope size.

NOTE: Tail board does not contain the spool that is required with the hook (416) and shackle (417) snatch blocks.

402 TAIL BOARD





McKissick® Oilfield Servicing Blocks

Fatigue Rated

434 WITH HOOK



All Alloy High Capacity Snatch Blocks

- Entire block made from heat treated alloy steel. Use of heat treated alloy gives block only 60% of the weight of blocks of comparable capacities.
- Available with bronze bushed sheaves.
- Easy opening feature of "Champion" blocks retained.
- Pressure lube fittings.
- Can be furnished with hook latch.
- Fatigue Rated.
- Meets or exceeds all requirements of ASME B30.26 including identification, ductility, design factor, proof load and temperature requirements. Importantly, these blocks meet other critical performance requirements including fatigue life, impact properties and material traceability, not addressed by ASME B30.26.
- All sizes are **RFID EQUIPPED**.



435 WITH SHACKLE



434 / 435 / 401 All Alloy High Capacity Snatch Blocks

Sheave Diameter (in.)	Bearing Code	Stock No.			Wire Rope Size (in.) ‡	Working Load Limit (t)*	Weight Each (lbs.)		
		434 with Hook	435 with Shackle	401 Tail Board			434 with Hook	435 with Shackle	401 Tail Board
8	BB	208894	168295	179149	1	25	90	102	50
8	BB	302522	302568	302602	1-1/8	25	90	102	50
10	BB	208901	208956	179158	1	25	107	118	65
10	BB	208910	208965	179167	1-1/4	25	107	118	65
10	BB	302531	302577	302611	1-1/8	25	107	118	65
12	BB	208929	208974	179176	1	30	165	182	95
12	BB	302540	302586	302620	1-1/8	30	165	182	95
14	BB	208938	208983	179185	1	30	180	198	110
14	BB	302559	302595	302639	1-1/8	30	180	198	110
12	BB	-	8027291	8027292	1-1/8	60	-	315	160

* Ultimate Load is 4 times the Working Load Limit.

‡ May be furnished in other wire rope sizes.

NOTE: When ordering, please specify: size, block number, hook or shackle, and wire rope size.

NOTE: Tail board does not contain the spool that is required with the hook (434) and shackle (435) snatch blocks.

For custom orders contact our Specials Sales Department or reference the special request form on page 453.

401 TAIL BOARD





Lebus® Snatch Blocks



Fatigue Rated

L-5-H



- Hook is Forged Alloy Steel – Quenched and Tempered.
- Designed for fast, efficient line changes.
- All parts are forged.
- Beaded side plate prevents rope from jamming.
- Available with hook, shackle or tailboard (pin only).
- Can be furnished with hook latch.
- Blocks furnished with dual rated wireline sheaves.
- Fatigue Rated.
- Meets or exceeds all requirements of ASME B30.26 including identification, ductility, design factor, proof load and temperature requirements. Importantly, these blocks meet other critical performance requirements including fatigue life, impact properties and material traceability, not addressed by ASME B30.26.

L-160 Series Heavy Duty Snatch Blocks

L-5-S



Block No.	Bearing Code	L-160 Stock No.	Fitting	Sheave Diam. (in.)	Working Load Limit (t)*	Wire Rope Size (in.)	Weight Each (lbs.)	Rep Sheave Stock No.	Rep. Latch Stock No.
L-5-H	BB	599506	Hook	5	6	3/8 - 1/2	15	592095	1096468
L-5-H	RB	599515	Hook	5	6	3/8 - 1/2	15	592157	1096468
L-5-S	BB	599524	Shackle	5	6	3/8 - 1/2	15	592095	-
L-5-S	RB	599533	Shackle	5	6	3/8 - 1/2	15	592157	-
L-5-T	BB	599542	Tailboard	5	6	3/8 - 1/2	10	592095	-
L-5-T	RB	599551	Tailboard	5	6	3/8 - 1/2	10	592157	-
L-6-H	BB	599560	Hook	5-7/8	12	5/8 - 3/4	32	592175	1096609
L-6-H	RB	599579	Hook	5-7/8	12	5/8 - 3/4	32	592255	1096609
L-6-S	BB	599588	Shackle	5-7/8	12	5/8 - 3/4	30	592175	-
L-6-S	RB	599597	Shackle	5-7/8	12	5/8 - 3/4	30	592255	-
L-6-T	BB	599604	Tailboard	5-7/8	12	5/8 - 3/4	18	592175	-
L-6-T	RB	599613	Tailboard	5-7/8	12	5/8 - 3/4	18	592255	-

* Ultimate Load is 4 times the Working Load Limit.

NOTE: When ordering, please specify: size, block number, hook or shackle, bronze bushed or roller bearing, and wire rope size.

NOTE: Tail board does not contain the spool that is required with the hook (L-5-H) and shackle (L-5-S) snatch blocks.

L-5-T





Lebus® Snatch Blocks



L-45-H



- Hook is Forged Alloy Steel – Quenched and Tempered.
- All parts are forged.
- Opened and closed in seconds without the use of tools.
- Available with hook, shackle or tail board (pin only).
- Either wire or manila rope may be used.
- Can be furnished with hook latch.
- Blocks furnished with dual rated wireline sheaves.
- Meets or exceeds all requirements of ASME B30.26 including identification, ductility, design factor, proof load and temperature requirements. Importantly, these blocks meet other critical performance requirements including fatigue life, impact properties and material traceability, not addressed by ASME B30.26.

L-170 Series General Purpose Snatch Blocks

Block No.	Bearing Code	L-170 Stock No.	Fitting	Sheave Diam. (in.)	Working Load Limit (t)*	Wire Rope Size (in.)	Manila Rope Size (in.)	Weight Each (lbs.)	Rep Sheave Stock No.	Rep. Latch Stock No.
L-45-H	BB	599800	Hook	4-1/8	5	3-8 - 1/2	1-1/4	13	460405	1096468
L-45-H	RB	599819	Hook	4-1/8	5	3/8 - 1/2	1-1/4	13	472580	1096468
L-45-S	BB	599828	Shackle	4-1/8	5	3/8 - 1/2	1-1/4	13	460405	-
L-45-S	RB	599837	Shackle	4-1/8	5	3/8 - 1/2	1-1/4	13	472580	-
L-45-T	BB	599846	Tail Board	4-1/8	5	3/8 - 1/2	1-1/4	9	460405	-
L-45-T	RB	599855	Tail Board	4-1/8	5	3/8 - 1/2	1-1/4	9	472580	-

* Ultimate Load is 4 times the Working Load Limit.

NOTE: When Ordering, specify either roller bearing or bronze bushed sheaves.

NOTE: Tail board does not contain the spool that is required with the hook (L-45-H) and shackle (L-45-S) snatch blocks.

L-45-S



L-45-T





Vertical Clamps

IPU10



The IPU10 vertical lifting clamp is used for the lifting, turning, moving or vertical transfer of sheet, plates, or fabrications from horizontal to vertical and down to horizontal (180°) as needed. The hinged hoisting eye allows for the clamp to place and lift the load from any direction, or with a multiple leg sling without side-loading the clamp.

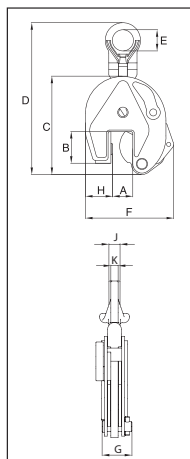

Universal - For Lifting in any Direction

- Available in capacities of .5 thru 30 metric tons (Higher Working Load Limits are available upon request).
- Wide variety of jaw openings available: 0" to 6.13"
- Welded alloy steel body for strength and smaller size. Forged alloy components, where required.
- Individually Proof Tested to 2 times the Working Load Limit with certification.
- Company name (CrosbyIP), logo, Working Load Limit and jaw opening permanently stamped on body.
- Each product is individually serialized, with the serial number and Proof Load test date stamped on body. Serial number is included on the test certificate with maintenance and warranty logbook.
- Available in a variety of styles:
 - IPU10 - Standard clamp for materials with a surface hardness to 37Rc (345HB)
 - IPU10J - Larger jaw opening.
 - IPU10S - For use with Stainless Steel material.
 - IPU10H - For use with materials with a surface hardness to 47Rc (450HB).
- Full 180° turning range for material transfer, turning or moving.
- Lock open, lock closed ability with latch for pretension on material and then release of material.
- Optional IP-5000 Stinger assembly available. Allows for easy connection between the clamp and hoist hook.
- Minimum WLL of 10% of Maximum WLL.
- Maintenance replacement kits are available.
- Manufactured by a ISO 9001 facility.
- All sizes are RFID EQUIPPED.

IPU10S



IPU10S: For use on Stainless Steel material.
IPU10H: For use on materials with a surface hardness to 47Rc (450 HB).



Load Rated

Model IPU10

Model	Working Load Limit (t)*	IPU10 Stock No.	Weight Each (lbs.)	Dimensions (in.)									
				Jaw A	B	C	D	E	F	G	H	J	K
IPU10	0.5	2701675	4.19	0 - .63	1.73	5.04	8.98	1.57	4.53	1.61	1.10	-	.43
IPU10	1	2701663	5.29	0 - .75	1.77	5.47	8.74	1.57	4.96	1.61	1.50	-	.43
IPU10	2	2701677	18.7	0 - 1.38	3.07	7.91	14.65	2.76	7.48	2.40	2.17	-	.63
IPU10	3	2701665	32.6	0 - 1.56	3.94	9.96	17.52	2.95	8.86	3.07	2.36	-	.79
IPU10	4.5	2701667	35.3	0 - 1.56	3.94	9.96	17.52	2.95	9.13	3.23	2.56	-	.79
IPU10	6	2701669	53.0	0 - 2.00	4.96	11.89	20.67	3.15	11.50	3.31	3.74	1.73	.79
IPU10/J	6	2702469	67.3	2.00 - 4.00	4.96	11.89	20.67	3.15	13.46	3.31	3.74	1.73	.79
IPU10	9	2701671	65.0	0 - 2.00	4.96	12.80	21.93	3.15	12.20	3.62	4.13	1.73	.79
IPU10/J	9	2701673	67.2	2.00 - 4.00	4.96	12.80	22.13	3.15	14.17	3.62	4.13	1.73	.79
IPU10	12	2701679	126	0 - 2.13	6.30	15.39	24.53	3.15	13.03	4.61	5.39	1.61	.98
IPU10/J	12	2701681	130	2.13 - 4.25	7.01	17.28	26.50	3.15	16.34	4.61	5.39	1.61	.98
IPU10	16	2701683	159	.25 - 2.50	7.01	18.31	28.90	3.46	15.63	4.69	6.02	1.77	.98
IPU10/J	16	2701685	187	2.50 - 5.00	8.19	20.51	31.10	3.46	18.58	4.69	6.34	1.77	.98
IPU10	22.5	2701687	280	.25 - 3.13	8.74	21.81	33.66	4.33	18.50	5.35	7.32	1.93	.98
IPU10/J	22.5	2701689	287	3.13 - 6.13	9.96	24.72	36.61	4.33	22.64	5.35	7.72	1.93	.98
IPU10	30	2701691	337	.25 - 3.13	8.74	21.46	33.86	4.33	18.50	5.98	7.32	2.13	1.18
IPU10/J	30	2701693	364	3.13 - 6.13	9.84	24.41	36.81	4.33	22.24	5.98	7.72	2.13	1.18
For stainless steel - with universal hoisting eye													
IPU10/S	0.5	2702275	4.19	0 - .63	1.73	5.04	8.98	1.57	4.53	1.61	1.10	-	.43
IPU10/S	1	2702263	4.63	0 - .75	1.77	5.47	8.74	1.57	4.96	1.61	1.50	-	.43
IPU10/S	2	2702277	16.8	0 - 1.38	3.07	7.91	14.65	2.76	7.48	2.40	2.17	-	.63
IPU10/S	3	2702265	32.7	0 - 1.56	3.94	9.96	17.52	2.95	8.86	3.07	2.36	-	.79
IPU10/S	4.5	2702267	35.3	0 - 1.56	3.94	9.96	17.52	2.95	9.13	3.23	2.56	-	.79
IPU10/S	6	2702269	53.0	0 - 2.00	4.96	11.89	20.67	3.15	11.50	3.31	3.74	1.73	.79
IPU10/S	9	2702271	65.1	0 - 2.00	4.96	12.80	21.93	3.15	12.20	3.62	4.13	1.73	.79
IPU10/S	12	2702279	67.3	0 - 2.13	6.30	15.39	24.53	3.15	13.03	4.61	5.39	1.61	.98
For very hard materials - with universal hoisting eye													
IPU10/H	0.5	2702175	4.19	0 - .63	1.73	5.04	8.98	1.57	4.53	1.61	1.10	-	.43
IPU10/H	1	2702177	16.8	0 - 1.38	3.07	7.91	14.65	2.76	7.48	2.40	2.17	-	.63
IPU10/H	2	2702165	32.7	0 - 1.56	3.94	9.96	17.52	2.95	8.86	3.07	2.36	-	.79
IPU10/H	3	2702167	35.3	0 - 1.56	3.94	9.96	17.52	2.95	9.13	3.23	2.56	-	.79
IPU10/H	4.5	2702169	53.0	0 - 2.00	4.96	11.89	20.67	3.15	11.50	3.31	3.74	1.73	.79
IPU10/H	6	2702171	65.1	0 - 2.00	4.96	12.80	21.93	3.15	12.20	3.62	4.13	1.73	.79

* Design Factor based on EN 13155 and ASME B30.20.

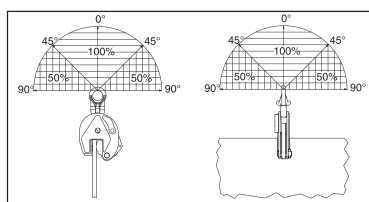
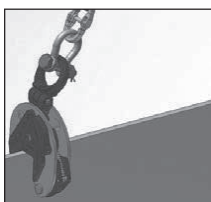



Vertical Clamps

IP10



The IP10 vertical lifting clamp is used for the lifting, turning, moving or vertical transfer of sheet, plates, or fabrications from horizontal to vertical and down to horizontal (180°) as needed. Usually used as a single point pick or when used with a spreader beam with multiple vertical drop lines.

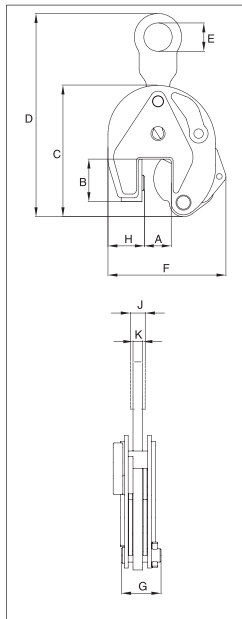

For Vertical Lifting, Turning and Transfer

- Available in capacities of .5 thru 30 metric tons (Higher Working Load Limits are available upon request).
- Wide variety of jaw openings available: 0" to 6.10".
- Welded alloy steel body for strength and smaller size. Forged alloy components, where required.
- Individually Proof Tested to 2 times the Working Load Limit with certification.
- Company name (CrosbyIP), logo, Working Load Limit and jaw opening permanently stamped on body.
- Each product is individually serialized, with the serial number and Proof Load test date stamped on body. Serial number is included on the test certificate with maintenance and warranty logbook.
- Available in a variety of styles:
 - IP10 - Standard clamp for materials with a surface hardness to 37Rc (345 HB).
 - IP10J - Larger jaw opening.
 - IP10S - For use with Stainless Steel material.
 - IP10H - For use with materials with a surface hardness to 47Rc (450 HB).
- Full 180° turning range for material transfer, turning or moving.
- Lock open, lock closed ability with latch for pretension on material and then release of material.
- Optional IP-5000 Stinger assembly available. Allows for easy connection between the clamp and hoist hook.
- Minimum WLL of 10% of Maximum WLL.
- Maintenance replacement kits are available.
- Manufactured by a ISO 9001 facility.
- All sizes are **RFID EQUIPPED**.



Model IP10

Model	Working Load Limit (t)*	IP10 Stock No.	Weight Each (lbs.)	Dimensions (in.)									
				Jaw A	B	C	D	E	F	G	H	J	K
IP10	0.5	2701674	3.97	0 - .63	1.73	5.04	8.15	1.18	4.53	1.61	1.10	-	.39
IP10	1	2701662	4.85	0 - .75	1.77	5.47	8.46	1.18	4.96	1.61	1.50	-	.39
IP10	2	2701676	16.8	0 - 1.38	3.07	7.91	13.23	2.76	7.48	2.40	2.17	-	.63
IP10	3	2701664	30.4	0 - 1.56	3.94	9.96	17.17	2.95	8.86	3.07	2.36	-	.79
IP10	4.5	2701666	33.1	0 - 1.56	3.94	9.96	17.17	2.95	9.13	3.23	2.56	-	.79
IP10	6	2701668	51.9	0 - 2.00	4.96	11.89	20.28	3.15	11.50	3.31	3.74	1.57	.79
IP10/J	6	2701705	62.9	2.00 - 4.00	4.96	11.89	20.28	3.15	13.46	3.31	3.74	1.57	.79
IP10	9	2701670	60.7	0 - 2.00	4.96	12.80	21.65	3.15	12.20	3.62	4.13	1.73	.79
IP10/J	9	2701672	62.9	2.00 - 4.00	4.96	12.80	21.85	3.15	14.17	3.62	4.13	1.73	.79
IP10	12	2701678	108	0 - 2.13	6.30	15.39	22.83	3.16	13.03	4.61	5.39	1.61	.98
IP10/J	12	2701680	128	2.13 - 4.25	7.01	17.28	24.80	3.15	16.34	4.61	5.39	1.61	.98
IP10	16	2701682	150	.25 - 2.50	7.01	18.31	27.17	3.46	15.63	4.69	6.02	1.93	.98
IP10/J	16	2701684	199	2.50 - 5.00	8.19	20.51	29.37	3.46	18.58	4.69	6.34	1.93	.98
IP10	22.5	2701686	238	.25 - 3.13	8.74	21.81	31.50	4.33	18.50	5.35	7.32	1.93	.98
IP10/J	22.5	2701688	243	3.13 - 6.10	9.96	24.72	34.65	4.33	22.64	5.35	7.72	1.93	.98
IP10	30	2701690	327	.25 - 3.13	8.74	21.46	31.50	4.33	18.50	5.98	7.32	2.13	1.18
IP10/J	30	2701692	335	3.13 - 6.10	9.84	24.41	34.65	4.33	22.24	5.98	7.72	2.13	1.18
For stainless steel - with fixed hoisting eye													
IP10/S	0.5	2702274	3.97	0 - .63	1.73	5.04	8.15	1.18	4.53	1.61	1.10	-	.39
IP10/S	1	2702262	4.41	0 - .75	1.77	5.47	8.46	1.18	4.96	1.61	1.50	-	.39
IP10/S	2	2702276	15.0	0 - 1.38	3.07	7.91	13.23	2.76	7.48	2.40	2.17	-	.63
IP10/S	3	2702264	30.5	0 - 1.56	3.94	9.96	17.17	2.95	8.86	3.07	2.36	-	.79
IP10/S	4.5	2702266	33.1	0 - 1.56	3.94	9.96	17.17	2.95	9.13	3.23	2.56	-	.79
IP10/S	6	2702268	51.9	0 - 2.00	4.96	11.89	20.67	3.15	11.50	3.31	3.74	1.57	.79
IP10/S	9	2702270	60.7	0 - 2.00	4.96	12.80	21.93	3.15	12.20	3.62	4.13	1.73	.98
IP10/S	12	2702278	108	0 - 2.13	6.30	15.39	24.53	3.15	13.03	4.61	5.39	1.61	.98
For very hard materials - with fixed hoisting eye													
IP10/H	0.5	2702174	3.97	0 - .63	1.73	5.04	8.15	1.18	4.53	1.61	1.10	-	.39
IP10/H	1	2702176	15.0	0 - 1.38	3.07	7.91	13.23	2.76	7.48	2.40	2.17	-	.63
IP10/H	2	2702164	30.4	0 - 1.56	3.94	9.96	17.17	2.95	8.86	3.07	2.36	-	.63
IP10/H	3	2702166	33.1	0 - 1.56	3.94	9.96	17.17	2.95	9.13	3.23	2.56	-	.79
IP10/H	4.5	2702168	51.9	0 - 2.00	4.96	11.89	20.28	3.15	11.50	3.31	3.74	1.57	.79
IP10/H	6	2702170	60.7	0 - 2.00	4.96	12.80	21.65	3.15	12.20	3.62	4.13	1.73	.98

* Design Factor based on EN 13155 and ASME B30.20.

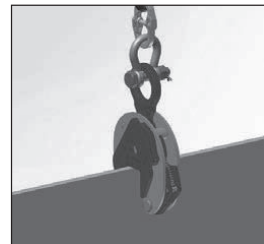
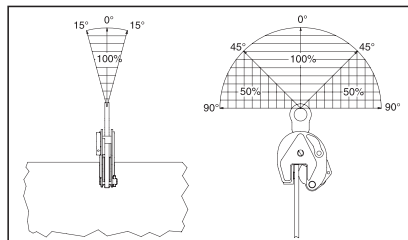



Crosby® Clamp-Co Padded Pipe Grab

CCPA



The new Crosby Clamp-Co Adjustable Pipe Grab provides an excellent means of handling cylindrical objects. Featuring padded grabs, the new Grab offers an excellent method of handling any pipe or solid bar, 3.5" to 36", especially where damage to material surface is not permitted.

- Capacities: 1,200 lbs. to 20,000 lbs.
- Each Grab size accommodates several diameters of pipe or solid bar.
- Auto indexing system provides quick connect and disconnect to load (one person - hands free).
- Individually Proof Tested to 2 times the Working Load Limit with certification.
- Designed to handle loads of various types of material, including:
 - Cast Iron / Steel
 - PVC
 - Painted
 - Epoxy Coated
- Finish - Red Paint
- Replacement pads are available.
- Features Crosby shackle as upper connection point.
- Custom sizes are available.
- All sizes are **RFID EQUIPPED**.



Padded Pipe Grab

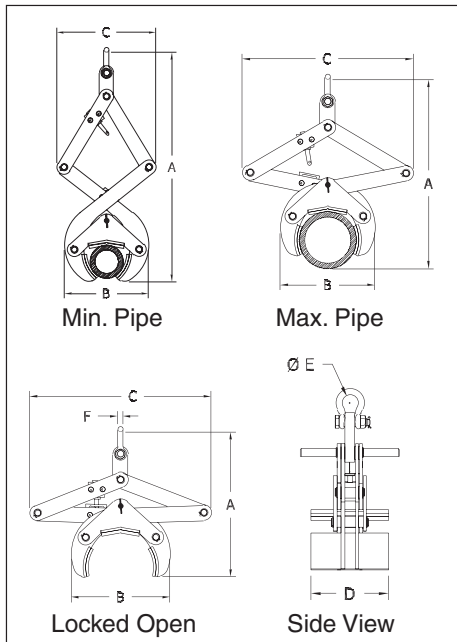

Model No.	CCPA Stock No.	Working Load Limit* (lbs.)	Weight Each (lbs.)	Grip Width	Dimensions (in.)					
					A	B	C	D	E	F
PA-5	2736000	1200	23	Locked	13.50	10.00	18.00	6.50	1.31	.50
				Open	27.00	9.00	8.00			
				Min. Pipe 3.50"	23.00	9.00	14.75			
PA-8	2736009	2000	75	Locked	23.50	15.50	27.75	10.00	1.69	.63
				Open	40.50	14.50	14.00			
				Min. Pipe 5.56"	34.00	14.75	24.00			
PA-14	2736018	4500	230	Locked	28.75	24.00	28.50	15.50	1.50	1.00
				Open	46.00	22.50	13.50			
				Min. Pipe 8.81"	34.00	23.00	26.00			
PA-22	2736027	10,000	496	Locked	42	36	42.5	20	2.5	1.5
				Open	67.5	34	19			
				Min. Pipe 14.00"	52	36	40			
PA-36	2736036	20,000	1250	Locked	57.27	57.03	57.31	30.00	3.37	1.50
				Open	92.02	52.38	26.98			
				Min. Pipe 24.00"	66.36	55.03	53.24			
				Max. Pipe 36.00"						

* Maximum Proof Load is 2 times the Working Load Limit and design factor based on EN13155 and ASME B30.20.



Crosby® Clamp-Co Pipe Grabs

CCPG

Crosby Clamp-Co Pipe Grabs provide an excellent means of handling cylindrical objects as long as they meet "Pipe O.D." and "Working Load Limits" referenced in the table below.

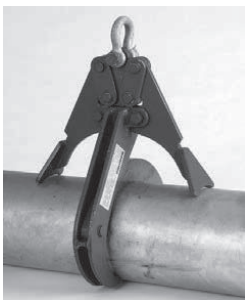

- Capacities: 450 lbs. to 7,000 lbs.
- Moveable outriggers help stabilize the load.
- No blocking of load required.
- Individually Proof Tested to 2 times the Working Load Limit with certification.
- Designed to handle loads of various types of material, including:
 - Cast Iron
 - Steel
 - PVC
 - C900
 - Yellowmine Ductile Iron
 - Cement Pipe
- Finish - Red Paint.
- Custom sizes are available.
- All sizes are **RFID EQUIPPED**.



NOTE: Pipe grab sizes listed will handle all classes in a category of ASA standard cast iron pipe, C900, Yellowmine, Schedule 40, 80 & 120 PVC or ASA standard steel welded and seamless pipe. Standard, extra strong and double extra all have the same outside diameter.

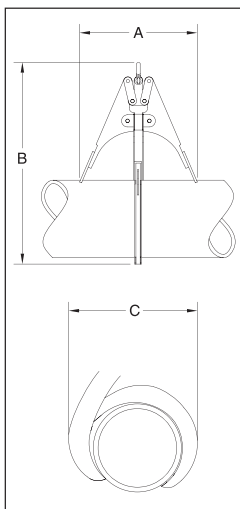

For Cast Iron Pipe

- C-900, C-905, Bluestripe C-906, Certa-Lok PVC Pressure Pipe

Model No.	CCPG- 900 Stock No.	Working Load Limit (lbs.)*	Pipe O.D. (in.)	Weight Each (lbs.)	Dimensions (in.)		
					A	B	C
C-3	2730000	450	4.00	10.0	5.00	10.00	6.00
C-4	2730009	600	4.80	11.0	8.00	14.00	7.00
C-6	2730018	1000	6.90	15.0	11.00	17.00	11.00
C-8	2730027	1400	9.05	25.0	13.00	22.00	14.00
C-10	2730036	2000	11.1	48.0	15.00	27.00	17.00
C-12	2730045	2500	13.2	72.0	18.00	32.00	20.00
C-14	2730054	3500	15.3	105	22.00	38.00	23.00
C-16	2730063	4000	17.4	130	24.00	42.00	25.00
C-18	2730072	5000	19.5	170	26.00	45.00	28.00
C-20	2730081	6500	21.6	210	28.00	50.00	32.00
C-24	2730090	7000	25.8	225	31.00	58.00	35.00

* Maximum Proof Load is 2 times the Working Load Limit and design factor based on EN13155 and ASME B30.20.

For Steel Pipe

- SDR Class 200, Yellowmine, PVC Schedule 40, 80 and 120

Model No.	CCPG- 200 Stock No.	Working Load Limit (lbs.)*	Pipe O.D. (in.)	Weight Each (lbs.)	Dimensions (in.)		
					A	B	C
S-3	2731000	450	3.50	10.0	5.00	10.00	6.00
S-4	2731009	600	4.50	11.0	8.00	14.00	7.00
S-6	2731018	1000	6.63	15.0	11.00	17.00	11.00
S-8	2731027	1400	8.63	25.0	13.00	22.00	14.00
S-10	2731036	2000	10.75	48.0	15.00	27.00	17.00
S-12	2731045	2500	12.75	72.0	18.00	32.00	20.00
S-14	2731054	3500	14.0	105	22.00	38.00	23.00
S-16	2731063	4000	16.0	130	24.00	42.00	25.00
S-18	2731072	5000	18.0	170	26.00	45.00	28.00
S-20	2731081	6500	20.0	210	28.00	50.00	32.00
S-24	2731090	7000	24.0	225	31.00	58.00	35.00

* Maximum Proof Load is 2 times the Working Load Limit and design factor based on EN13155 and ASME B30.20.



Crosby® Clamp-Co Beam Clamps

CCBC



Crosby Clamp-Co Beam Clamps provide an efficient method for handling wide flange beam sections and plate girders. When lifting, these beam clamps grip the beam at three points, and when properly balanced and safely guided, the beam can be handled even if the clamp is slightly off center lengthwise.

- Capacities: 5 Tons to 35 Tons
- Eliminates the need for slings, chokers, and spreader bars.
- When applied to load, the tongs automatically open and slide under the flange of the beam.
- Center plate and gripping tongs work together - the heavier the beam, the greater the clamping pressure.
- Model "NS" clamps have a recessed base to accept studs welded to the beam surface.
- Individually Proof Tested to 2 times the Working Load Limit with certification.
- Finish - Red Paint.
- All sizes are RFID EQUIPPED.



NOTE: Control the beam at all times. Beams should be gripped as near the center as possible. Snubbing lines at each end must be used to control excessive twisting or swinging, and to guide the beam to its proper place. Each lifting situation may have a specific demand which should be addressed before lifting.

Beam Clamps

Model No.	CCBC-500 Stock No.	Working Load Limit (Tons)*	Flange Grip Range (in.)		Weight Each (lbs.)	Dimensions (in.)									
			Width	Thickness		A	B	C	D	E	F	G	H	J	
F-5	2732000	5	4 - 10	.5 - 1	70.0	9.50	26.00	12.00	20.00	25.50	16.00	4.00	10.00	1.00	
F-15	2732009	15	7 - 17	.5 - 2	153	15.50	34.00	17.00	27.00	34.50	25.00	7.00	17.00	2.00	
NS-15	2732018	15	7 - 17	.5 - 2	153	15.50	34.00	17.00	27.00	34.50	25.00	7.00	17.00	2.00	
F-25	2732027	25	16 - 24	1 - 3	290	23.00	48.00	22.25	36.00	53.00	37.25	16.00	24.00	3.00	
NS-25	2732036	25	16 - 24	1 - 3	290	23.00	48.00	22.25	36.00	53.00	37.25	16.00	24.00	3.00	
F-35	2732045	35	16 - 36	1.63 - 4	519	30.00	64.00	27.50	48.00	58.00	53.00	16.00	36.00	4.00	
NS-35	2732054	35	16 - 36	1.63 - 4	519	30.00	64.00	27.50	48.00	58.00	53.00	16.00	36.00	4.00	

* Maximum Proof Load is 2 times the Working Load Limit and design factor based on EN13155 and ASME B30.20.
NOTE: : For beam clamps larger than 35 Tons, please contact the Crosby Special Engineered Products Department.

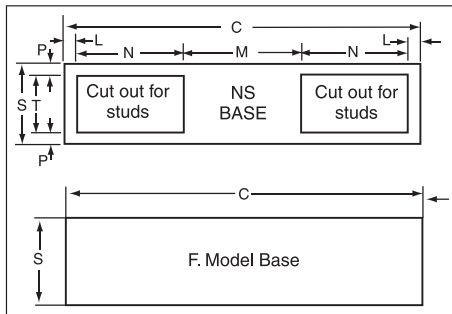
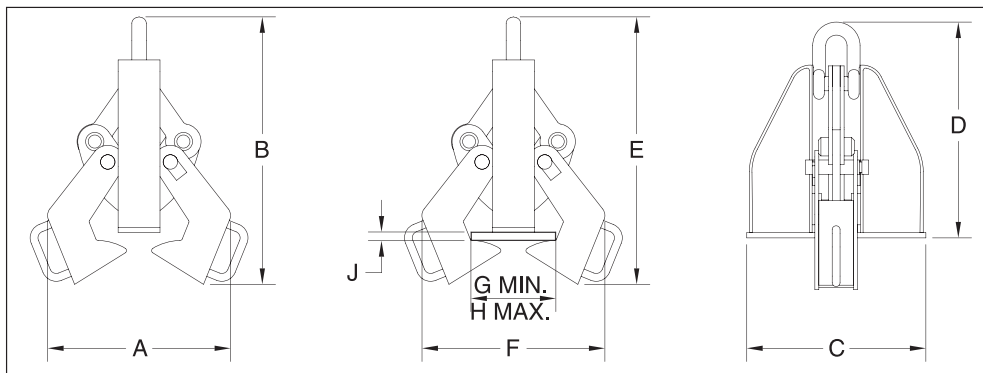

Base Stock No.	Base Dimensions (in.)						
	C	L	M	N	P	S	T
F-5	13.50	-	-	-	-	3.00	-
F-15	17.00	-	-	-	-	4.00	-
NS-15	17.00	.50	6.50	4.50	.75	4.00	2.50
F-25	22.25	-	-	-	-	5.50	-
NS-25	22.25	.75	7.75	6.50	.75	5.50	4.00
F-35	27.50	-	-	-	-	6.00	-
NS-35	27.50	.75	9.00	8.50	.75	6.00	4.50

Crosby® Clamp-Co Barrier / Curb Grabs

CCBG



Crosby Clamp-Co Barrier Grabs provide a fast and efficient method for handling concrete road barriers.

- Hands-free operation.
- Alloy Steel Construction.
- Available with polyurethane pads or hardened steel jaw (Replacement kits available).
- Eliminates the need for slings, chokers and spreader bars.
- Individually Proof Tested to 2 times the Working Load Limit with certification.
- Finish - Red Paint.
- All sizes are **RFID EQUIPPED**.

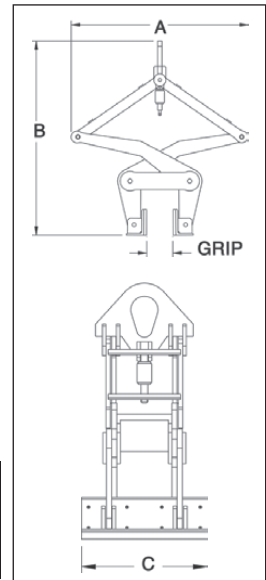

Barrier Grab

Model No.	CCBG-150 Stock No.	Working Load Limit (Tons)*	Weight Each (lbs.)	Grip Width (in.)	Dimensions (in.)		
					A	B	C
BG-9000	2734009	4.5	290	6 (min.)	40.88	44.88	18.00
				12 (max.)	44.00	36.75	18.00

* Design factor based on EN13155 and ASME B30.20.

CCGG



Crosby Clamp-Co Curb Grabs provide a fast and efficient method for handling large granite curbs.

- Virtually no manual assistance is required.
- Alloy Steel Construction.
- Available with polyurethane pads or hardened steel jaw (Replacement kits available).
- Eliminates the need for slings, chokers and spreader bars.
- Individually Proof Tested to 2 times the Working Load Limit with certification.
- Finish - Red Paint.
- All sizes are **RFID EQUIPPED**.

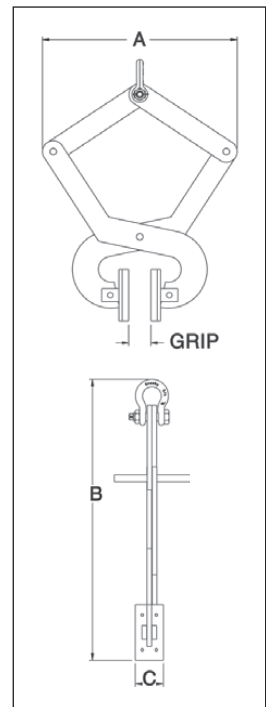

Curb Grab

Model No.	CCGG-140 Stock No.	Working Load Limit (lbs.)*	Weight Each (lbs.)	Grip Width (in.)	Dimensions (in.)		
					A	B	C
CG-1400	2734000	1400	290	4 (min.)	22.5	27.25	3.00
				7 (max.)	25.0	20.25	3.00

* Design factor based on EN13155 and ASME B30.20.



Crosby® Clamp-Co Pipe Hooks

CCPH

Crosby Clamp-Co Pipe Hooks provide a fast and efficient method for lifting pipe, tube or any similarly shaped fabrications.



- Alloy steel plate construction.
- Equipped with a convenient handle.
- Equipped with a Bolt Type Shackle.
- Non marring inserts available.
- Used in pairs with 45° - 60° horizontal angle or 60° - 90° included angle.

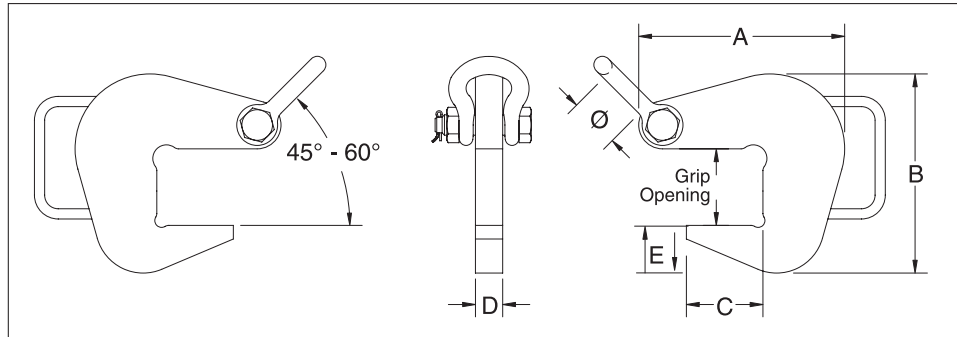

Pipe Hooks

Model	Stock No.	Working Load Limit Per Pair (t.)**	Grip (in.)	Weight Each (lbs.)	Dimensions (in.)						Shackle Size (in.)	Cast Aluminium Inserts*
					A	B	C	D	E	Ø		
PH-2	2734500	2	2.06	5.94	5.81	5.06	2.06	1.00	1.25	1.69	5/8	2734800 2734809
PH-4	2734509	4	2.81	10.03	7.56	7.31	2.81	1.00	1.75	1.69	5/8	2734818
PH-6	2734518	6	4.06	17.74	10.18	10.06	4.06	1.00	2.25	2.00	3/4	2734827
PH-10	2734527	10	6.06	38.67	14.81	15.06	6.06	1.00	3.50	2.69	1.0	2734836

* See CCPHI chart for Pipe ID range.
**Design factor based on EN13155 and ASME B30.20.

Pipe Hook Inserts

- Interchangeable cast aluminium inserts for use with the CCPH Pipe Hook that minimizes thread and pipe damage.

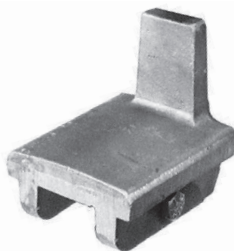

CCPHI

Catalog Number	Stock No.	ID of Pipe (in.)
CCPHI	2734800	3-12
	2734809	12-18
	2734818	18-30
	2734827	30-42
	2734836	42-72



Adjustable Length Lifting Beams with Swivel Hook bottoms

- Manufactured to exceed all ASME B30.20 and OSHA regulations.
- Painted safety yellow for increased visibility.
- **ALL** Lifting Beams proof loaded and shipped with certification paperwork.
- Durable construction ideally suited to jobsite or warehouse use.
- Made in U.S.A.
- Custom lettering available - call for details.
- Custom designs available - call for engineering.
- **ALL** lifting equipment individually proof loaded per OSHA requirements.
- All dimensions in inches unless otherwise noted.
- Quick and easy adjustment of unbalanced loads.
- Ideally suited to low headroom applications.
- Pictured with standard alloy swivel latch hooks.
- Eye hooks and custom connections available - call for ordering assistance.

RFID TRACKING



CHIP EQUIPPED

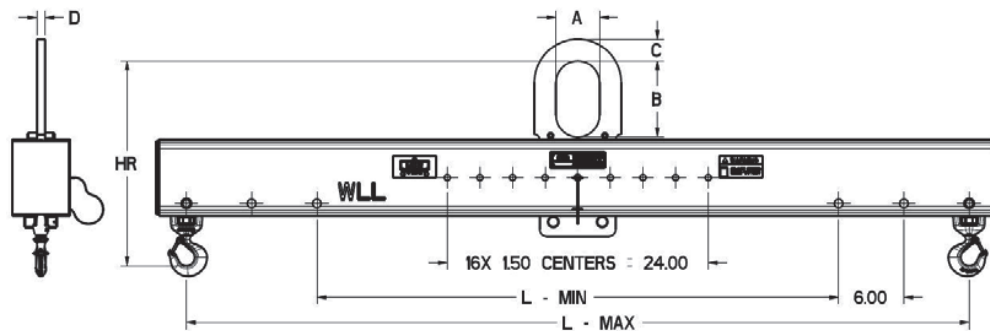

Working Load Limit in Pounds*	Part Number	L min	L max	A	B	C	D	HR	Weight in Pounds
2,000	16410	48	72	3	5	0.75	0.63	13.8	85
2,000	16411	120	144	3	5	0.75	0.63	15.7	285
4,000	16412	48	72	3	5	1.5	0.63	14.6	135
4,000	16413	120	144	3	5	1.5	0.63	16.6	330
6,000	16414	48	72	3	5	1.5	0.63	16.2	160
6,000	16415	120	144	3	5	1.5	0.63	19.1	530
8,000	16416	48	72	4	7	2	0.75	18.9	200
8,000	16417	120	144	4	7	2	0.75	20.9	540
10,000	16418	48	72	4	7	2	0.75	21.2	300
10,000	16419	120	144	4	7	2	0.75	22.2	795
15,000	16420	48	72	4	7	2	1.00	22.1	315
15,000	16421	120	144	4	7	2	1.00	25.1	815

* Call for specifications on larger sizes and capacities

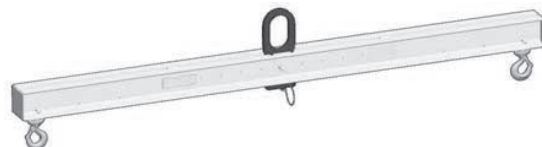



McKissick® Custom Sheaves

Customer Name:		Date:
Address:	City:	State, Zip:
Phone:	Fax:	E-Mail:
Customer Contact Name:		Quantity:

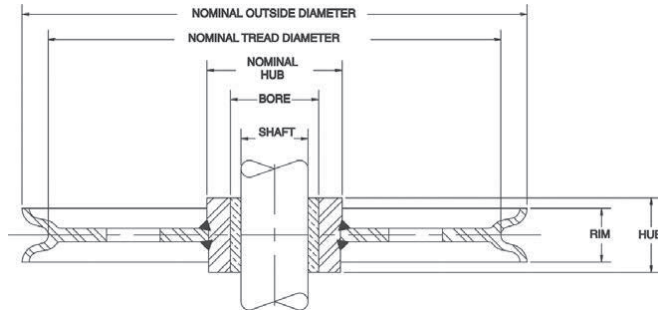

DIMENSIONAL INFORMATION

Nominal Outside Diameter: _____ Wire Rope Size: _____ Rim Width: _____
 + Shaft Size: _____ * Hub Width: _____
 Nominal Tread Diameter (Optional): _____ Nominal Hub Diameter (Optional): _____
+ Shaft size is bore size on Plain Bore Sheaves.
 * Hub width is measured over the cone of the Tapered Bearing Sheaves.

BEARING TYPE

<input type="checkbox"/> Bronze Bushing	<input type="checkbox"/> Ball Bearing
<input type="checkbox"/> Tapered Roller Bearing	<input type="checkbox"/> Finish / Plain Bore
<input type="checkbox"/> Roller Bearing (requires hardened and ground shaft)	<input type="checkbox"/> Underwater
<input type="checkbox"/> Full Complement Double-Row Cylindrical Roller Bearings with Seals	<input type="checkbox"/> Other

MATERIAL TYPE

<input type="checkbox"/> Roll Forged (Flame hardened 14" (356mm) and larger)	<input type="checkbox"/> Forged Steel
<input type="checkbox"/> Cast Steel	<input type="checkbox"/> Domed
<input type="checkbox"/> Fabricated	<input type="checkbox"/> Other

APPLICATION INFORMATION

Line Pull: _____ Fleet Angle: _____ Degree of Wrap: _____
 Line Speed: _____ Environment: _____ Groove Angle: _____

SPECIAL REQUIREMENTS

Special Testing: _____
 Finish: _____
 Third Party Inspection / Approval: _____
(If 3rd party inspection or approval is required, please contact Crosby Customer Service.)



Crosby® Custom Design Hooks

CROSBY CUSTOM MACHINED SHANK HOOK & NUT QUOTATION REQUEST FORM

Customer Name:		Date:
Address:		City, State, Zip
Phone:		Fax:
Customer Contact Name:		
Quotation Due Date:		Product Delivery Date:
Crosby / McKissick Proposal Number:		Quantity:

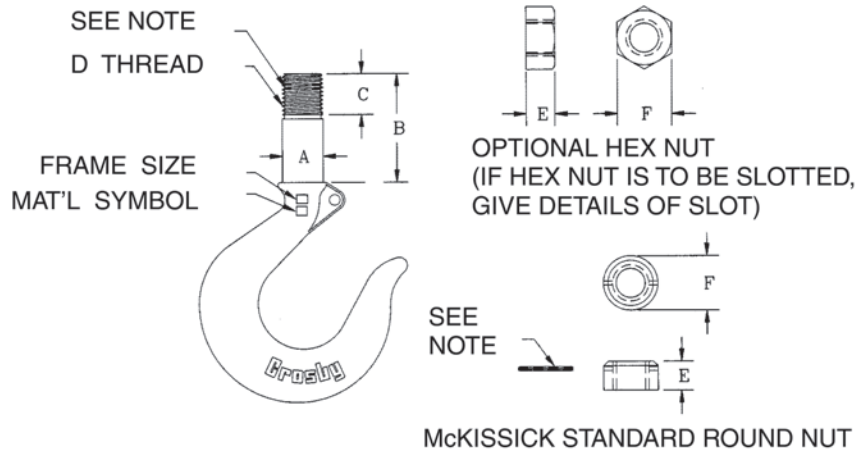

NOTE:
FOR INSTALLATION OF SPRING PIN, STANDARD PRACTICE
IS TO FIELD DRILL NUT AND SHANK AFTER ASSEMBLY
AND ADJUSTED TAKE-UP IS MADE.

Dimensions:	
Frame Size and material Symbol:	
Working Load Limit (tons)	
A.	Round or Hex Nut
B.	E.*
C.*	F.
D.	
	Hook Latch Kit
	_____ SS-4055 Flipper latch
	_____ PL Flapper latch
	_____ 4320 Latch
* The minimum thread length engaged in the nut should not be less than one (1) thread diameter.	
For additional information concerning customer design products, contact: In U.S.A. - Crosby's Special Engineered Products Group at 1-800-777-1555 In Canada - Crosby Canada at (905) 451-9261 In Europe - N.V. Crosby Europe at 32-15-757125 (26)	

6



Crosby® Swivel Hoist Ring Data Form

Specification sheet for Crosby HR125 & HR125M Hoist Rings
with optional bolt lengths

Date:	
CG #:	Crosby Quote Number:
Customer #:	Contact:
Distributor's Names:	Distributor's Fax Number:
Distributor's Phone Number:	Quantity Requested:
Distributor's P.O. #	Crosby Representative:

- Determine the *Type of Threads* required on the Hoist Ring - Metric or UNC, UNF, Etc. **NOTE - NOT DESIGNED FOR PIPE, ACME OR TAPERED THREADS.**
- Determine the *Working Load Limit* of the requested Hoist Ring.
- Determine *Bolt Diameter* - The diameter of the required bolt.
- Determine *Effective Thread Length* - This is the length the threads must be in order to fully engage, or project through, the work piece. **NOTE; If the Effective Thread Length is not known, the Length of Bolt is required.**
- Determine *Length of the Bolt* - The over all length of the bolt as measured from under the head of the bolt. **NOTE: If the Effective Thread Length is not known, the Length of the bolt is required.**
- # of Thread Threads per Inch (Length Between Threads for Metric threads)* - This information is required to ensure we ship proper bolt size (i.e., 1/2 - 13, 7/8 - 9, 8 x 1.25, etc.).

1. → **Thread Type (Circle One)**
 U.N.C. Thread
 Metric Thread
 Other
(NOT DESIGNED FOR PIPE, ACME, OR TAPERED THREADS)
2. → **Hoist Ring Capacity (Working Load Limit)**
 _____ lbs. Kgs.

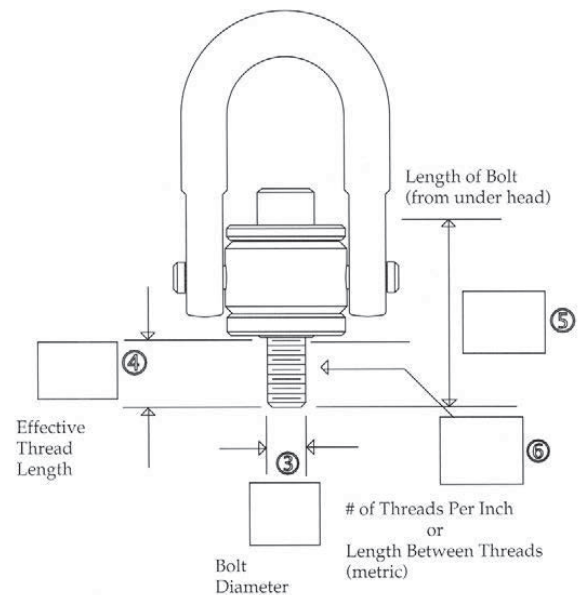



Crosby® / Bullard® Golden Gate® Hook

HOOK DATA FORM

Hook Size:	Name of Person Completing Form:
Sales Order:	
Working Load Limit (Tons)	Telephone:
Hoist Name and Model:	Distributor:
Top Hook <input type="checkbox"/> Bottom Hook <input type="checkbox"/>	Distributor P.O.:
Is Self-Closing Gate Required? Yes <input type="checkbox"/> No <input type="checkbox"/>	Accurate dimensions are important. If you have any questions, contact your authorized Crosby Distributor.

Shank Length

1. Measure total USABLE shank length from top of hook shank to top of gate assembly. Gate assembly is not considered part of the USABLE shank. When measuring other manufacturer's hooks, measure from the top of the hook shank to the hook shoulder.
2. Measure threaded portion (enter BLANK if threads not required). NOTE: Hook is supplied with Steel Hex-Load Nut and Bronze Load Washer. Hook and Nut threads are National Coarse. If a SPECIAL Load Nut or Load Washer is required, attach a drawing to this form.

Shank Diameter

3. Measure width of threaded portion.
4. Measure width of blank portion.

Throat Opening

5. ONLY measure throat opening if this distance is critical to customer's operation.

Cross Hole in Shank Hooks

(complete only if required)

6. Measure shank length from center of hole to top of gate assembly.
7. Measure diameter of hole.

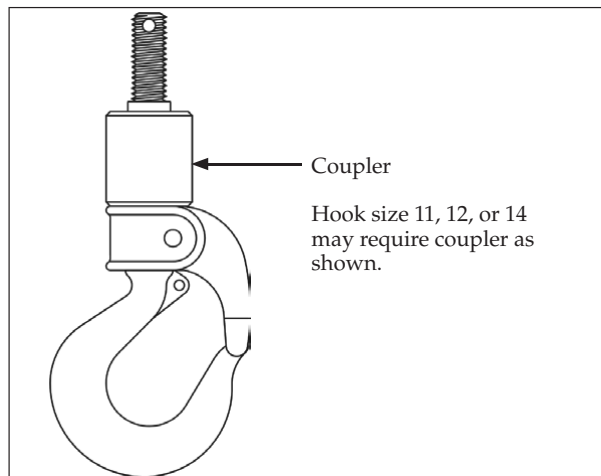
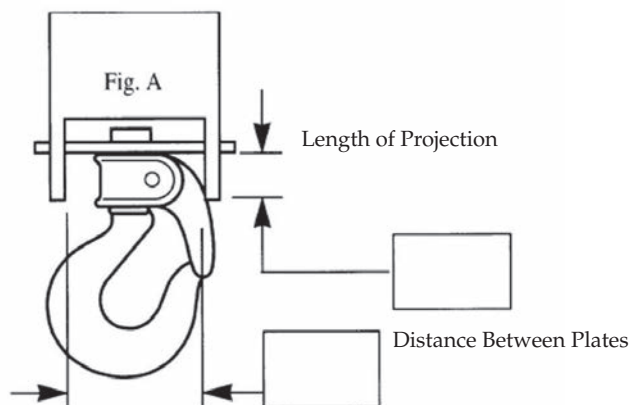
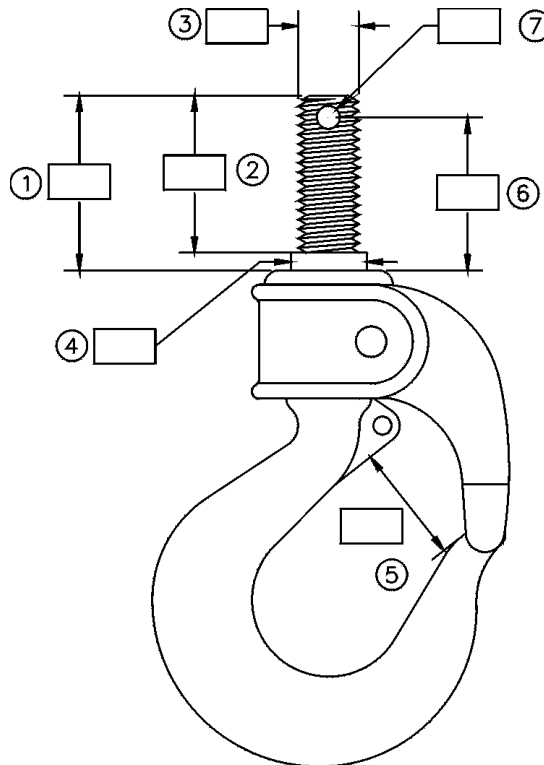

6



McKissick® Custom Design Hooks

McKissick® Duplex Hook Assemblies

- Cast alloy steel.
- Available in forged steel upon special request.
- Can be machined to optional dimensions upon request.
- Furnished complete with two flipper latches.
- The working load limits shown are in short tons and applicable for loading up to an included sling angle of 90 degrees. For included sling angles up to 60 degrees, the hooks can be rated in metric tons.

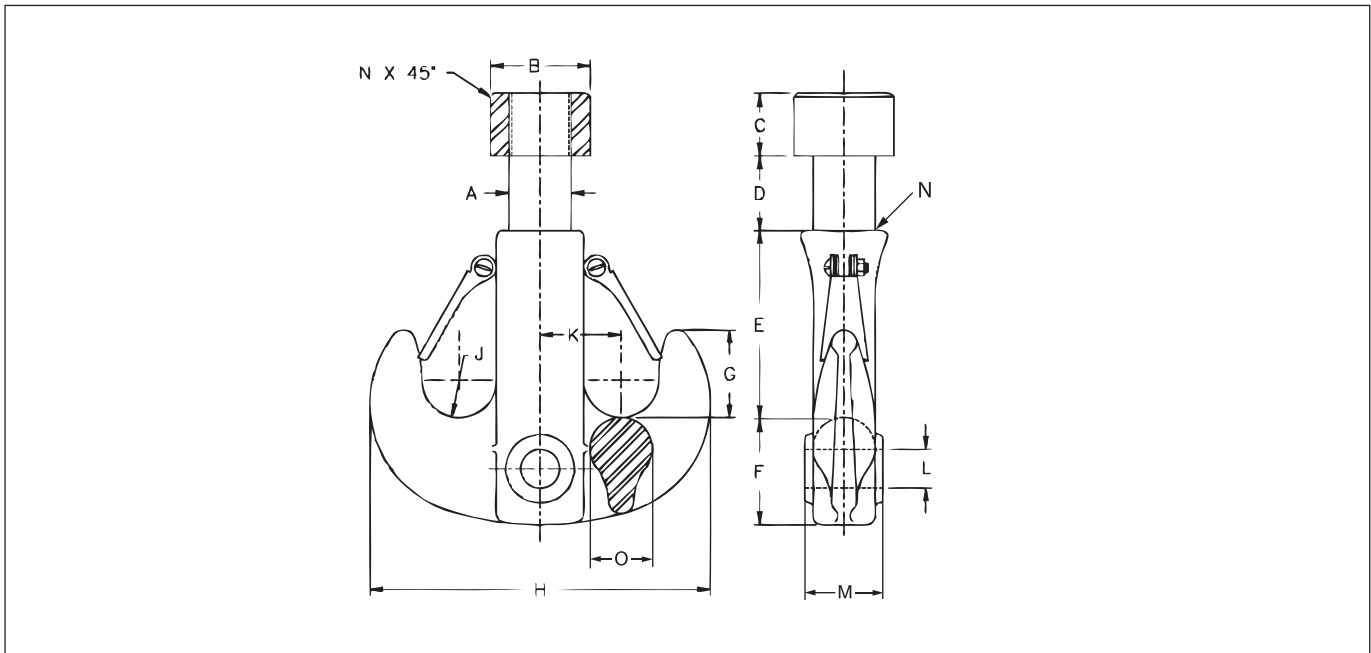

Duplex Hook with Nut and Latches Dimensions (in.)																	
Stock No. Hook Assembly	Size (tons)	A	B	C	D	E	F	G	H	J	K	L	M	N	O	Weight Each (lbs.)	Replacement Latch Kit Stock No.
127384	25	2.50	4.00	2.50	3.00	7.50	4.31	3.50	13.75	1.50	3.25	2.06	2.75	.12	2.50	62	1090143
126802	50	3.00	4.88	3.00	3.25	10.00	5.50	5.00	18.50	2.00	4.25	2.81	3.75	.25	3.50	136	1090189
137373	75	4.00	7.50	4.00	4.00	13.50	8.00	6.50	25.00	2.50	5.50	3.31	4.62	.25	4.50	311	1090223
137364	100	5.00	9.00	5.00	5.50	16.00	9.00	9.00	30.00	3.00	6.75	3.81	5.00	.25	5.00	532	1090223
137266	125	5.00	9.00	5.00	5.50	19.00	10.00	9.00	31.50	3.00	7.50	4.31	5.25	.25	5.00	844	1090223
137355	150	6.00	10.00	6.00	6.00	19.00	10.00	9.00	31.50	3.00	7.50	4.31	5.25	.12	5.00	844	1090223
137346	200	7.00	12.00	6.00	8.25	20.50	12.75	10.50	36.50	3.50	8.00	4.81	6.75	.25	6.00	1085	1090241
137337	250	8.00	14.00	7.00	9.00	23.75	14.00	11.75	40.00	3.75	8.75	5.12	8.00	.25	7.00	1635	1090241
137328	350	8.00	15.50	8.00	10.00	24.00	16.00	12.00	45.25	4.25	10.25	7.16	9.50	.25	9.00	2423	143080
2022897	500	10.00	18.00	8.25	16.75	26.50	18.50	12.25	45.00	4.50	10.00	7.16	9.50	.25	9.00	3300	8022575*
137319	600	10.00	18.00	8.25	8.75	25.00	18.00	14.00	51.00	5.00	11.00	7.94	9.75	.25	9.00	3120	143071
+2031520	1000	12.00	23.00	10.00	22.00	36.50	28.75	16.00	69.50	4.50	17.00	10.75	14.50	—	11.50	7800	8015361*

Ultimate Load is 4 times the Working Load Limit.

* Bolt style latch.

+ 1000 ton has different prong profile than shown.

For the purpose of calculating D/d ratio, utilize dimension O.

For additional information concerning custom design products, contact:

In U.S.A. — Crosby's Special Engineered Products Group at 1-800-777-1555, Fax (918) 834-5035.

In Canada — Crosby Canada at (905) 451-9261.

In Europe — N.V. Crosby Europe at 32 15 757125 (26).



Custom Split-Nut Hook for Mobile Cranes

Customer Name:		Date:
Address:		City, State, Zip Code:
Phone:		Fax:
Customer Contact Name:		Quantity:
		Requested Delivery Date:
- INTERNAL USE ONLY - Crosby / McKissick Proposal Number:		

Crosby McKissick® patented (U.S. Patent 7,000,905 and 7,293,763) Split-Nut Hook Retention System featured on McKissick® crane blocks makes inspection easier. The hook can be disassembled, inspected and put back into service in a fraction of the time of a conventional threaded nut.

Available Configurations									
319 Hook Type and Working Load Limit 4:1 Alloy (t)	Crosby Hook ID Code	"A" Available Shank Dia.		"B" Dimension		"C" Dimension		"D" Maximum Grip Length	
		(in.)	(mm)	(in.)	(mm)	(in.)	(mm)	(in.)	(mm)
15	L	1.75	44.4	1.62	41.1	3.25	82.5	5.38	137
22	N	2.00	50.8	1.62	41.1	3.50	88.9	5.38	137
30	O	2.50	63.5	2.31	58.7	4.38	111	15.69	398
37	P	2.50	63.5	2.31	58.7	4.38	111	21.69	551
45	S	3.00	76.2	2.75	69.9	5.50	140	21.25	540
60	T	3.00	76.2	2.75	69.9	5.50	140	23.25	591
75	U	4.00	102	3.75	95.2	7.50	190	19.25	489

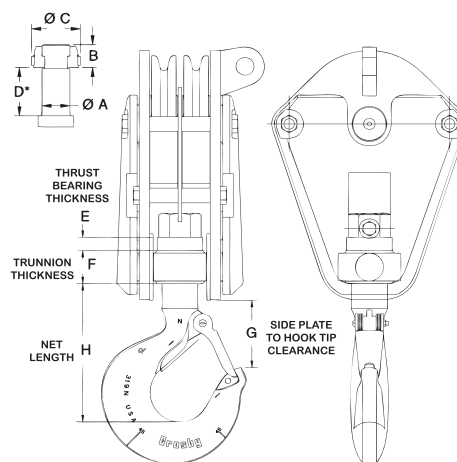

Steps to fit your block with the patented McKissick® Split-Nut Hook Retention System

1. Measure side plate to hook tip clearance and record in box "G" below. (The net length "H" dimension may be affected by holding the "G" dimension. If there is adequate clearance at tip of hook, the net length "H" dimension may be the dimension to specify).
2. Remove hook and thrust bearing from existing crane block.
3. Measure shank diameter and record in box "A" below.
4. Measure nut thickness and record in box "B" below. The standard "B" dimension (shown above) is a minimum and will be utilized unless actual measured "B" dimension is required.
5. Measure nut diameter and record in box "C" below. The standard "C" dimension (shown above) is a minimum and will be utilized.
6. Measure thrust bearing thickness and record in box "E" below. If known, record thrust bearing manufacturer and stock number below.
7. Measure trunnion thickness through the hook shank hole and record in box "F" within 1/32".
8. The required grip length "D" will be the addition of the "E" and "F" dimensions plus 0.06" for running clearance.
9. Determine the required hook size based on shank diameter and tonnage. Other shank /hook / tonnage combinations may be available. Your supplied information will be reviewed for the Split-Nut application.
10. Complete the form and forward to your local Authorized Distributor for quotation.

Thrust Bearing Standard							
Shank Ø		Bearing Outside Dia.		Bearing Thickness		Bearing Description	
(in.)	(mm)	(in.)	(mm)	(in.)	(mm)		
1.75	44.4	3.266	83.0	0.938	23.8	T-176	
2.00	50.8	3.672	93.3	1.062	26.9	T-202	
2.50	63.5	4.375	111	1.063	27.0	T-251	
3.00	76.2	5.250	133	1.313	33.4	T-301-W	
4.00	102	7.000	178	1.750	44.4	40-TP-114	

Required Dimensions

Frame Code or other distinguishable size designator:		Material Type: Check One: <input type="checkbox"/> Carbon <input type="checkbox"/> Alloy	
Working Load Limit: Check One: <input type="checkbox"/> Tons <input type="checkbox"/> Metric Tonnes		Thrust Bearing Identification:	
Check One:		Check One:	
Dimension A: <input type="checkbox"/> (in.) <input type="checkbox"/> (mm)	Dimension E: <input type="checkbox"/> (in.) <input type="checkbox"/> (mm)	Hook Latch Kit Check One: <input type="checkbox"/> SS-4055 Flipper latch <input type="checkbox"/> PL / PL-N Flapper latch <input type="checkbox"/> S-4320 Latch For personnel hoisting applications, only a PL, PL-N or S-4320 shall be utilized.	
Dimension B: <input type="checkbox"/> (in.) <input type="checkbox"/> (mm)	Dimension F: <input type="checkbox"/> (in.) <input type="checkbox"/> (mm)		
Dimension C: <input type="checkbox"/> (in.) <input type="checkbox"/> (mm)	Dimension G: <input type="checkbox"/> (in.) <input type="checkbox"/> (mm)		
Dimension D*: <input type="checkbox"/> (in.) <input type="checkbox"/> (mm)	Dimension H: <input type="checkbox"/> (in.) <input type="checkbox"/> (mm)		

*D = Bearing Thickness "E" + Trunnion Thickness "F" + .06" running clearance.

For additional information concerning customer design products, contact:
U.S.A. - Crosby's Special Engineered Products Group at 1-800-777-1555
Canada - Crosby Canada at (905) 451-9261
Europe - N.V. Crosby Europe at 32-15-757125 (26)



Cordage and Pull Tape





Cordage

Comparative Weight Strength and Working Load Chart

NOMINAL SIZE		MANILA			NYLON			POLYPROPYLENE		
Diameter	Circumference	Linear Density ¹ (Lbs/100ft)	Minimum Tensile Strength ² (Lbs.)	Max. Working ³ Load (Lbs.)	Linear Density ¹ (Lbs/100ft)	Minimum Tensile Strength ² (Lbs.)	Max. Working ³ Load (Lbs.)	Linear Density ¹ (Lbs/100ft)	Minimum Tensile Strength ² (Lbs.)	Max. Working ³ Load (Lbs.)
3/16	5/8	1.50	406	41	1.00	900	75	.70	720	72
1/4	3/4	2.00	540	54	1.50	1,490	124	1.20	1,130	113
5/16	1	2.90	900	90	2.50	2,300	192	1.80	1,710	171
3/8	1 1/8	4.10	1,220	122	3.50	3,340	278	2.80	2,440	244
7/16	1 1/4	5.25	1,580	176	5.00	4,500	410	3.80	3,160	352
1/2	1 1/2	7.50	2,380	264	6.50	5,750	525	4.70	3,780	420
9/16	1 3/4	10.4	3,100	388	8.15	7,200	720	6.10	4,600	575
5/8	2	13.3	3,960	496	10.5	9,350	935	7.50	5,600	700
3/4	2 1/4	16.7	4,860	695	14.5	12,800	1,420	10.7	7,650	1,090
13/16	2 1/2	19.5	5,850	835	17.0	15,300	1,700	12.7	8,900	1,270
7/8	2 3/4	22.4	6,950	995	20.0	18,000	2,000	15.0	10,400	1,490
1	3	27.0	8,100	1,160	26.4	22,600	2,520	18.0	12,600	1,800
1 1/16	3 1/4	31.2	9,450	1,350	29.0	26,000	2,880	20.4	14,400	2,060
1 1/8	3 1/2	36.0	10,800	1,540	34.0	29,800	3,320	23.8	16,500	2,360
1 1/4	3 3/4	41.6	12,200	1,740	40.0	33,800	3,760	27.0	18,900	2,700
1 5/16	4	47.8	13,500	1,930	45.0	38,800	4,320	30.4	21,200	3,020
1 1/2	4 1/2	60.0	16,700	2,380	55.0	47,800	5,320	38.4	26,800	3,820
1 5/8	5	74.5	20,200	2,880	66.5	58,500	6,500	47.6	32,400	4,620
1 3/4	5 1/2	89.5	23,800	3,400	83.0	70,000	7,800	59.0	38,800	5,550
2	6	108.	28,000	4,000	95.0	83,000	9,200	69.0	46,800	6,700
2 1/8	6 1/2	125.	32,400	4,620	109.	95,500	10,600	80.0	55,000	7,850
2 1/4	7	146.	37,000	5,300	129.	113,000	12,600	92.0	62,000	8,850
2 1/2	7 1/2	167.	41,800	5,950	149.	126,000	14,000	107.	72,000	10,300
2 5/8	8	191.	46,800	6,700	168.	146,000	16,200	120.	81,000	11,600
2 7/8	8 1/2	215.	52,000	7,450	189.	162,000	18,000	137.	91,000	13,000
3	9	242.	57,500	8,200	210.	180,000	20,000	153.	103,000	14,700
3 1/4	10	298.	69,500	9,950	264.	226,000	25,200	190.	123,000	17,600
3 5/8	11	366.	82,000	11,700	312.	270,000	30,000	232.	146,000	20,800
4	12	434.	94,500	13,500	380.	324,000	36,000	276.	171,000	24,000
4 1/4	13				445.	380,000	42,200	325.	202,000	28,900
4 1/2	14				520.	441,000	49,000	375.	234,000	33,400
5	15				590.	507,000	56,300	430.	268,000	38,300
5 1/4	16				675.	572,000	63,600	490.	302,000	43,100
5 5/8	17				765.	635,000	70,600	555.	329,000	47,000
6	18				860.	698,000	77,600	625.	360,000	51,400

NOTES:

1. LINEAR DENSITY: (pounds per 100 feet) shown is "average." Maximum is 5% higher.
2. NEW ROPE TENSILE STRENGTHS: are based on tests of new and unused rope of standard construction in accordance with Cordage Institute Standard Test Methods.
3. MAX. WORKING LOADS: are for rope in good condition with appropriate splices in noncritical applications, and under normal service conditions. Working loads should be reduced where life, limb, or valuable property are involved, or for exceptional service conditions such as shock loads, sustained loads, etc.

These specifications are for 3-strand laid standard ropes. Four-strand ropes weigh approximately 7% more and breaking tests are approximately 5% less than 3-strand ropes.

CAUTION!

1. Working loads are recommended guidelines only.
2. Specs are based on test of new and unused ropes of current manufacturers.
3. Once rope is put into service it is continuously deteriorating.
4. Manila and sisal rope will deteriorate in storage even under ideal conditions.



Industrial Wire Rope Supply Co., Inc.

Cincinnati Division

7390 Harrison Avenue
Cincinnati, Ohio 45247
Phone: (513) 941-2443
Fax: (513) 941-2445
Toll Free: (888)-345-0919

St. Charles Division

2086 Exchange Drive
St. Charles, Missouri 63303
Phone: (636) 255-0600
Fax: (636) 255-0602
Toll Free: (866) 852-9714

**DOUBLE BRAID POLYESTER
STANDARD WHITE / GREEN TRACER**

Diameter	Diameter in MM	Circumference	LBS/100 Feet	KGS/100 Meters	Approx. Tensile in LBS	Approx. Tensile In KG
1/4"	6	3/4"	2.00	3.0	1900	856
5/16"	8	1	3.50	5.2	3200	1441
3/8"	10	1 1/8"	4.40	6.6	4200	1892
7/16"	11	1 5/16"	6.70	10.0	6000	2703
1/2"	12	1 1/2"	8.20	12.2	7500	3378
9/16"	14	1 3/4"	9.70	14.5	9500	4279
5/8"	16	2"	13.00	19.4	12700	5721
3/4"	18	2 1/4"	17.50	26.1	18800	8468
7/8"	22	2 3/4"	23.30	34.7	27660	12459
1"	24	3"	30.50	45.4	31000	13964
1 1/8"	28	3 1/2"	40.00	59.6	40650	18311
1 1/4"	30	3 3/4"	49.00	73.0	49000	22072
1 5/16"	32	4"	55.00	82.0	55000	24775
1 1/2"	36	4 1/2"	64.00	95.0	70500	31725
1 5/8"	40	5"	82.00	122.2	89600	33558
1 3/4"	44	5 1/2"	95.00	141.6	103800	38626
2"	48	6"	124.00	184.8	126000	46846
2 1/8"	50	6 1/2"	137.00	204.0	143000	64414
2 1/4"	56	7"	153.00	339.0	160000	72072
2 1/2"	60	7 1/2"	189.00	281.0	181000	81531

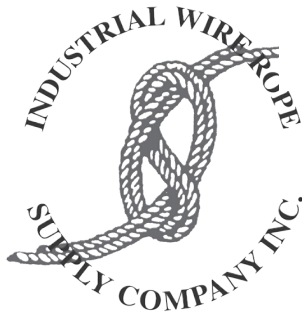

Industrial Wire Rope Supply Co., Inc.

Cincinnati Division
 7390 Harrison Avenue
 Cincinnati, Ohio 45247
 Phone: (513) 941-2443
 Fax: (513) 941-2445
 Toll Free: (888)-345-0919

St. Charles Division
 2086 Exchange Drive
 St. Charles, Missouri 63303
 Phone: (636) 255-0600
 Fax: (636) 255-0602
 Toll Free: (866) 852-9714

Double Braid Nylon

KEY BENEFITS:

- High strength
- High energy absorption and elasticity.

For mooring, anchoring, towing and any other application that requires controlling sudden shock loading. Meets or Exceeds US Military Specifications # Mil-DTL-24050 E and Canadian Military Specifications 40-16-95 Type 1. Specific Gravity 1.14.

Standard White/Blue Tracer, Also available in Red, Blue, Black, Green and Gold.

Diameter	Diameter in MM	Circumference	LBS/100 Feet	KGS/100 Meters	Approx. Tensile in LBS	Approx. Tensile In KG
1/4"	6	3/4"	1.7	2.5	2170	984
5/16"	8	1	2.5	3.7	3090	1401
3/8"	10	1 1/8"	3.4	5.1	4220	1914
7/16"	11	1 5/16"	5.3	7.8	5400	2449
1/2"	12	1 1/2"	6.3	9.3	7200	3265
9/16"	14	1 3/4"	7.8	11.7	10500	4729
5/8"	16	2"	10.8	16.1	14000	6349
3/4"	18	2 1/4"	14.2	21.1	20000	9070
7/8"	22	2 3/4"	20.0	29.8	28000	12698
1"	24	3"	25.0	37.2	33500	15193
1 1/8"	28	3 1/2"	33.3	49.6	47000	21171
1 1/4"	30	3 3/4"	39.2	58.3	53000	23873
1 5/16"	32	4"	44.2	65.7	56940	25823
1 1/2"	36	4 1/2"	53.3	79.4	72500	32658
1 5/8"	40	5"	67.5	100.5	88000	39639
1 3/4"	44	5 1/2"	82.0	122.0	105000	47297
2"	48	6"	97.0	144.4	125000	56306
2 1/8"	52	6 1/2"	114.0	169.7	143000	64414
2 1/4"	56	7"	132.0	196.4	165000	74324
2 1/2"	60	7 1/2"	152.0	226.2	185000	83333
2 5/8"	64	8"	173.0	257.5	201000	91172



12
STRAND
CONSTRUCTION

AmSteel®-Blue Product Code: 872

Class II

Recognized worldwide as the standard for single braid HMPE ropes

FEATURES AND BENEFITS:

- > Made with Dyneema®
- > Wire rope replacement
- > Size for size as strong as wire
- > 1/7th the weight of wire
- > Similar elastic elongation to wire rope
- > Torque free
- > Flexible
- > Easy to inspect
- > Easy to splice in the field
- > Floats

AmSteel®Blue is a torque-free 12-strand single braid that, size-for-size, is as strong as steel and lasts up to three times longer in certain applications, making it an excellent wire rope replacement. At only 1/7th the weight of wire, it is a safe and efficient solution for all applications where wire is traditionally used. The combination of Dyneema® fiber and Samthane coating provide abrasion and tension fatigue resistance for superior wear. AmSteel®Blue is easily spliced and inspected.



Dyneema® is a registered trademark of Royal DSM N.V. Dyneema is DSM's high-performance polyethylene product.

SIZE DIAMETER INCHES	SIZE CIRC. INCHES	WEIGHT PER 100 FT. POUNDS	SAMSON MBS* POUNDS	SIZE DIAMETER MILLIMETERS	WEIGHT PER 100 m KILOGRAMS	SAMSON MBS* KILOGRAMS	BS EN ISO 2307:2010 STRENGTH** METRIC TONS
7/64***	5/16"	0.30 lb	1,400 lb	2.5**mm	0.45 kg	650 kg	0.73 t
1/8"	3/8"	0.50 lb	2,300 lb	3 mm	0.74 kg	1,000 kg	1.1 t
5/32"	15/32"	0.75 lb	3,600 lb	4 mm	1.1 kg	1,600 kg	1.8 t
3/16"	9/16"	1.0 lb	4,900 lb	5 mm	1.5 kg	2,200 kg	2.4 t
1/4"	3/4"	1.6 lb	7,700 lb	6 mm	2.4 kg	3,500 kg	3.9 t
5/16"	1"	2.7 lb	12,300 lb	8 mm	4.0 kg	5,600 kg	6.2 t
3/8"	1-1/8"	3.6 lb	17,600 lb	9 mm	5.4 kg	8,000 kg	8.9 t
7/16"	1-1/4"	4.2 lb	21,500 lb	11 mm	6.2 kg	9,800 kg	10.8 t
1/2"	1-1/2"	6.4 lb	30,600 lb	12 mm	9.5 kg	13,900 kg	15.4 t
9/16"	1-3/4"	7.9 lb	36,500 lb	14 mm	11.8 kg	16,500 kg	18.4 t
5/8"	2"	10.2 lb	47,500 lb	16 mm	15.2 kg	21,600 kg	24.0 t
3/4"	2-1/4"	13.3 lb	58,000 lb	18 mm	19.8 kg	26,300 kg	29.2 t
13/16"	2-1/2"	17.0 lb	73,800 lb	20 mm	25.3 kg	33,500 kg	37.2 t
7/8"	2-3/4"	19.6 lb	81,700 lb	22 mm	29.2 kg	37,100 kg	41.2 t
1"	3"	21.8 lb	98,100 lb	24 mm	32.4 kg	44,500 kg	49.4 t
1-1/16"	3-1/4"	27.5 lb	118,000 lb	26 mm	40.9 kg	53,500 kg	59.4 t
1-1/8"	3-1/2"	31.9 lb	133,000 lb	28 mm	47.5 kg	60,400 kg	67.1 t
1-1/4"	3-3/4"	36.2 lb	149,000 lb	30 mm	53.9 kg	67,400 kg	74.8 t
1-5/16"	4"	41.8 lb	166,000 lb	32 mm	62.2 kg	75,100 kg	83.5 t
1-3/8"	4-1/8"	45.0 lb	185,000 lb	34 mm	67.0 kg	83,700 kg	93.0 t
1-1/2"	4-1/2"	51.7 lb	205,000 lb	36 mm	76.9 kg	93,100 kg	103 t
1-9/16"	4-3/4"	57.6 lb	229,000 lb	38 mm	85.7 kg	104,000 kg	115 t
1-5/8"	5"	65.2 lb	255,000 lb	40 mm	97.0 kg	116,000 kg	128 t
1-11/16"	5-1/4"	71.0 lb	276,000 lb	42 mm	106 kg	125,000 kg	139 t
1-3/4"	5-1/2"	78.4 lb	302,000 lb	44 mm	117 kg	137,000 kg	152 t
2"	6"	87.0 lb	343,000 lb	48 mm	129 kg	155,000 kg	173 t
2-1/16"	6-1/4"	95.0 lb	376,000 lb	50 mm	141 kg	171,000 kg	190 t
2-1/8"	6-1/2"	109 lb	411,000 lb	52 mm	162 kg	187,000 kg	207 t
2-1/4"	7"	116 lb	483,000 lb	56 mm	173 kg	219,000 kg	244 t
2-1/2"	7-1/2"	148 lb	529,000 lb	60 mm	220 kg	240,000 kg	267 t
2-5/8"	8"	167 lb	596,000 lb	64 mm	248 kg	270,000 kg	300 t
2-3/4"	8-1/2"	187 lb	662,000 lb	68 mm	278 kg	300,000 kg	333 t
3"	9"	206 lb	749,000 lb	72 mm	307 kg	340,000 kg	377 t
3-1/8"	9-1/2"	228 lb	828,000 lb	76 mm	339 kg	376,000 kg	417 t
3-1/4"	10"	240 lb	906,000 lb	80 mm	357 kg	411,000 kg	457 t
3-3/8"	10-1/8"	265 lb	1,008,000 lb	82 mm	394 kg	457,000 kg	508 t
3-1/2"	10-1/2"	295 lb	1,053,000 lb	86 mm	439 kg	478,000 kg	531 t
3-5/8"	11"	340 lb	1,313,000 lb	88 mm	506 kg	596,000 kg	662 t
3-3/4"	11-1/4"	362 lb	1,464,000 lb	92 mm	539 kg	664,000 kg	738 t
4"	12"	399 lb	1,637,000 lb	96 mm	594 kg	743,000 kg	825 t
4-1/4"	13"	452 lb	1,826,000 lb	104 mm	673 kg	828,000 kg	920 t
4-1/2"	13-1/2"	504 lb	2,021,000 lb	110 mm	750 kg	917,000 kg	1,019 t
4-5/8"	14"	551 lb	2,216,000 lb	112 mm	820 kg	1,005,000 kg	1,117 t
5"	15"	609 lb	2,421,000 lb	120 mm	906 kg	1,098,000 kg	1,220 t

SPECIFICATIONS¹

FIBER: Dyneema®

SPECIFIC GRAVITY: 0.98 (floats)

STANDARD COLOR: Blue (also available by special order in red, green, and orange)

ELASTIC ELONGATION PERCENTAGE

At % of break strength

10% 0.46%

20% 0.70%

30% 0.96%

SPLICE/CLASS: 12-strand Class II

¹Due to our continued research and development of product performance, the specifications listed herein are subject to change. For the most current sizes, weights, and strengths, go to SamsonRope.com.

*Spliced strength. ** Size 7/64" (2.5 mm) changes from 12-strand to 8-strand construction. ***This standard replaces BS EN 919:1995 and BS EN ISO 2307:2005.

Published Date: November 2012
DOCUMENT DS_AmSteel-Blue_ALL_SIZES_Nov2012.pdf

2090 Thornton Street, Ferndale, WA 98248 USA
Tel 01.360.384.4669 | Fax 01.360.384.0572
www.SamsonRope.com

© 2012 Samson Rope Technologies, Inc.
S.W.D #108389 11/2012



SAMSON
THE STRONGEST NAME IN ROPE



Industrial Wire Rope Supply Co., Inc.

Cincinnati Division

7390 Harrison Avenue
Cincinnati, Ohio 45247
Phone: (513) 941-2443
Fax: (513) 941-2445
Toll Free: (888)-345-0919

St. Charles Division

2086 Exchange Drive
St. Charles, Missouri 63303
Phone: (636) 255-0600
Fax: (636) 255-0602
Toll Free: (866) 852-9714

HERCULINE® is the premium choice for underground measuring and pulling of fiber optic and other lightweight cables. Specifically designed for the telecommunications, power utility and CATV industries, HERCULINE® can be easily blown through innerduct to provide smooth, safe pulls. Durable footmarkings allow for accurate measurement while flat construction and specially formulated lubricants work to minimize friction and duct cutting.

POLYESTER HERCULINE®					
Item No.	Tensile	Width	Construction	Prelubrication	Footmarkings
P160S	160 lbf	3/16"	Stranded	No	Yes
P400W	400 lbf	1/4"	Woven	No	Yes
P900W	900 lbf	3/8"	Woven	No	Yes
P1100W	1100 lbf	1/2"	Woven	No	No
P1250W	1250 lbf	1/2"	Woven	No	Yes
P1800W	1800 lbf	5/8"	Woven	No	Yes
P2500W	2500 lbf	3/4"	Woven	No	Yes

All products are available by special request with or without lubricant and with or without footmarkings. HERCULINE® is also available by request with metric markings.

KEVLAR* HERCULINE®					
Item No.	Tensile	Width	Construction	Prelubrication	Footmarkings
A900W	900 lbf	1/4"	Woven	No	Yes
A1250W	1250 lbf	1/4"	Woven	No	Yes
A1800W	1800 lbf	3/8"	Woven	No	Yes
A2500W	2500 lbf	1/2"	Woven	No	Yes

*Kevlar is a registered trademark of E.I. Du Pont

DETECTABLE POLYESTER HERCULINE®					
Item No.	Tensile	Width	Construction	Prelubrication	Footmarkings
P1250T	1250 lbf	1/2"	Woven	No	Yes
P1800T	1800 lbf	5/8"	Woven	No	Yes
P2500T	2500 lbf	3/4"	Woven	No	Yes

Detectable HERCULINE® features a corrosion resistant 22 gauge solid copper wire woven directly into the pulling tape to detect underground conduit and dielectric cable.

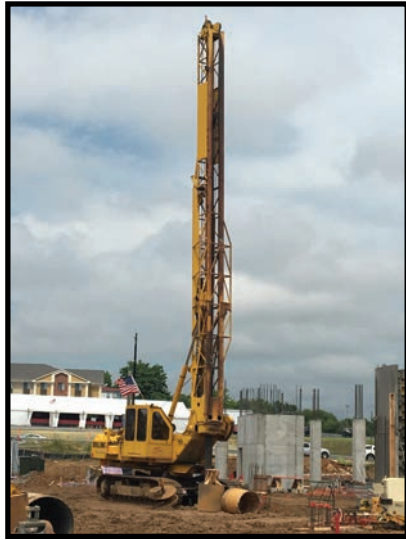



Distributed By: